





-  Valvola a sfera in 3 pezzi in acciaio inox AISI 316  
Attacchi Flangiati
-  AISI 316 stainless steel three-piece ball valve  
Flanged ends
-  Dreiteiliger Kugelhahn aus Edelstahl AISI 316  
Flanschanschlüsse
-  Vanne à boisseau sphérique en trois pièces en acier  
inox AISI 316 - fixations brides
-  Трёхсоставной кран из нержавеющей стали AISI 316  
Фланцевое соединение



ITEM	PART NAME	MATERIAL	QTY
1	Corpo - Body	CF8M	1
2	Seggio Sfera - Ball Seat	R-PTFE (15%)	2
3	Sfera - Ball	SS316	1
4	Guarnizione Corpo - Body Gasket	PTFE	2
5	Manicotto - Body End	CF8M	2
6	Rondella a molla - Spring Washer	SS304	8(12)
7	Dado - Nut	SS304	8(12)
8	Bullone - Bolt	SS304	4(6)
9	Asta - Stem	SS316	1
10	Rondella - Thrust Washer	PTFE	1
11	Guarnizione Asta - Stem Packing	PTFE	1
12	Dado premistoppa - Gland Nut	SS304	1
13	Leva - Handle	SS304	1
14	Rondella - Plate Washer	SS304	1
15	Dado - Nut	SS304	1
16	Dispositivo di blocco - Lock Device	SS304	1
17	Rivestimento Plastico - Plastic Cover	PLASTIC	1

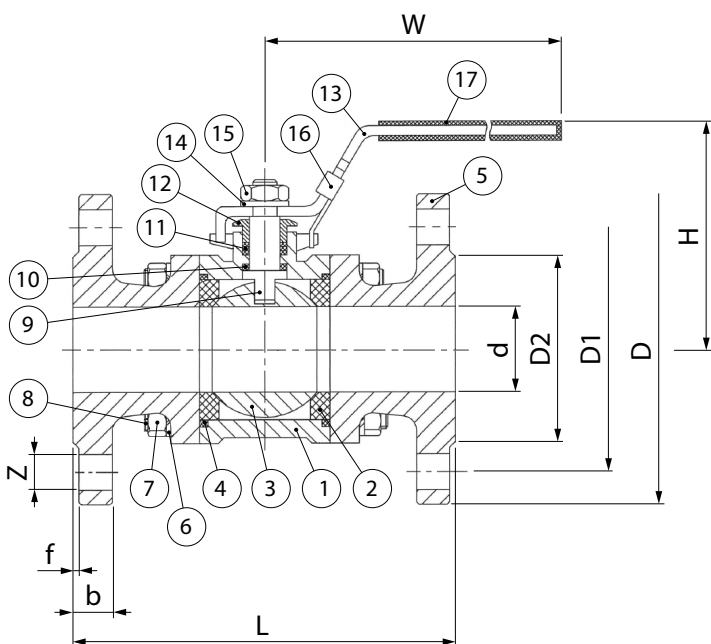
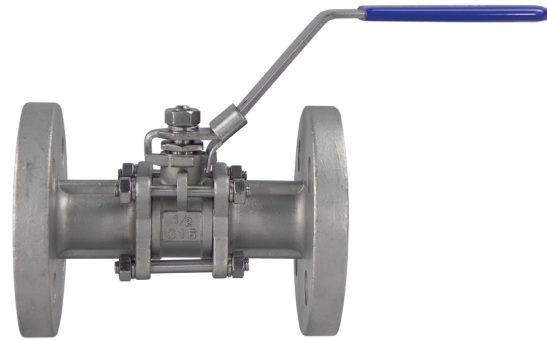
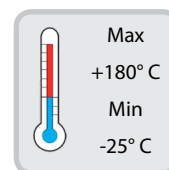

Estremità flangiate  
UNI EN 1092  
Flanged ends  
UNI EN 1092

## DIMENSIONI - DIMENSIONS (mm)

Size	d	L	D	D1	D2	b	f	H	W	Z	N/m
DN15	15	130	95	65	45	16	2	84	148	4xØ14	5
DN20	20	150	105	75	58	18	2	87	148	4xØ14	8
DN25	25	160	115	85	68	18	2	93	170	4xØ14	10
DN32	32	180	140	100	78	18	2	99	170	4xØ18	14
DN40	40	200	150	110	88	18	3	114	212	4xØ18	18
DN50	50	230	165	125	102	20	3	122	212	4xØ18	25
DN65	65	290	185	145	122	22	3	150	254	8xØ18	48
DN80	80	310	200	160	138	24	3	161	254	8xØ18	75
DN100	100	350	235	190	162	24	3	180	285	8xØ22	110

Size   
DN15-DN100 40 bar



ASTA ANTISCOPPIO  
ANTI BLOW-OUT STEM

