



IT



EN



DE



FR



RU



Catalogo
AH01

Listino Prezzi
Price List

Gentile Cliente,
siamo lieti di presentarle il nuovo Catalogo - Listino Prezzi relativo alla nostra gamma di prodotti. Per una migliore consultazione il catalogo è suddiviso in cinque parti in base al tipo di applicazione: riscaldamento, valvole motorizzate, acqua, gas, industria (identificate da diversi colori). L'ampia gamma di articoli permette una scelta sempre più mirata per ogni tipologia di applicazione.
IVR è lieta di augurarle buon lavoro!

Dear Customer,
we are glad to introduce our new Catalogue - Price List covering our whole product range. For a better understanding, we have divided the range into five different parts: heating, actuated valves, water, gas, industry (identified by different colors). Our comprehensive range of products allows a specific choice according to the type of application.
IVR wishes you a successful work!

Sehr geehrter Kunde,
wir freuen uns, Ihnen den Katalog - die Preisliste unserer Produktion vorstellen zu können. Für ein einfacheres Nachschlagen ist es in fünf Anwendungsarten aufgeteilt (Heizung, Servosteuerungen, Wasser, Gas, Industrie), die durch verschiedene Farben gekennzeichnet sind. Die große Artikelpalette ermöglicht eine immer gezieltere Wahl für alle Anlagentypen.
IVR wünscht Ihnen eine erfolgreiche Arbeit.

Cher Client,
nous sommes heureux de vous présenter notre nouveau Catalogue - Liste de prix couvrant notre complète gamme de produits. Pour une meilleure compréhension, nous avons divisé la gamme en cinq parties différentes: chauffage, vannes motorisées, eau, gaz, industrie (identifiés par des couleurs différentes). Notre gamme de produits permet un choix spécifique selon le type d'application.
IVR vous souhaite bon travail.

Уважаемые покупатели, мы рады представить вам Каталог - Прайс-лист нашей продукции.
Для наибольшего удобства он разделён на пять частей, которые различаются по цветовой гамме (оборудование для отопительных систем, приводы, запорная арматура для воды, газа и промышленная запорная арматура). Богатый ассортимент продукции позволяет осуществить оптимальный выбор для системы любого типа.
Компания IVR желает вам успехов в работе.





Mission

Diventare un punto di riferimento mondiale nella produzione di componenti per la gestione dei fluidi, acqua, gas, oil, etc., nella progettazione di sistemi, anche complessi, per il risparmio energetico, la gestione delle risorse termiche e il miglior confort possibile.

Vision

Innovazione, soddisfazione del cliente, internazionalizzazione attraverso una rete mondiale di distribuzione, collaborazione con industrie e università caratterizzano la ns. vision strategica.

Valori

La qualità riconosciuta nel tempo è il nostro valore più grande. Come azienda familiare prima e poi come realtà industriale, 65 anni di Storia, sono qui a dimostrare che il mestiere non si improvvisa.

Malgrado la nostra Storia ogni giorno siamo sul campo ad imparare e a trasmettere esperienza sui mercati di tutto il mondo. Semplicità, concretezza e voglia di progredire sono valori a cui ci ispiriamo e che vogliamo trasmettere.

Mission

Become a world reference in the production of components for water, gas, oil, etc. and in the design of systems for energy-saving, heat management, and best possible comfort.

Vision

Innovation, customer satisfaction, internationalization through a worldwide network of distributors and collaboration with industries and universities.

Values

The recognized quality over the time is our most important value. As a family business first and then as an industrial reality, 65 years of history are here to show that excellent manufacturing can't be extemporized.

Despite our history, every day we are on the field to learn and to pass on our experience to the markets around the world. Simplicity, concreteness and desire to progress are values to which we aspire and we want to convey.



Da destra: Flavio, Piero e Graziano Giacomini

**IVR:
UN'AZIENDA
IN CONTINUA
EVOLUZIONE**

Qualità, servizio ed innovazione: questi sono i valori di IVR. Azienda fondata nel 1973, ha saputo negli anni conquistare la fiducia dei professionisti più esigenti in oltre 60 Paesi al mondo dove è presente con numerose certificazioni. Conosciuta ed apprezzata internazionalmente come produttrice di valvole a sfera per acqua, gas e valvole per l'industria, dopo oltre 30 anni di attività ha voluto continuare il proprio percorso di innovazione.

Nel 2001 ha compiuto grandi investimenti per edificare un nuovo e moderno stabilimento dotato dei più sofisticati ed efficienti macchinari. Presso il laboratorio di Ricerca e Sviluppo IVR un team di tecnici, grazie alla decennale esperienza e sentite le esigenze emerse del settore commerciale, ha messo a punto nuove linee di prodotto tra le quali: valvole per riscaldamento, teste termostatiche, moduli di contabilizzazione e kit per la ripartizione dei costi di riscaldamento, sistemi di riscaldamento a pannelli radianti.

La ricerca e l'innovazione assumono una particolare importanza quando si tratta di ambiente. Grande attenzione viene infatti riservata all'ecologia privilegiando, in ogni fase del processo produttivo, l'impiego di materiali ecocompatibili e non inquinanti. I rapporti umani rappresentano il valore più importante dell'azienda; la forte motivazione che unisce le persone che operano in IVR è una chiave del successo dell'azienda.

**IVR:
A COMPANY
IN CONSTANT
EVOLUTION**

Quality, service and innovation: these are the principles of IVR. The company was founded in 1973, years of hard work and continuous improvement have allowed IVR to gain trust and a reputation of reliability amongst the leading operators of the valve business across over 60 countries worldwide. IVR products have obtained approvals from many certification bodies across the globe. Recognized globally as a top level ball valve producer for water, gas and industrial applications for 30 years, recently new steps in the constant evolution process are being taken.

In 2001 a brand new production plant has been built and investments in state of the art machinery have been made. The IVR R&D department, counting on its long and worthy experience, and following the requests from the marketing and sales, have planned and developed new ranges of products among which valves for heating systems, thermostatic valves, metering units and floor heating equipment.

Research and Development become extremely important when the environment is concerned. An environment friendly approach is present at all levels of the production process, great attention is used in the choice of eco-friendly materials. The human relationships are a main value for IVR; strongly motivated and team oriented people are what make IVR a successful company.



Il nostro Sistema Qualità Aziendale è certificato secondo UNI EN ISO 9001:2015

Our Quality System has been certified according to UNI EN ISO 9001:2015

Unser unternehmensinternes Qualitätssystem ist nach Norm UNI EN ISO 9001:2015 zertifiziert

Notre système de qualité d'entreprise est certifié selon UNI EN ISO 9001:2015

Система качества нашей продукции подтверждена сертификатом UNI EN ISO 9001:2015

I nostri prodotti sono omologati ed approvati dai principali Enti di Certificazione Internazionali

Our products have been approved by the following international standards

Unsere Produkte wurden von den wichtigsten internationalen Zertifizierungsstellen zugelassen und genehmigt

Nos produits sont certifiés et approuvés par les principaux Organismes de certification internationaux

Наша продукция проверена и одобрена ведущими сертификационными организациями





IVR 804/R

Collettore di mandata con misuratori di portata e rubinetto di carico/scarico acqua; collettore di ritorno con valvola termostattizzabili con cappello di regolazione e rubinetto di carico/scarico acqua

Inlet manifold with flow meters and fill & drain valve; outlet manifold with thermostatic valves with operating plastic cap and fill & drain valve

NEW

p.9



IVR 805/R

Collettore di mandata con detentori micrometrici e rubinetto di carico/scarico acqua; collettore di ritorno con valvole termostattizzabili con cappello di regolazione e rubinetto di carico/scarico acqua

Inlet manifold with micrometric lockshields and fill & drain valve; outlet manifold with thermostatic valves with operating plastic cap and fill & drain valve

NEW

p.10



IVR 877/R

Collettore di ritorno con valvole termostattizzabili con cappello di regolazione e con rubinetto di carico/scarico acqua

Outlet manifold with thermostatic valves with operating plastic cap and fill & drain valve

NEW

p.15



IVR 878/R

Collettore di mandata con misuratori i portata 0,5-5 lt/min e con rubinetto di carico/scarico acqua

Inlet manifold with flow meters 0.5-5 lt/min and fill & drain valve

NEW

p.16



IVR 879/R

Collettore di mandata con detentori micrometrici e con rubinetto di carico/scarico acqua

Inlet manifold with micrometric lockshields and fill & drain valve

NEW

p.18



IVR 714/R

Raccordo 3 pezzi postasonda per gruppi di miscela IVR 711

Three-piece sensor connection for mixing units IVR 711

NEW

p.32



IVR 205/A - 205/B

Valvola a sfera a passaggio totale con dado folle - attacchi M/F - sede piana

Full bore ball valve with crazy nut - M/F, with flat seat

NEW

p.34



IVR 463

Collettore in acciaio inox AISI 304 da 1"1/2 - 2", con attacchi M/M da 1/2", interasse 110 mm; adatto per contatore acqua con attacchi contrapposti

Stainless steel AISI 304 manifold 1"1/2 - 2" - connections M/M 1/2", center hole distance 110 mm; for water meter with parallel connections

NEW

p.45



IVR 836/I

Rubinetto orientabile di carico-scarico
Drain valve

NEW

p.54



IVR 836/IP

Rubinetto orientabile inclinato di carico-scarico in tecnopolimero

Rotating angle fill & drain valve in technopolymer

NEW

p.54



IVR 829/P

Misuratore di portata in tecnopolimero
Flow meter in technopolymer

NEW

p.57



IVR 563 CHR

THERMOCHROME, valvola termostattizzabile a squadra, attacco PEX, multistrato e tubo rame, bocchettone autotenuta, cromata

THERMOCHROME, chrome-plated angle thermostatic valve, PEX, multilayer and copper pipe connection, autoseal tail piece

NEW

p.65



IVR 557 CHR

THERMOCHROME, detentore a squadra, attacco PEX, multistrato e tubo rame, bocchettone autotenuta, cromato

THERMOCHROME, chrome-plated angle lockshield, PEX, multilayer and copper pipe connection, autoseal tail piece

NEW

p.66



IVR 561 CHR

THERMOCHROME, valvola termostattizzabile a squadra, fornita con adattatore per attacco tubo ferro, bocchettone autotenuta, cromata

THERMOCHROME, chrome-plated angle thermostatic valve, iron pipe connection, autoseal tail piece

NEW

p.67



NEW
p.67

IVR 553 CHR

THERMOCHROME, detentore a squadra, fornita con adattatore per attacco tubo ferro, bocchettone autotenuta, cromato

THERMOCHROME, chrome-plated angle lockshield, iron pipe connection, autoseal tail piece



NEW
p.81

IVR 566 KIT

Dritto, per attacco tubo ferro
Straight, iron pipe connection



NEW
p.81

IVR 567 KIT

A squadra, per attacco tubo ferro
Angle, iron pipe connection



NEW
p.81

IVR 568 KIT

Dritto, attacco tubo rame, PEX e multistrato
Straight, PEX, multilayer and copper pipe connection



NEW
p.81

IVR 569 KIT

A squadra, attacco tubo rame, PEX e multistrato
Angle, PEX, multilayer and copper pipe connection



NEW
p.82

IVR 570 KIT

A squadra, per attacco tubo ferro
Angle, iron pipe connection



NEW
p.82

IVR 571 KIT

A squadra, attacco tubo rame, PEX e multistrato
Angle, PEX, multilayer and copper pipe connection



NEW
p.92

IVR 505 - IVR 505/2

Mercury ECO, valvola manuale per radiatori, a squadra, attacco tubo ferro, bocchettone con autotenuta, nichelata

Mercury ECO, angle manual radiator valve, iron pipe connection, with auto-seal tail piece, nickel plated



NEW
p.92

IVR 506 - IVR 506/2

Mercury ECO, detentore per radiatori, a squadra, attacco tubo ferro, bocchettone con/senza autotenuta, nichelato

Mercury ECO, angle lockshield, iron pipe connection, with/without auto-seal tail piece, nickel plated



NEW
p.93

IVR 508 - IVR 508/2

Mercury ECO, valvola manuale per radiatori, a squadra, attacco tubo rame, bocchettone con autotenuta, nichelata

Mercury ECO, angle manual radiator valve, copper connection, with auto-seal tail piece, nickel plated



NEW
p.93

IVR 510 - IVR 510/2

Mercury ECO, detentore per radiatori, a squadra, attacco tubo rame, bocchettone con/senza autotenuta, nichelato

Mercury ECO, angle lockshield, copper connection, with/without auto-seal tail piece, nickel plated



NEW
p.99

IVR 748

Valvola fan-coil a 2 vie - attacchi M/M
Fan-coil 2-way valve - M/M



NEW
p.102

IVR 341

Valvola in bronzo ad orifizio variabile, filettata F/F ISO 228/1, brugola di presettaggio in dotazione. Condizioni di esercizio da -10° a +130°

Bronze valve with variable orifice, F/F ISO 228/1 threaded unions, supplied with Allen key for setting. Working temperatures: -10° +130°



NEW
p.103

IVR 344

Valvola di bilanciamento automatico in ottone DZR con bocchettoni filettata F/F ISO 7/1 RP condizioni di esercizio da -10° a +130°

Automatic balancing valve in DZR brass with tail piece F/F ISO 7/1 RP thread working temperatures -10° +130°



NEW
p.106

IVR 347

Valvola di sicurezza doppia funzione - temperatura e pressione attacchi filettati M/F
Double-use safety valve - temperature and pressure M/F



NEW
p.107

IVR 352/L

Valvola di sicurezza con leva per scaldabagni - tipo leggero
Safety valve for water heaters - light version



NEW
p.107

IVR 369

Valvola di sicurezza a squadra a tenuta metallica
Angle safety valve with metallic sealing



NEW
p.110

IVR 149 - IVR 150

Rubinetto porta manometro M/F con premistoppa e foro di spurgo, maniglia termoplastica
Manometer holder M/F with packing nut and drain hole, handle in thermoplastic



NEW
p.110

IVR 909

Defangatore magnetico completo di tappo, bocchettoni e rubinetto di scarico
Dirt separator with magnet, cap, fittings and drain cock with hose connection



NEW
p.140-141

IVR 45 LB - IVR 45/A FB

Valvola a sfera a passaggio totale - attacchi F/F, con maniglia blu
Full bore ball valve - threaded ends F/F, with blue handle



NEW
p.140-141

IVR 45 LN - IVR 45/A FN

Valvola a sfera a passaggio totale - attacchi F/F, con farfalla nera
Full bore ball valve - threaded ends F/F, with black butterfly handle



NEW
p.150-151

IVR 954 LB - IVR 954/A FB

Valvola a sfera a passaggio totale - attacchi F/F, con maniglia blu
Full bore ball valve - threaded ends F/F, with blue handle



NEW
p.150-151

IVR 954 LN - IVR 954/A FN

Valvola a sfera a passaggio totale - attacchi F/F, con maniglia nera
Full bore ball valve - threaded ends F/F, with black handle



NEW
p.156

IVR 954/P

Valvola a sfera a passaggio totale - attacchi FF - con porlunga per coibentazione
Full bore ball valve - threaded ends F/F, with red handle - with isolation extension



NEW
p.158

IVR 935 PLUS

Valvola a sfera a passaggio standard - attacchi filettati F/F, con leva in alluminio nera
Standard bore ball valve - threaded ends F/F, with black handle in aluminium



NEW
p.159-160

IVR 935 LB - IVR 935/A FB

Valvola a sfera a passaggio standard - attacchi F/F, con maniglia blu
Standard bore ball valve - threaded ends F/F, with blue handle



NEW
p.159-160

IVR 935 LN - IVR 935/A FN

Valvola a sfera a passaggio standard - attacchi filettati F/F, con maniglia nera
Standard bore ball valve - F/F thread ends, with black handle



NEW
p.164-165

IVR 918 LB - IVR 918/A FB

Valvola a sfera a passaggio standard - attacchi F/F, con maniglia blu
Standard bore ball valve - threaded ends F/F, with blue handle



NEW
p.140-141

IVR 918 LN - IVR 918/A FN

Valvola a sfera a passaggio standard -
attacchi F/F, con maniglia nera

Standard bore ball valve - threaded ends
F/F, with black handle



NEW
p.179

IVR 759

Valvola miscelatrice termostatica a 3 vie per
impianti solari - attacchi F/F/F

3-way thermostatic mixing valve for solar
systems - F/F/F



NEW
p.181-207

IVR 607 NPT

Saracinesca PN16 - volantino in acciaio -
attacchi F/F NPT

Gate valve PN16 - handle in steel - F/F NPT



NEW
p.188

IVR 944/2 AS

Con bocchettone. Sede conica M/F

With tailpiece. Conical seat M/F



NEW
p.192

IVR 72 - IVR 73

Valvola a sfera a tre vie deviatrice a
passaggio ridotto sfera forata a T - attacchi
F/F/F

3-way diverter ball valve with reduced bore -
type T - F/F/F



NEW
p.195

IVR 392

Valvola a sfera in ottone con maniglia a T,
attacchi F/F

Ball valve in brass with T handle, F/F



NEW
p.203

IVR 90

Valvola di fondo tubolare

Cylindrical foot valve



NEW
p.210

IVR 398 - IVR 399

Filtro autopulente F/F

Self-cleaning filter F/F



NEW
p.212

IVR 310 P/N

Raccordo diritto in tre pezzi a sede piana con
guarnizione, nichelato

Nickel-plated 3-piece straight union end with
flat seat with gasket

CODE	PAG.
20	182
20/A	182
25	184
25/A	184
42	189
42/43 R	215
43	189
45	140
45 GAS	227
45 LB	NEW 140
45 LD	146
45 LD GAS	227
45 LN	NEW 140
45 NPT	181
45 PLUS	139
45/A	141
45/A FB	NEW 141
45/A FN	NEW 141
45/A GAS	227
45/A NPT	181
46	142
46 LB	NEW 142
46 LD	146
46 LN	NEW 142
46 PLUS	139
46/A	143
46/A FB	NEW 143
46/A FN	NEW 143
47	144
47 LB	NEW 144
47 LN	NEW 144
47 PLUS	139
47/A	145
47/A FB	145
47/A FN	145
48 TOP	137
48/A TOP	137
49 TOP	137
49/A TOP	137
52	147
52/A	147
58	171
58/A	171
60/A	187
60/B	187
62	109
63	192
64	109
68	186
68/A	186
69	186
69/A	187
70	191
71	191
72	NEW 192
73	NEW 192
77	247

CODE	PAG.
77 + 180	247
77 + 270	272
77 + 271	277
77 + 272 M	254
77 + 272 T	259
78	247
78 + 180	248
78 + 270	272
78 + 271	277
78 + 272 M	254
78 + 272 T	259
80	249
81	249
82	236
82 + 180	236
83	237
83 + 180	237
86/A	46
86/B	46
90	NEW 203
98	203
100	221
100 DIN	219
100 GW 4MS	172
100 GW 4MS KIWA	175
100 LD	222
100/A	221
100/A DIN	219
100/A GW 4MS	172
101	221
101 GW 4MS	172
101 GW 4MS KIWA	176
101 LD	222
101/A	222
101/A GW 4MS	173
103	108 -199
105	108 - 199
108	193
109	193
110	231
111	232
112	232
113	233
114	233
116	233
117	233
118	232
120 GW 4MS	174
121 GW 4MS	175
129	198
130	201
130 R	215
134	201
135	201
136	200
136A	200
137	190

CODE	PAG.
137 GW 4MS	174
137 R	190
140	206
144 L	244
144 L + 270	271
144L + 218	264
144L + 271	275
144L + 272 M	257
144L + 272 T	262
145 T + 272 T	263
145 T	244
145 T + 270	271
145T + 218	264
145T + 271	276
145T + 272 M	258
149	NEW 110
150	NEW 110
151	229
151/A	229
152	229
152/A	230
157 GW 4MS	174
161	234
162	234
170	250
172	250
172 C	253
172 G	253
174	252
175	251
175 + 270	273
175 + 271	278
175 + 272 M	255
175 + 272 T	260
176	251
176 + 270	273
176 + 271	278
176 + 272 M	255
176 + 272 T	260
177	238
178	238
182	223
183	223
190	224
190/A	224
191	225
191/A	225
192	223
193	234
194	234
200	185
205/A	NEW 34
205/B	NEW 34
206/A	34
206/B	34
208 GW 4MS	173
208 GW 4MS KIWA	176

CODE	PAG.
208/A GW 4MS	173
210	184
212	231
212/A	231
215 B	123
215 DIV EASY	132
215 MIX EASY	131
215 UB	123
215 B	123
215/D	123
217 3P	124
218 3P	267
218 DIV	130
218 MIX	128
218 UNI DIV	130
218 UNI MIX	128
220	118
220 + 215	114
221	119
221 + 215	114
222	119
222 + 215	115
223	119
223 + 215	115
230	118
230 + 217	114
235	120
235 + 215	115
236	120
236 + 215	116
237	121
237 + 215	116
238	121
238 + 215	116
240	121
240 + 215	117
241	122
241 + 215	117
242	122
242 + 215	117
243	122
243 + 215	118
245 + 215 MIX EASY	131
245 MIX EASY	131
246	127
246 + 218 MIX	126
247	127
247+ 218 MIX	126
248	129
248 + 218 DIV	129
249 + 215 DIV EASY	132
249 DIV EASY	132
270	279
271	279
272 M	266
272 T	266
273	235

CODE	PAG.
274	235
276 CF8 M + 272 M	255
276 CF8M	251
276 CF8M + 270	273
276 CF8M + 271	278
276CF8M + 272 T	260
277 CF8M	238
278 CF8M	239
297	200
300	209
302	208
303	209
304	208
305	208
306	209
310 C	213
310 C/N	NEW 213
310 P	211
310 P/N	NEW 212
311	56
312 P	211
312 P/N	NEW 211
315 C	213
315 C/N	NEW 214
315 P	212
315 P/N	NEW 212
316	56
318	NEW 214
320	214
321	214
324	84 - 94
325	84 - 94
326	84 - 94
330	32
330/C	32
331	33
332	33
334	101
336	101
340	102
341	NEW 102
342	102 - 250
344	NEW 103
344/C	NEW 103
346	104
347	NEW 106
350	105
351	NEW 106
352	NEW 107
352/L	NEW 107
353	NEW 107
353/L	NEW 108
354	NEW 106
355	105
356	105
358	101 - 216
359	216

CODE	PAG.
360	52
361	52
364	53
367	53
369	NEW 107
380	193
381	194
382	194
392	NEW 195
393	NEW 195
395 C	NEW 194
395	NEW 195
396	NEW 195
398	NEW 210
399	NEW 210
404	40
405	55
406	47
407	56
408	55
408 K	40
411	55
412	56
414	57
415	57
416	47
417	47
435	96
436	82
437	96
438	96
440	178
440/A	178
441	178
441/A	179
442	179
443	179
457	84
458	83
459	83
462	45
463	NEW 45
471	63
472	61
473	59
481	62
482	60
483	58
505	NEW 92
505/2	NEW 92
506	NEW 92
506/2	NEW 92
508	NEW 93
508/2	NEW 93
509/A	30
509/B	30
510	NEW 93

CODE	PAG.
510/2	NEW 93
511	29
512	28
513	27
514	26
515	25
516	24
521	23
523	22
525	21
530	79
530 AD	79
530/2	79
534	86
534/2	86
535	87
535/2	87
536	86
536/2	86
537	87
537/2	87
538	90
538/2	90
539	91
539/2	91
540	90
540/2	90
541	91
541/2	91
546	88
546/2	88
547	89
547/2	89
548	88
548/2	88
549	89
549/2	89
551	74
551 CHR	NEW 68
551/2	74
551/C	46
553	74
553 CHR	NEW 67
553/2	74
555	80
555 CHR	NEW 66
555/2	80
557	80
557 CHR	NEW 66
557/2	80
560	72
560 CHR	NEW 68
560/2	72
560/3	73
560/4	73
561	70
561 CHR	NEW 67

CODE	PAG.
561/2	70
561/3	70
561/4	70
562	77
562 CHR	NEW 66
562/2	77
562/3	77
562/4	77
563	75
563 CHR	NEW 65
563/2	75
563/3	75
563/4	75
566	73
566 KIT	81
566/2	73
566/3	73
566/4	73
566/C	46
567	71
567 KIT	NEW 81
567/2	71
567/3	71
567/4	71
568	78
568 KIT	NEW 81
568/2	78
568/3	78
568/4	78
569	76
569 KIT	NEW 81
569/2	76
569/3	76
569/4	76
570	72
570 KIT	NEW 82
570/2	72
570/3	NEW 72
570/4	NEW 72
571	76
571 KIT	NEW 82
571/2	76
571/3	NEW 77
571/4	NEW 77
580	50 - 100
580 CHR	68
581	50 - 100
581 CHR	68
586	95
587	95
588	85
590	95
591	33 - 69
594	85
595	85
596	85
597	69

CODE	PAG.
597 CHR	65
599	69
600	206
605	206
607 NPT	NEW 181 - 207
620	207
650	194 - 207
653	252
654	246
655	245
656	245
657	246
660	243
665	243
665 + 218	264
665 + 270	270
665 + 271	274
665 + 272 M	256
665 + 272 T	261
670	243
670 + 218	264
670 + 270	270
670 + 271	274
670 + 272 M	256
670 + 272 T	261
672	244
672 + 218	264
672 + 270	271
672 + 271	275
672 + 272 M	257
672 + 272 T	262
685	245
685 + 218	265
685 + 270	272
685 + 271	276
685 + 272 M	258
685 + 272 T	263
687	246
696	253
697	252
711	31
712	31
713	31
714	32
714/R	NEW 32
718	104
718/C	104
748	NEW 99
749	NEW 99
750	NEW 99
753	97
754	97
755	97
756	98
758	98
759	NEW 179
760	NEW 180

CODE	PAG.
773 CHR	67
774 CHR	67
776 CHR	66
777 CHR	65
795	280
796	280
797	280
798 F	281
798 S	281
800	7
801	7
802	8
802 KIT A	5
803	8
803 KIT A	6
804	9
804/R	NEW 9
805	10
805/R	NEW 10
806	11
807	11
809/A	188
809/B	188
813	12
814	12
814 KIT A	6
816	52
820	36
821	39
822	40
823	38
824	38
825	39
827/A	35
827/B	35
829	57
829/P	NEW 57
830	51
831	51
832	52
833	53
836	54
836/I	NEW 54
836/IP	NEW 54
837	53
838	54
840	39
844	47
847 A	41
847 C	41
847 I	47
858	49
867	20
868	19
869	19
871	18
872	48

CODE	PAG.
873	48
874	48
875	13
875 CS	13
877	14
877 CS	14
877/R	NEW 15
878	16
878 CS	15
878/R	NEW 16
879	17
879 CS	17
879/R	NEW 18
882	42
883	43
884	43
893	44
896	56
897	41
904	108 - 199
905	109 -199
909	110
918	164
918 LB	NEW 164
918 LN	NEW 164
918/A	165
918/A FB	NEW 165
918/A FN	NEW 165
919	166
919 LB	NEW 166
919 LN	NEW 166
919/A	167
919/A FB	NEW 167
919/A FN	NEW 167
920	168
920 LB	NEW 168
920 LN	NEW 168
920/A	169
920/A FB	NEW 169
920/A FN	NEW 169
923	204
924	205
924 C	216
925	197
926	197
927	197
928	198
935	159
935 LB	NEW 159
935 LN	NEW 159
935 PLUS	NEW 158
935/A	160
935/A FB	NEW 160
935/A FN	NEW 160
936	161
936 LB	NEW 161
936 LN	NEW 161

CODE	PAG.
936 PLUS	NEW 158
936/A	162
936/A FB	NEW 162
936/A FN	NEW 162
944/2 AS	NEW 188
944/AS	37
954	150
954 LB	NEW 150
954 LD	156
954 LN	NEW 150
954 PLUS	149
954 S	37 - 188
954/A	151
954/A FB	NEW 151
954/A FN	NEW 151
954/P	NEW 156
956	152
956 LB	NEW 152
956 LN	NEW 152
956 PLUS	149
956/A	153
956/A FB	NEW 153
956/A FN	NEW 153
957	154
957 LB	NEW 154
957 LN	NEW 154
957 PLUS	149
957/A	155
957/A FB	NEW 155
957/A FN	NEW 155
961/A	187
961/B	187
966	196
966 R	215
966/A	196
979/A	36
979/B	36
980/A	35
980/B	35
981/A	35
981/B	35
982/A	34
982/B	34
990	133
993 TG	202
993 TM	202
994	202
995 L	203
999 H	204
999 L	204



RISCALDAMENTO

HEATING

HEIZUNG

CHAUFFAGE

ОТОПЛЕНИЕ



SERVOCOMANDI E VALVOLE MOTORIZZABILI

ACTUATORS AND MOTORIZED VALVES

SERVOSTEUERUNGEN UND MOTORISIERBARE KUGELHÄHNE

SERVOCOMMANDES ET VANNES MOTORISABLES

СЕРВОПРИВОДЫ И КЛАПАНЫ



VALVOLE ACQUA

WATER VALVES

KUGELHÄHNE FÜR WASSER

VANNES EAU

КЛАПАНЫ ДЛЯ ВОДЫ



VALVOLE GAS

GAS VALVES

GASKUGELHÄHNE

VANNES GAZ

КЛАПАНЫ ДЛЯ ГАЗА



VALVOLE INDUSTRIA

INDUSTRIAL VALVES

INDUSTRIEKUGELHÄHNE - VENTILE UND ARMATUREN

VANNES INDUSTRIE

ИНДУСТРИАЛЬНАЯ ЗАПОРНАЯ АРМАТУРА



RISCALDAMENTO
HEATING
HEIZUNG
CHAUFFAGE
ОБОРУДОВАНИЕ ДЛЯ СИСТЕМ ОТОПЛЕНИЯ





Collettori Manifolds

Collettori Inox - AvantFloor / Inox Manifolds - AvantFloor	p. 5
Multiklima distribuzione / Multiklima distribution	p. 21
Gruppi di miscelazione / Mixing units	p. 31
Collettori Inox - AvantFloor - Accessori / Inox Manifolds AvantFloor - Accessories	p. 34
Collettori Industriali - IVR Inox / Industrial Manifolds - IVR Inox	p. 42
Collettori Industriali - IVR Inox - Accessori / Industrial Manifolds - IVR Inox - Accessories	p. 46
Collettori in Ottone - SunnyFloor / Brass Manifolds - SunnyFloor	p. 48



IVR Multiklima

Multiklima contabilizzazione / Multiklima energy metering	p. 58
---	-------



Valvole per radiatori Radiator valves

Valvole Termostatiche / Thermostatic Valves	p. 65
Kit termostatici - Thermostatic kits	p. 81
Valvole Manuali / Manual Valves	p. 86
Valvole ad "H" / "H" valves	p. 97
Valvole Fan-coil / Fan-coil valves	p. 99
Adattatori / Adapters	p. 100



Componenti centrale termica Components for Central Heating System

Gruppo Alimentazione / Automatic filling unit	p. 101
Valvole di bilanciamento / Balancing valves	p. 102
Gruppi valvole di Sicurezza e scarico caldaia / Safety Valves	p. 104
Rubinetti scarico caldaia / Boiler bloww-off valves	p. 108

COLLETTORI / MANIFOLDS
Collettori Inox / Inox Manifolds
AVANT FLOOR



Collettore in acciaio inox AISI 304 1" - 1"1/4; Connessioni 3/4" EK - Zanche di fissaggio antivibrazione - Interasse 50 mm - Etichette e istruzioni
AISI 304 stainless steel manifold 1" - 1"1/4; 3/4" Eurocone connections - Mounting brackets which minimise noise and vibration - Centre hole distance 50 mm - Stickers and assembly instruction

Verteiler aus rostfreiem Edelstahl AISI 304 mit 1" - 1" 1/4; 3/4" Anschlüssen Eurokonus, schwingungsdämpfenden Befestigungs-Klammern, Abstand 50 mm - Etiketten und Anweisungen

Collecteur en acier inox AISI 304 1" - 1"1/4; fixations 3/4" EK. Plaques d'ancrage antivibration Entraxes 50 mm Étiquettes et instructions
Коллектор из нержавеющей стали AISI 304, размеры 1" - 1"1/4; 3/4", соединения Евроконус, межосевое расстояние 50 мм, крепления с защитой от вибрации, инструкция по сборке

KIT A 802 IVR

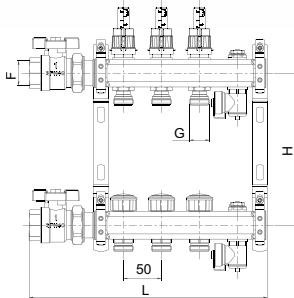

Collettore di mandata con misuratori di portata, valvola sfogo aria, rubinetto di carico/scarico acqua e valvola a sfera. Collettore di ritorno con valvole termostattizzabili, cappellotti di regolazione, valvola sfogo aria, rubinetto di carico/scarico acqua e valvola a sfera, tappi inclusi, con zanche di fissaggio

Inlet manifold with flow meters, air vent, fill & drain valve and ball valve. Return manifold with thermostatic valves, operating plastic caps, air vent, fill & drain valve and ball valve, plugs included, with mounting brackets

Vorlaufverteiler mit Durchflussmessern, Luftablassventil und Ein-/Ablassventil, Ein-/Ablassventil und Kugelhahn. Rücklaufverteiler mit thermostatisierbaren Ventilen, Einstellkappen, Luftablassventil und Ein-/Ablassventil und Kugelhahn - Stopfen inklusive, mit Befestigungsklammern

Collecteur d'alimentation avec mesureurs de débit, vanne de purge de l'air, robinet de chargement/déchargement et vanne à boisseau sphérique. Collecteur de retour avec vannes thermostatizables, chapeaux de réglage, vanne de purge de l'air, robinet de chargement/déchargement et vanne à boisseau sphérique, bouchons et plaques d'ancrage inclus

Входной коллектор с расходомерами, воздухоотводчиком, краном впуск-выпуск, шаровым краном. Обратный коллектор с термостатическими клапанами и регулируемыми колпачками, воздухоотводчиком, краном впуск-выпуск, шаровым краном. Комплектуется с заглушками для коллектора и кронштейнами.

Cod./Code	(F) Misura/Size	(G) Attacco/Connection	Vie/Ways	L(mm)	H(mm)	□/田	€
1802A22502	1"	3/4" EK	2	263	200	1	131,76
1802A22503	1"	3/4" EK	3	313	200	1	156,06
1802A22504	1"	3/4" EK	4	363	200	1	180,58
1802A22505	1"	3/4" EK	5	413	200	1	204,63
1802A22506	1"	3/4" EK	6	463	200	1	228,69
1802A22507	1"	3/4" EK	7	513	200	1	253,21
1802A22508	1"	3/4" EK	8	563	200	1	277,60
1802A22509	1"	3/4" EK	9	613	200	1	298,75
1802A22510	1"	3/4" EK	10	663	200	1	323,85
1802A22511	1"	3/4" EK	11	713	200	1	347,67
1802A22512	1"	3/4" EK	12	763	200	1	371,41
1802A32506	1"1/4	3/4" EK	6	486	200	1	285,42
1802A32507	1"1/4	3/4" EK	7	536	200	1	312,08
1802A32508	1"1/4	3/4" EK	8	586	200	1	338,35
1802A32509	1"1/4	3/4" EK	9	636	200	1	365,55
1802A32510	1"1/4	3/4" EK	10	686	200	1	392,21
1802A32511	1"1/4	3/4" EK	11	736	200	1	418,41
1802A32512	1"1/4	3/4" EK	12	786	200	1	444,69

KIT A 803 IVR

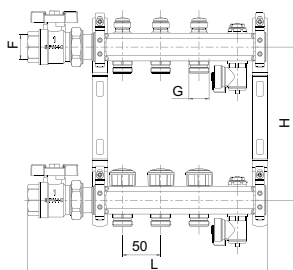

Collettore di mandata con detentori micrometrici, valvola sfogo aria, rubinetto di carico/scarico acqua, valvola a sfera. Collettore di ritorno con valvole termostattizzabili, cappellotti di regolazione, valvola sfogo aria, rubinetto di carico/scarico acqua e valvola a sfera, tappi inclusi, con zanche di fissaggio

Inlet manifold with micrometric lockshields, air vent and fill & drain valve, ball valve. Return manifold with thermostatic valves, operating plastic caps, air vent and fill & drain valve and ball valve, plugs included, with mounting brackets

Vorlaufverteiler mit mikrometrischen Rücklaufverschraubungen, Luftablassventil, Ein-/Ablassventil und Kugelhahn. Rücklaufverteiler mit thermostatisierbaren Ventilen, Einstellkappen, Luftablassventil, Ein-/Ablassventil und Kugelhahn - Stopfen inklusive, mit Befestigungsklammern

Collecteur d'alimentation avec détenteurs micrométriques, vanne de purge de l'air, robinet de chargement/déchargement, vanne à boisseau sphérique. Collecteur de retour avec vanne thermostatisables, chapeaux de réglage, vanne de purge de l'air, robinet de chargement/déchargement et vanne à boisseau sphérique, bouchons et plaques d'ancrage inclus

Входной коллектор с микрометрическими отсекающими вентилями, воздухоотводчиком, краном впуск-выпуск и шаровым краном. Обратный коллектор с термостатическими клапанами и регулируемыми колпачками, воздухоотводчиком, краном впуск-выпуск, шаровым краном и заглушками. В комплекте с кронштейнами.

Cod./Code	(F) Misura/Size	(G) Attacco/Connection	Vie/Ways	L(mm)	H(mm)	□/田	€
1803A22502	1"	3/4" EK	2	263	200	1	120,68
1803A22503	1"	3/4" EK	3	313	200	1	139,67
1803A22504	1"	3/4" EK	4	363	200	1	158,42
1803A22505	1"	3/4" EK	5	413	200	1	177,16
1803A22506	1"	3/4" EK	6	463	200	1	195,91
1803A22507	1"	3/4" EK	7	513	200	1	215,00
1803A22508	1"	3/4" EK	8	563	200	1	233,74
1803A22509	1"	3/4" EK	9	613	200	1	249,58
1803A22510	1"	3/4" EK	10	663	200	1	268,91
1803A22511	1"	3/4" EK	11	713	200	1	287,42
1803A22512	1"	3/4" EK	12	763	200	1	305,85
1803A32506	1"1/4	3/4" EK	6	486	200	1	248,78
1803A32507	1"1/4	3/4" EK	7	536	200	1	269,04
1803A32508	1"1/4	3/4" EK	8	586	200	1	289,36
1803A32509	1"1/4	3/4" EK	9	636	200	1	310,60
1803A32510	1"1/4	3/4" EK	10	686	200	1	330,85
1803A32511	1"1/4	3/4" EK	11	736	200	1	351,10
1803A32512	1"1/4	3/4" EK	12	786	200	1	371,35

KIT A 814 IVR

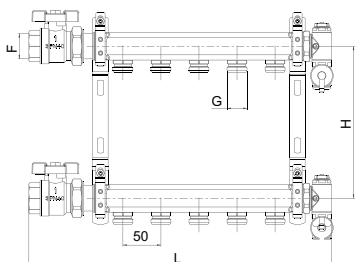

Collettore di mandata con valvola sfogo aria, rubinetto di carico/scarico acqua e valvola a sfera. Collettore di ritorno con valvola sfogo aria, rubinetto di carico/scarico acqua e valvola a sfera, tappi inclusi, con zanche di fissaggio

Inlet manifold with air vent, fill & drain valve and ball valve. Return manifold with air vent, fill & drain valve and ball valve, plugs included, with mounting brackets

Vorlaufverteiler mit Luftablassventil, Ein-/Ablassventil und Kugelhahn. Rücklaufverteiler mit Luftablassventil, Ein-/Ablassventil und Kugelhahn - Stopfen inklusive, mit Befestigungsklammern

Collecteur d'alimentation avec vanne de purge de l'air, robinet de chargement/déchargement et vanne à boisseau sphérique. Collecteur de retour avec vanne de purge de l'air, robinet de chargement/déchargement et vanne à boisseau sphérique, bouchons et plaques d'ancrage inclus

Входной коллектор с воздухоотводчиком, краном впуск-выпуск и шаровым краном. Обратный коллектор с воздухоотводчиком, краном впуск-выпуск, шаровым краном. Комплектуется с заглушками для коллектора и кронштейнами.

Cod./Code	(F) Misura/Size	(G) Attacco/Connection	Vie/Ways	L(mm)	H(mm)	□/田	€
1814A22502	1"	3/4" EK	2	248	200	1	109,25
1814A22503	1"	3/4" EK	3	298	200	1	121,29
1814A22504	1"	3/4" EK	4	348	200	1	133,82
1814A22505	1"	3/4" EK	5	398	200	1	146,11
1814A22506	1"	3/4" EK	6	448	200	1	158,39
1814A22507	1"	3/4" EK	7	498	200	1	171,02
1814A22508	1"	3/4" EK	8	548	200	1	183,31
1814A22509	1"	3/4" EK	9	598	200	1	195,60
1814A22510	1"	3/4" EK	10	648	200	1	208,79
1814A22511	1"	3/4" EK	11	698	200	1	221,08
1814A22512	1"	3/4" EK	12	748	200	1	233,44
1814A32506	1"1/4	3/4" EK	6	798	200	1	209,69
1814A32507	1"1/4	3/4" EK	7	848	200	1	222,92
1814A32508	1"1/4	3/4" EK	8	898	200	1	236,07
1814A32509	1"1/4	3/4" EK	9	948	200	1	250,21
1814A32510	1"1/4	3/4" EK	10	998	200	1	263,44
1814A32511	1"1/4	3/4" EK	11	1048	200	1	276,59
1814A32512	1"1/4	3/4" EK	12	1098	200	1	289,74

IVR 800

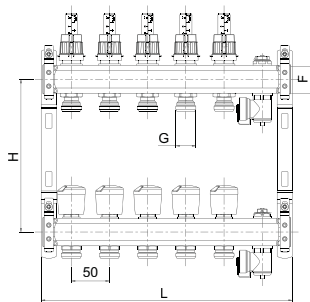

Collettore di mandata con misuratori di portata, valvola sfogo aria e rubinetto di carico/scarico acqua. Collettore di ritorno con valvole manuali con volantino, valvola sfogo aria e rubinetto di carico/scarico acqua, tappi e zanche di fissaggio incluse

Inlet manifold with flow meters, air vent and fill & drain valve. Return manifold with manual valves with handles, air vent and fill & drain valve, plugs and mounting brackets

Vorlaufverteiler mit Durchflussmessern, Entlüftungsventil und Füll - und Entleerungshahn. Rücklaufverteiler mit Ventilen mit Handrädern, Luftablassventil und Ein-/Ablassventil, komplett mit Kappen, mit Befestigungsklammern

Collecteur d'alimentation avec mesureurs de débits, vanne de purge de l'air et robinets de chargement/déchargement. Collecteur de retour avec vannes manuelles avec volant, vanne de purge de l'air et robinet de chargement/déchargement, bouchons et plaques d'ancrage inclus

Входной коллектор с расходомерами, воздухоотводчиком и краном впуск-выпуск. Обратный коллектор с ручными регулируемыми клапанами, воздухоотводчиком, краном впуск-выпуск и заглушками. В комплекте с кронштейнами.

Cod./Code	(F) Misura/Size	(G) Attacco/Connection	Vie/Ways	L(mm)	H(mm)	□/田	€
180022502	1"	3/4" EK	2	180	200	1	91,97
180022503	1"	3/4" EK	3	230	200	1	116,60
180022504	1"	3/4" EK	4	280	200	1	142,17
180022505	1"	3/4" EK	5	330	200	1	166,80
180022506	1"	3/4" EK	6	380	200	1	191,67
180022507	1"	3/4" EK	7	430	200	1	217,25
180022508	1"	3/4" EK	8	480	200	1	241,88
180022509	1"	3/4" EK	9	530	200	1	263,59
180022510	1"	3/4" EK	10	580	200	1	289,19
180022511	1"	3/4" EK	11	630	200	1	313,58
180022512	1"	3/4" EK	12	680	200	1	337,89
180032506	1"1/4	3/4" EK	6	380	200	1	213,71
180032507	1"1/4	3/4" EK	7	430	200	1	241,43
180032508	1"1/4	3/4" EK	8	480	200	1	268,28
180032509	1"1/4	3/4" EK	9	530	200	1	295,13
180032510	1"1/4	3/4" EK	10	580	200	1	323,19
180032511	1"1/4	3/4" EK	11	630	200	1	349,97
180032512	1"1/4	3/4" EK	12	680	200	1	376,82

IVR 801

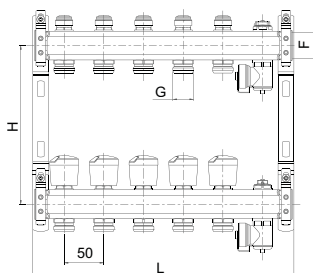

Collettore di mandata con detentori micrometrici, valvola sfogo aria e rubinetto di carico/scarico acqua. Collettore di ritorno con valvole manuali con volantino, valvola sfogo aria e rubinetto di carico/scarico acqua, tappi e zanche di fissaggio incluse

Inlet manifold with micrometric lockshields, air vent and fill & drain valve. Return manifold with manual valves with handles, air vent and fill & drain valve, plugs and mounting brackets

Vorlaufverteiler mit mikrometrischen Rücklaufverschraubungen, Luftablassventil und Ein-/Ablassventil. Rücklaufverteiler mit Ventilen mit Handrädern, Luftablassventil und Ein-/Ablassventil, komplett mit Kappen und Befestigungsklammern

Collecteur d'alimentation avec coude de réglage micrométriques, vanne de purge de l'air et robinet de chargement/déchargement. Collecteur de retour avec vannes manuelles, vanne de purge de l'air et robinet de chargement/déchargement, bouchons et plaques d'ancrage inclus

Входной коллектор с микрометрическими отсекающими вентилями, воздухоотводчиком и краном впуск-выпуск. Обратный коллектор с ручными регулируемыми клапанами, воздухоотводчиком, краном впуск-выпуск и заглушками. В комплекте с кронштейнами.

Cod./Code	(F) Misura/Size	(G) Attacco/Connection	Vie/Ways	L(mm)	H(mm)	□/田	€
180122502	1"	3/4" EK	2	180	200	1	80,89
180122503	1"	3/4" EK	3	230	200	1	100,21
180122504	1"	3/4" EK	4	280	200	1	120,01
180122505	1"	3/4" EK	5	330	200	1	139,33
180122506	1"	3/4" EK	6	380	200	1	158,89
180122507	1"	3/4" EK	7	430	200	1	178,70
180122508	1"	3/4" EK	8	480	200	1	198,01
180122509	1"	3/4" EK	9	530	200	1	214,42
180122510	1"	3/4" EK	10	580	200	1	234,25
180122511	1"	3/4" EK	11	630	200	1	253,33
180122512	1"	3/4" EK	12	680	200	1	272,33
180132506	1"1/4	3/4" EK	6	380	200	1	177,08
180132507	1"1/4	3/4" EK	7	430	200	1	198,39
180132508	1"1/4	3/4" EK	8	480	200	1	219,28
180132509	1"1/4	3/4" EK	9	530	200	1	240,18
180132510	1"1/4	3/4" EK	10	580	200	1	261,83
180132511	1"1/4	3/4" EK	11	630	200	1	282,65
180132512	1"1/4	3/4" EK	12	680	200	1	303,55

IVR 802

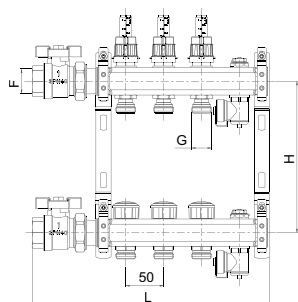

Collettore di mandata con misuratori di portata, valvola di sfogo aria e rubinetto di scarico/carico acqua. Collettore di ritorno con valvole termostattizzabili con cappellotti di regolazione, valvola sfogo aria e rubinetto di carico/scarico, tappi e zanche di fissaggio incluse

Inlet manifold with flow meters, air vent and fill & drain valve. Return manifold with thermostatic valves with operating plastic caps, air vent and fill & drain valve, plugs and mounting brackets

Vorlaufverteiler mit Durchflussmessern, Luftablassventil und Ein-/Ablassventil. Rücklaufverteiler mit thermostatisierbaren Ventilen mit Einstellkappen, Luftablassventil und Ein-/Ablassventil, komplett mit Kappen und Befestigungsklammern

Collecteur d'alimentation avec mesureurs de débit, vanne de purge de l'air et robinet de chargement/déchargement. Collecteur de retour avec vannes thermostatisables avec chapeaux de réglage, vanne de purge de l'air et robinet de chargement/déchargement, bouchons et plaques d'ancrage inclus

Входной коллектор с расходомерами, воздухоотводчиком и краном впуск-выпуск. Обратный коллектор с термостатическими клапанами и регулирующими колпачками, воздухоотводчиком, краном впуск-выпуск и заглушками. В комплекте с кронштейнами.

Cod./Code	(F) Misura/Size	(G) Attacco/Connection	Vie/Ways	L(mm)	H(mm)	□/田	€
180222502	1"	3/4" EK	2	180	200	1	90,35
180222503	1"	3/4" EK	3	230	200	1	114,40
180222504	1"	3/4" EK	4	280	200	1	138,92
180222505	1"	3/4" EK	5	330	200	1	162,98
180222506	1"	3/4" EK	6	380	200	1	187,28
180222507	1"	3/4" EK	7	430	200	1	211,80
180222508	1"	3/4" EK	8	480	200	1	235,85
180222509	1"	3/4" EK	9	530	200	1	257,00
180222510	1"	3/4" EK	10	580	200	1	281,54
180222511	1"	3/4" EK	11	630	200	1	305,36
180222512	1"	3/4" EK	12	680	200	1	329,10
180232506	1"1/4	3/4" EK	6	380	200	1	209,31
180232507	1"1/4	3/4" EK	7	430	200	1	235,98
180232508	1"1/4	3/4" EK	8	480	200	1	262,26
180232509	1"1/4	3/4" EK	9	530	200	1	288,54
180232510	1"1/4	3/4" EK	10	580	200	1	315,54
180232511	1"1/4	3/4" EK	11	630	200	1	341,74
180232512	1"1/4	3/4" EK	12	680	200	1	368,02

IVR 803

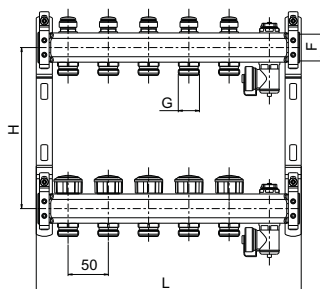

Collettore di mandata con detentori micrometrici, valvola sfogo aria e rubinetto di carico/scarico acqua. Collettore di ritorno con valvole termostattizzabili con cappellotti di regolazione, valvola sfogo aria e rubinetto di carico/scarico acqua, tappi e zanche di fissaggio incluse

Inlet manifold with micrometric lockshields, air vent and fill & drain valve. Return manifold with thermostatic valves with operating plastic caps, air vent and fill & drain valve, plugs and mounting brackets included

Vorlaufverteiler mit mikrometrischen Rücklaufverschraubungen, Luftablassventil und Ein-/Ablassventil. Rücklaufverteiler mit thermostatisierbaren Ventilen mit Einstellkappen, Luftablassventil und Ein-/Ablassventil, komplett mit Kappen und Befestigungsklammern

Collecteur d'alimentation avec coude de réglage micrométriques, vanne de purge de l'air et robinet de chargement/déchargement. Collecteur de retour avec vannes thermostatisables avec chapeaux de réglage, vanne de purge de l'air et robinet de chargement/déchargement, caps enthalten, bouchons et plaques d'ancrage inclus

Входной коллектор с микрометрическими отсекающими вентилями, воздухоотводчиком и краном впуск-выпуск. Обратный коллектор с термостатическими клапанами и регулирующими колпачками, воздухоотводчиком, краном впуск-выпуск и заглушками. В комплекте с кронштейнами.

Cod./Code	(F) Misura/Size	(G) Attacco/Connection	Vie/Ways	L(mm)	H(mm)	□/田	€
180322502	1"	3/4" EK	2	180	200	1	79,27
180322503	1"	3/4" EK	3	230	200	1	98,01
180322504	1"	3/4" EK	4	280	200	1	116,76
180322505	1"	3/4" EK	5	330	200	1	135,51
180322506	1"	3/4" EK	6	380	200	1	154,50
180322507	1"	3/4" EK	7	430	200	1	173,25
180322508	1"	3/4" EK	8	480	200	1	191,99
180322509	1"	3/4" EK	9	530	200	1	207,83
180322510	1"	3/4" EK	10	580	200	1	226,60
180322511	1"	3/4" EK	11	630	200	1	245,11
180322512	1"	3/4" EK	12	680	200	1	263,54
180332506	1"1/4	3/4" EK	6	380	200	1	172,68
180332507	1"1/4	3/4" EK	7	430	200	1	192,93
180332508	1"1/4	3/4" EK	8	480	200	1	213,26
180332509	1"1/4	3/4" EK	9	530	200	1	233,59
180332510	1"1/4	3/4" EK	10	580	200	1	254,18
180332511	1"1/4	3/4" EK	11	630	200	1	274,43
180332512	1"1/4	3/4" EK	12	680	200	1	294,76

IVR 804



Collettore di mandata con misuratori di portata; collettore di ritorno con valvole termostattizzabili con cappellotti di regolazione, tappi e zanche di fissaggio incluse

Inlet manifold with flow meters; return manifold with thermostatic valves with operating plastic caps, plugs and mounting brackets included

Vorlaufverteiler mit Durchflussmessern; Rücklaufverteiler mit thermostatisierbaren Ventilen mit Einstellkappen, komplett mit Kappen und Befestigungsklammern

Collecteur d'alimentation avec mesureurs de débit; collecteur de retour avec vannes thermostatisables avec chapeaux de réglage, bouchons et plaques d'ancrage inclus

Входной коллектор с расходомерами; Обратный коллектор с термостатическими клапанами и регулируемыми колпачками. Комплектуется с заглушками для коллектора и кронштейнами.

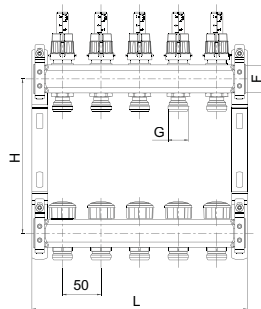

Cod./Code	(F) Misura/Size	(G) Attacco/Connection	Vie/Ways	L(mm)	H(mm)	□/田	€
180422502	1"	3/4" EK	2	130	200	1	70,14
180422503	1"	3/4" EK	3	180	200	1	94,19
180422504	1"	3/4" EK	4	230	200	1	118,71
180422505	1"	3/4" EK	5	280	200	1	142,77
180422506	1"	3/4" EK	6	330	200	1	167,07
180422507	1"	3/4" EK	7	380	200	1	191,59
180422508	1"	3/4" EK	8	430	200	1	215,64
180422509	1"	3/4" EK	9	480	200	1	239,70
180422510	1"	3/4" EK	10	530	200	1	261,64
180422511	1"	3/4" EK	11	580	200	1	285,39
180422512	1"	3/4" EK	12	630	200	1	309,20
180422513	1"	3/4" EK	13	680	200	1	333,41
180432506	1 1/4"	3/4" EK	6	330	200	1	188,16
180432507	1 1/4"	3/4" EK	7	380	200	1	214,90
180432508	1 1/4"	3/4" EK	8	430	200	1	241,10
180432509	1 1/4"	3/4" EK	9	480	200	1	267,38
180432510	1 1/4"	3/4" EK	10	530	200	1	294,46
180432511	1 1/4"	3/4" EK	11	580	200	1	320,67
180432512	1 1/4"	3/4" EK	12	630	200	1	346,87
180432513	1 1/4"	3/4" EK	13	680	200	1	373,06

IVR 804/R



Collettore di mandata con misuratori di portata e rubinetto di carico/scarico acqua; collettore di ritorno con valvola termostattizzabili con cappello di regolazione e rubinetto di carico/scarico acqua, tappi e zanche di fissaggio incluse

Inlet manifold with flow meters and fill & drain valve; outlet manifold with thermostatic valves with operating plastic cap and fill & drain valve, plugs and mounting brackets included

Vorlaufverteiler mit Durchflussmeter und ein-/Ablassventil; Rücklaufverteiler mit thermostatisierbaren Ventilen mit Einstellkappe und Ein-/Ablassventil, komplett mit Kappen und Befestigungsklammern

Collecteur d'alimentation avec mesureur de débit et robinet de chargement/déchargement; collecteur de retour avec vannes thermostatisables avec chapeau de réglage et robinet de chargement/déchargement, bouchons et plaques d'ancrage inclus

Входной коллектор с расходомерами и краном впуск-выпуск; Обратный коллектор с термостатическими клапанами и регулируемыми колпачками, кран впуск-выпуск

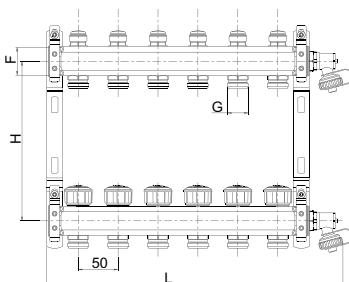

Cod./Code	(F) Misura/Size	(G) Attacco/Connection	Vie/Ways	L(mm)	H(mm)	□/田	€
1804R22502	1"	3/4" EK	2	171	200	1	80,94
1804R22503	1"	3/4" EK	3	221	200	1	105,00
1804R22504	1"	3/4" EK	4	271	200	1	129,51
1804R22505	1"	3/4" EK	5	321	200	1	153,57
1804R22506	1"	3/4" EK	6	371	200	1	177,87
1804R22507	1"	3/4" EK	7	421	200	1	202,39
1804R22508	1"	3/4" EK	8	471	200	1	226,44
1804R22509	1"	3/4" EK	9	521	200	1	250,50
1804R22510	1"	3/4" EK	10	571	200	1	272,45
1804R22511	1"	3/4" EK	11	621	200	1	296,19
1804R22512	1"	3/4" EK	12	671	200	1	320,01
1804R22513	1"	3/4" EK	13	721	200	1	344,22

IVR 805

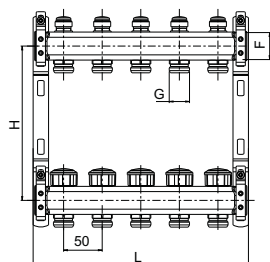

Collettore di mandata con detentori micrometrici; collettore di ritorno con valvole termostattizzabili con cappellini di regolazione, tappi e zanche di fissaggio incluse

Inlet manifold with micrometric lockshields; return manifold with thermostatic valves with operating plastic caps, plugs included, plugs and mounting brackets included

Vorlaufverteiler mit mikrometrischen Rücklaufverschraubungen; Rücklaufverteiler mit thermostatisierbaren Ventilen mit Einstellkappen, komplett mit Kappen und Befestigungsklammern

Collecteur d'alimentation avec coude de réglage micrométriques; collecteur de retour avec vannes thermostatisables avec chapeaux de réglage, bouchons et plaques d'ancrage inclus

Входной коллектор с микрометрическими отсекающими вентилями. Обратный коллектор с термостатическими клапанами и регулируемыми колпачками. Комплектуется с заглушками для коллектора и кронштейнами.

Cod./Code	(F) Misura/Size	(G) Attacco/Connection	Vie/Ways	L(mm)	H(mm)	□/田	€
180522502	1"	3/4" EK	2	130	200	1	59,06
180522503	1"	3/4" EK	3	180	200	1	77,80
180522504	1"	3/4" EK	4	230	200	1	96,55
180522505	1"	3/4" EK	5	280	200	1	115,30
180522506	1"	3/4" EK	6	330	200	1	134,04
180522507	1"	3/4" EK	7	380	200	1	153,04
180522508	1"	3/4" EK	8	430	200	1	171,78
180522509	1"	3/4" EK	9	480	200	1	190,53
180522510	1"	3/4" EK	10	530	200	1	206,70
180522511	1"	3/4" EK	11	580	200	1	225,14
180522512	1"	3/4" EK	12	630	200	1	243,64
180522513	1"	3/4" EK	13	680	200	1	262,07
180532506	1"1/4	3/4" EK	6	330	200	1	151,53
180532507	1"1/4	3/4" EK	7	380	200	1	171,86
180532508	1"1/4	3/4" EK	8	430	200	1	192,10
180532509	1"1/4	3/4" EK	9	480	200	1	212,43
180532510	1"1/4	3/4" EK	10	530	200	1	233,10
180532511	1"1/4	3/4" EK	11	580	200	1	253,35
180532512	1"1/4	3/4" EK	12	630	200	1	273,60
180532513	1"1/4	3/4" EK	13	680	200	1	293,93

IVR 805/R

NEW

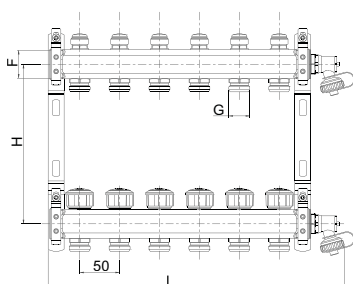

Collettore di mandata con detentori micrometrici e rubinetto di carico/scarico acqua; collettore di ritorno con valvole termostattizzabili con cappellino di regolazione e rubinetto di carico/scarico acqua, tappi e zanche di fissaggio incluse

Inlet manifold with micrometric lockshields and fill & drain valve; outlet manifold with thermostatic valves with operating plastic cap and fill & drain valve, plugs and mounting brackets included

Vorlaufverteiler mit mikrometrischen Rücklaufverschraubungen und Ein-/Ablassventil; Rücklaufverteiler mit thermostatisierbaren Ventilen mit Einstellkappe und Ein-/Ablassventil, komplett mit Kappen und Befestigungsklammern

Collecteur d'alimentation avec coude de réglage micrométrique et robinet de chargement/déchargement; collecteur de retour avec vannes thermostatisables avec chapeau de réglage et robinet de chargement/déchargement, bouchons et plaques d'ancrage inclus

Входной коллектор с микрометрическими отсекающими вентилями и краном впуск-выпуск; Обратный коллектор с термостатическими клапанами и регулирующим колпачком, кран впуск-выпуск. Комплектуется с заглушками для коллектора и кронштейнами.

Cod./Code	(F) Misura/Size	(G) Attacco/Connection	Vie/Ways	L(mm)	H(mm)	□/田	€
1805R22502	1"	3/4" EK	2	171	200	1	69,86
1805R22503	1"	3/4" EK	3	221	200	1	88,61
1805R22504	1"	3/4" EK	4	271	200	1	107,35
1805R22505	1"	3/4" EK	5	321	200	1	126,10
1805R22506	1"	3/4" EK	6	371	200	1	144,84
1805R22507	1"	3/4" EK	7	421	200	1	163,84
1805R22508	1"	3/4" EK	8	471	200	1	182,58
1805R22509	1"	3/4" EK	9	521	200	1	201,33
1805R22510	1"	3/4" EK	10	571	200	1	217,51
1805R22511	1"	3/4" EK	11	621	200	1	235,94
1805R22512	1"	3/4" EK	12	671	200	1	254,45
1805R22513	1"	3/4" EK	13	721	200	1	272,88

IVR 806

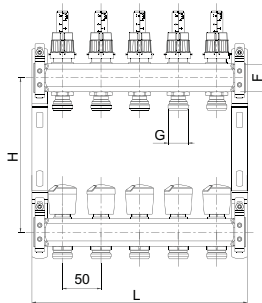

Collettore di mandata con misuratori di portata. Collettore di ritorno con valvole manuali con volantini, tappi e zanche di fissaggio incluse

Inlet manifold with flow meters. Return manifold with manual valves with handles, plugs and mounting brackets included

Vorlaufverteiler mit Durchflussmessern. Rücklaufverteiler mit Ventilen mit Handrädern, komplett mit Kapfen und Befestigungsklammern

Collecteur d'alimentation avec mesureurs de débit. Collecteur de retour avec vannes manuelles avec volants, bouchons et plaques d'ancrage inclus

Входной коллектор с расходомерами. Обратный коллектор с ручными регулирующими клапанами и заглушками. В комплекте с кронштейнами.

Cod./Code	(F) Misura/Size	(G) Attacco/Connection	Vie/Ways	L(mm)	H(mm)	□/田	€
180622502	1"	3/4" EK	2	130	200	1	71,76
180622503	1"	3/4" EK	3	180	200	1	96,39
180622504	1"	3/4" EK	4	230	200	1	121,96
180622505	1"	3/4" EK	5	280	200	1	146,59
180622506	1"	3/4" EK	6	330	200	1	171,46
180622507	1"	3/4" EK	7	380	200	1	197,04
180622508	1"	3/4" EK	8	430	200	1	221,66
180622509	1"	3/4" EK	9	480	200	1	246,29
180622510	1"	3/4" EK	10	530	200	1	269,30
180622511	1"	3/4" EK	11	580	200	1	293,61
180622512	1"	3/4" EK	12	630	200	1	318,00
180622513	1"	3/4" EK	13	680	200	1	340,16
180632506	1"1/4	3/4" EK	6	330	200	1	192,56
180632507	1"1/4	3/4" EK	7	380	200	1	220,07
180632508	1"1/4	3/4" EK	8	430	200	1	247,13
180632509	1"1/4	3/4" EK	9	480	200	1	273,98
180632510	1"1/4	3/4" EK	10	530	200	1	302,12
180632511	1"1/4	3/4" EK	11	580	200	1	328,44
180632512	1"1/4	3/4" EK	12	630	200	1	355,66
180632513	1"1/4	3/4" EK	13	680	200	1	380,36

IVR 807

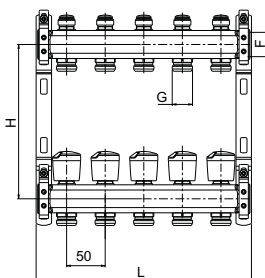

Collettore di mandata con detentori micrometrici. Collettore di ritorno con valvole manuali con volantini, tappi e zanche di fissaggio incluse

Inlet manifold with micrometric lockshields. Return manifold with manual valves with handles, plugs and mounting brackets included

Vorlaufverteiler mit mikrometrischen Rücklaufverschraubungen. Rücklaufverteiler mit Ventilen mit Handrädern, komplett mit Kapfen und Befestigungsklammern

Collecteur d'alimentation avec coude de réglage micrométriques. Collecteur de retour avec vannes manuelles avec volants, bouchons et plaques d'ancrage inclus

Входной коллектор с микрометрическими отсекающими вентилями. Обратный коллектор с ручными регулирующими клапанами и заглушками. В комплекте с кронштейнами.

Cod./Code	(F) Misura/Size	(G) Attacco/Connection	Vie/Ways	L(mm)	H(mm)	□/田	€
180722502	1"	3/4" EK	2	130	200	1	60,68
180722503	1"	3/4" EK	3	180	200	1	80,00
180722504	1"	3/4" EK	4	230	200	1	99,80
180722505	1"	3/4" EK	5	280	200	1	119,12
180722506	1"	3/4" EK	6	330	200	1	138,56
180722507	1"	3/4" EK	7	380	200	1	158,49
180722508	1"	3/4" EK	8	430	200	1	177,80
180722509	1"	3/4" EK	9	480	200	1	197,12
180722510	1"	3/4" EK	10	530	200	1	214,36
180722511	1"	3/4" EK	11	580	200	1	233,36
180722512	1"	3/4" EK	12	630	200	1	252,44
180722513	1"	3/4" EK	13	680	200	1	271,93
180732506	1"1/4	3/4" EK	6	330	200	1	155,80
180732507	1"1/4	3/4" EK	7	380	200	1	177,31
180732508	1"1/4	3/4" EK	8	430	200	1	198,39
180732509	1"1/4	3/4" EK	9	480	200	1	219,03
180732510	1"1/4	3/4" EK	10	530	200	1	240,76
180732511	1"1/4	3/4" EK	11	580	200	1	261,58
180732512	1"1/4	3/4" EK	12	630	200	1	282,40
180732513	1"1/4	3/4" EK	13	680	200	1	303,26

IVR 813

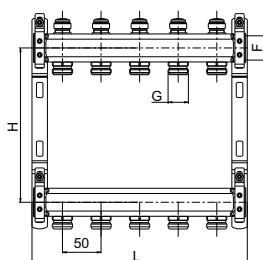

Collettore di mandata con detentori micrometrici. Collettore di ritorno con raccordi 3/4" Eurokonus, tappi e zanche di fissaggio incluse

Inlet manifold with micrometric lockshields. Return manifold with 3/4" Eurocone connections, plugs and mounting brackets included

Vorlaufverteiler mit mikrometrischen Rücklaufverschraubungen. Rücklaufverteiler mit 3/4" EK Verbindungsstücken, komplett mit Kappen und Befestigungsklammern

Collecteur d'alimentation avec coude de réglage micrométriques. Collecteur de retour avec sorties 3/4" EK, bouchons et plaques d'ancrage inclus

Входной коллектор с микрометрическими отсекающими вентилями. Обратный коллектор. Комплектуется с заглушками для коллектора и кронштейнами.

Cod./Code	(F) Misura/Size	(G) Attacco/Connection	Vie/Ways	L(mm)	H(mm)	□/田	€
181322502	1"	3/4" EK	2	130	200	1	51,00
181322503	1"	3/4" EK	3	180	200	1	65,72
181322504	1"	3/4" EK	4	230	200	1	80,44
181322505	1"	3/4" EK	5	280	200	1	95,16
181322506	1"	3/4" EK	6	330	200	1	110,12
181322507	1"	3/4" EK	7	380	200	1	124,84
181322508	1"	3/4" EK	8	430	200	1	139,56
181322509	1"	3/4" EK	9	480	200	1	154,28
181322510	1"	3/4" EK	10	530	200	1	167,88
181322511	1"	3/4" EK	11	580	200	1	182,44
181322512	1"	3/4" EK	12	630	200	1	197,08
181322513	1"	3/4" EK	13	680	200	1	211,60
181332506	1"1/4	3/4" EK	6	330	200	1	125,44
181332507	1"1/4	3/4" EK	7	380	200	1	141,43
181332508	1"1/4	3/4" EK	8	430	200	1	157,33
181332509	1"1/4	3/4" EK	9	480	200	1	173,31
181332510	1"1/4	3/4" EK	10	530	200	1	189,63
181332511	1"1/4	3/4" EK	11	580	200	1	205,54
181332512	1"1/4	3/4" EK	12	630	200	1	221,44
181332513	1"1/4	3/4" EK	13	680	200	1	237,42

IVR 814

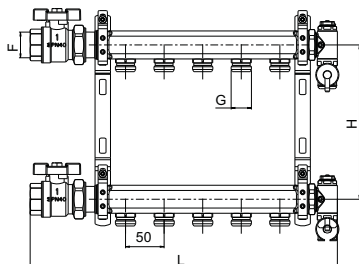

Collettore di mandata con collettore di ritorno con raccordi 3/4" Eurokonus, tappi e zanche di fissaggio incluse

Inlet manifold with return manifold with 3/4" Eurocone connections, plugs and mounting brackets included

Vorlaufverteiler mit Rücklaufverteiler mit 3/4" EK Verbindungsstücken, komplett mit Kappen und Befestigungsklammern

Collecteur d'alimentation avec collecteur de retour avec sorties 3/4" EK, bouchons et plaques d'ancrage inclus

Входной коллектор с обратным коллектором. Комплектуется с заглушками для коллектора и кронштейнами.

Cod./Code	(F) Misura/Size	(G) Attacco/Connection	Vie/Ways	L(mm)	H(mm)	□/田	€
181422502	1"	3/4" EK	2	130	200	1	46,14
181422503	1"	3/4" EK	3	180	200	1	58,42
181422504	1"	3/4" EK	4	230	200	1	70,71
181422505	1"	3/4" EK	5	280	200	1	83,00
181422506	1"	3/4" EK	6	330	200	1	95,28
181422507	1"	3/4" EK	7	380	200	1	107,82
181422508	1"	3/4" EK	8	430	200	1	120,10
181422509	1"	3/4" EK	9	480	200	1	132,39
181422510	1"	3/4" EK	10	530	200	1	145,02
181422511	1"	3/4" EK	11	580	200	1	157,31
181422512	1"	3/4" EK	12	630	200	1	169,67
181422513	1"	3/4" EK	13	680	200	1	181,88
181432506	1"1/4	3/4" EK	6	330	200	1	108,94
181432507	1"1/4	3/4" EK	7	380	200	1	122,17
181432508	1"1/4	3/4" EK	8	430	200	1	135,32
181432509	1"1/4	3/4" EK	9	480	200	1	148,55
181432510	1"1/4	3/4" EK	10	530	200	1	162,13
181432511	1"1/4	3/4" EK	11	580	200	1	175,28
181432512	1"1/4	3/4" EK	12	630	200	1	188,43
181432513	1"1/4	3/4" EK	13	680	200	1	201,66

COLLETTORI / MANIFOLDS

Collettori Inox / Inox Manifolds

AVANT FLOOR COMPONENTS



Collettore in acciaio inox AISI 304 1" - 1"1/4; Connessioni 3/4" EK - Interasse: 50 mm
AISI 304 stainless steel manifold 1" - 1"1/4; 3/4" Eurocone connections - Center hole distance 50 mm
Verteiler aus rostfreiem Edelstahl AISI 304 1" - 1"1/4; 3/4" Anschlüsse Eurokonus - Abstand 50 mm
Collecteur en acier inox AISI 304 1" - 1"1/4; connexion 3/4" eurocone - entraxes 50mm
Коллектор из нержавеющей стали AISI 304, размеры 1" - 1"1/4; 3/4", соединение Евроконус, межосевое расстояние 50 мм

IVR 875 CS



Collettore di ritorno con valvole, valvola sfogo aria e rubinetto di carico/scarico acqua
Return manifold with valves, air vent and fill & drain valve
Rücklaufverteiler mit Ventilen, Luftablassventil und Ein-/Ablassventil
Collecteur de retour avec vannes, vanne de purge d'air et robinet de chargement/déchargement
Обратный коллектор с термостатическими клапанами, воздухоотводчиком и дренажным клапаном

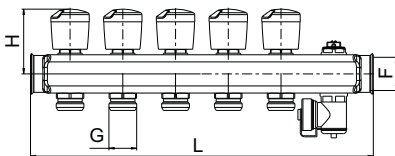

Cod./Code	(F) Misura/Size	(G) Attacco/Connection	Vie/Ways	L(mm)	H(mm)	□/田	€
187510502	1"	3/4" EK	2	175	61	6	36,00
187510503	1"	3/4" EK	3	225	61	4	46,84
187510504	1"	3/4" EK	4	275	61	4	58,02
187510505	1"	3/4" EK	5	325	61	4	68,87
187510506	1"	3/4" EK	6	375	61	6	79,59
187510507	1"	3/4" EK	7	425	61	6	90,91
187510508	1"	3/4" EK	8	475	61	6	101,65
187510509	1"	3/4" EK	9	525	61	6	111,09
187510510	1"	3/4" EK	10	575	61	6	122,16
187510511	1"	3/4" EK	11	625	61	6	132,78
187510512	1"	3/4" EK	12	675	61	6	143,37
187512506	1"1/4	3/4" EK	6	375	66	1	84,05
187512507	1"1/4	3/4" EK	7	425	66	1	95,51
187512508	1"1/4	3/4" EK	8	475	66	1	107,00
187512509	1"1/4	3/4" EK	9	525	66	1	118,49
187512510	1"1/4	3/4" EK	10	575	66	1	129,94
187512511	1"1/4	3/4" EK	11	625	66	1	141,40
187512512	1"1/4	3/4" EK	12	675	66	1	152,89

IVR 875



Collettore di ritorno con valvole manuali e volantini manuali
Return manifold with manual valves and manual handles
Rücklaufverteiler mit Regulierventil und Handrädern
Collecteur de retour avec vannes manuelles
Обратный коллектор с ручными регулируемыми клапанами

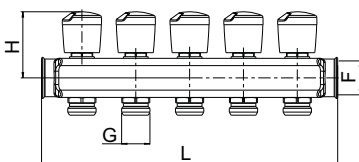

Cod./Code	(F) Misura/Size	(G) Attacco/Connection	Vie/Ways	L(mm)	H(mm)	□/田	€
187511502	1"	3/4" EK	2	125	61	6/18	25,89
187511503	1"	3/4" EK	3	175	61	3/12	36,76
187511504	1"	3/4" EK	4	225	61	3/9	48,07
187511505	1"	3/4" EK	5	275	61	4	58,69
187511506	1"	3/4" EK	6	325	61	9	69,35
187511507	1"	3/4" EK	7	375	61	10	80,62
187511508	1"	3/4" EK	8	425	61	7	91,49
187511509	1"	3/4" EK	9	475	61	7	102,23
187511510	1"	3/4" EK	10	525	61	7	112,13
187511511	1"	3/4" EK	11	575	61	7	122,71
187511512	1"	3/4" EK	12	625	61	7	133,34
187511513	1"	3/4" EK	13	675	61	7	143,88
187513506	1"1/4	3/4" EK	6	325	66	1	73,47
187513507	1"1/4	3/4" EK	7	375	66	1	84,97
187513508	1"1/4	3/4" EK	8	425	66	1	96,42
187513509	1"1/4	3/4" EK	9	475	66	1	108,96
187513510	1"1/4	3/4" EK	10	525	66	1	119,41
187513511	1"1/4	3/4" EK	11	575	66	1	130,86
187513512	1"1/4	3/4" EK	12	625	66	1	142,31
187513513	1"1/4	3/4" EK	13	675	66	1	153,80

IVR 877 CS

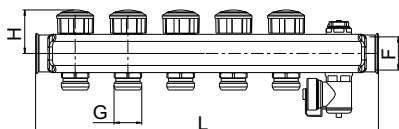

Collettore di ritorno con valvole termostattizzabili e cappellotti di regolazione, valvola sfogo aria e rubinetto di carico/scarico acqua

Return manifold with thermostatic valves and operating plastic caps, air vent and fill & drain valve

Rücklaufverteiler mit thermostatisierbaren Ventilen und Handrädern, Luftablassventil und Ein-/Ablassventil

Collecteur de retour avec vannes thermostatissables et chapeaux de réglage, vanne de purge d'air et robinet de chargement/déchargement

Обратный коллектор с термостатическими клапанами и регулируемыми колпачками, воздухоотводчиком и дренажным клапаном.

Cod./Code	(F) Misura/Size	(G) Attacco/Connection	Vie/Ways	L(mm)	H(mm)	□/田	€
187710502	1"	3/4" EK	2	175	41	4/24	34,45
187710503	1"	3/4" EK	3	225	41	4/12	44,62
187710504	1"	3/4" EK	4	275	41	4	54,77
187710505	1"	3/4" EK	5	325	41	5	64,97
187710506	1"	3/4" EK	6	375	41	9	75,05
187710507	1"	3/4" EK	7	425	41	8	85,35
187710508	1"	3/4" EK	8	475	41	8	95,52
187710509	1"	3/4" EK	9	525	41	8	104,35
187710510	1"	3/4" EK	10	575	41	8	114,36
187710511	1"	3/4" EK	11	625	41	8	124,42
187710512	1"	3/4" EK	12	675	41	8	134,43
187712506	1"1/4	3/4" EK	6	375	46	10	81,43
187712507	1"1/4	3/4" EK	7	425	46	10	92,35
187712508	1"1/4	3/4" EK	8	475	46	1	102,76
187712509	1"1/4	3/4" EK	9	525	46	1	113,72
187712510	1"1/4	3/4" EK	10	575	46	1	124,64
187712511	1"1/4	3/4" EK	11	625	46	1	135,56
187712512	1"1/4	3/4" EK	12	675	46	1	146,52

IVR 877

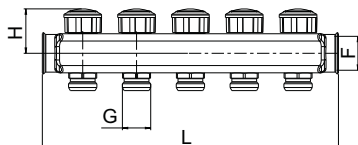

Collettore di ritorno con valvole termostattizzabili e cappellotti di regolazione

Return manifold with thermostatic valves and operating manual caps

Rücklaufverteiler mit Regulierventilen (für thermoelektrischen Kopf) und Handrädern

Collecteur de retour avec vannes thermostatissables, et chapeaux de réglage

Обратный коллектор с термостатическими клапанами и регулируемыми колпачками

Cod./Code	(F) Misura/Size	(G) Attacco/Connection	Vie/Ways	L(mm)	H(mm)	□/田	€
187711502	1"	3/4" EK	2	125	41	4/24	24,21
187711503	1"	3/4" EK	3	175	41	4/24	34,51
187711504	1"	3/4" EK	4	225	41	8	44,58
187711505	1"	3/4" EK	5	275	41	8	54,72
187711506	1"	3/4" EK	6	325	41	5	65,04
187711507	1"	3/4" EK	7	375	41	9	75,13
187711508	1"	3/4" EK	8	425	41	8	85,42
187711509	1"	3/4" EK	9	475	41	8	95,59
187711510	1"	3/4" EK	10	525	41	8	104,42
187711511	1"	3/4" EK	11	575	41	8	114,43
187711512	1"	3/4" EK	12	625	41	8	124,48
187711513	1"	3/4" EK	13	675	41	8	134,50
187713506	1"1/4	3/4" EK	6	325	46	1	70,29
187713507	1"1/4	3/4" EK	7	375	46	1	81,26
187713508	1"1/4	3/4" EK	8	425	46	1	92,18
187713509	1"1/4	3/4" EK	9	475	46	1	103,14
187713510	1"1/4	3/4" EK	10	525	46	1	114,10
187713511	1"1/4	3/4" EK	11	575	46	1	125,03
187713512	1"1/4	3/4" EK	12	625	46	1	135,95
187713513	1"1/4	3/4" EK	13	675	46	1	146,91



IVR 877/R

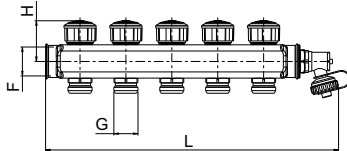

Collettore di ritorno con valvole termostattizzabili con cappello di regolazione e con rubinetto di carico/scarico acqua

Outlet manifold with thermostatic valves with operating plastic cap and fill & drain valve

Rücklaufverteiler mit thermostatisierbaren Ventilen mit Einstellkappe und Ein-/Ablassventil

Collecteur de retour avec vannes thermostatissables avec chapeau de réglage et avec robinet de chargement/déchargement

Обратный коллектор с термостатическими клапанами, регулирующим колпачком и дренажным клапаном.

Cod./Code	(F) Misura/Size	(G) Attacco/Connection	Vie/Ways	L(mm)	H(mm)	□/田	€
1877R11502	1"	3/4" EK	2	169	41	1	31,74
1877R11503	1"	3/4" EK	3	219	41	1	41,91
1877R11504	1"	3/4" EK	4	269	41	1	51,99
1877R11505	1"	3/4" EK	5	319	41	1	62,13
1877R11506	1"	3/4" EK	6	369	41	1	72,44
1877R11507	1"	3/4" EK	7	419	41	1	82,54
1877R11508	1"	3/4" EK	8	469	41	1	92,83
1877R11509	1"	3/4" EK	9	519	41	1	103,00
1877R11510	1"	3/4" EK	10	569	41	1	111,82
1877R11511	1"	3/4" EK	11	619	41	1	121,84
1877R11512	1"	3/4" EK	12	669	41	1	131,89
1877R11513	1"	3/4" EK	13	719	41	1	141,90

IVR 878 CS

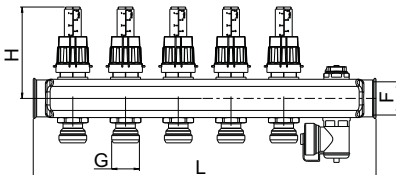

Collettore di mandata con misuratori di portata 0,5-5 lt/min. valvola sfogo aria, rubinetto di carico/scarico acqua

Inlet manifold with flow meters 0,5-5 L/min, air vent and fill & drain valve

Vorlaufverteiler mit Durchflussmessern 0,5-5 lt/min. Luftablassventil und Ein-/Ablassventil

Collecteur d'alimentation avec débitmètres 0,5-5 lt/min., vanne de purge de l'air et robinet de chargement/déchargement

Входной коллектор с расходомерами 0,5-5 л/мин, воздухоотводчиком и дренажным клапаном

Cod./Code	(F) Misura/Size	(G) Attacco/Connection	Vie/Ways	L(mm)	H(mm)	□/田	€
187810502	1"	3/4" EK	2	175	93	1	42,24
187810503	1"	3/4" EK	3	225	93	1	56,20
187810504	1"	3/4" EK	4	275	93	1	70,54
187810505	1"	3/4" EK	5	325	93	1	84,85
187810506	1"	3/4" EK	6	375	93	1	98,37
187810507	1"	3/4" EK	7	425	93	1	112,72
187810508	1"	3/4" EK	8	475	93	1	126,68
187810509	1"	3/4" EK	9	525	93	1	139,26
187810510	1"	3/4" EK	10	575	93	1	153,45
187810511	1"	3/4" EK	11	625	93	1	167,21
187810512	1"	3/4" EK	12	675	93	1	180,94
187812506	1"1/4	3/4" EK	6	375	98	1	107,93
187812507	1"1/4	3/4" EK	7	425	98	1	123,67
187812508	1"1/4	3/4" EK	8	475	98	1	138,98
187812509	1"1/4	3/4" EK	9	525	98	1	154,30
187812510	1"1/4	3/4" EK	10	575	98	1	170,04
187812511	1"1/4	3/4" EK	11	625	98	1	185,32
187812512	1"1/4	3/4" EK	12	675	98	1	200,64

IVR 878



Collettore di mandata con misuratori di portata 0,5-5 lt/min.

Inlet manifold with flow meters 0,5-5 L/min

Vorlaufverteiler mit Durchflussmessern 0,5-5 lt/min

Collecteur d'alimentation avec débitmètres 0,5-5 lt/min

Входной коллектор с расходомерами 0,5-5 л/мин

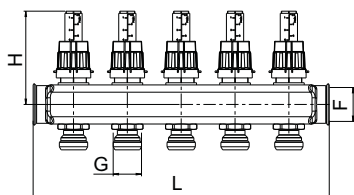

Cod./Code	(F) Misura/Size	(G) Attacco/Connection	Vie/Ways	L(mm)	H(mm)	□/田	€
187811502	1"	3/4" EK	2	125	93	1	32,09
187811503	1"	3/4" EK	3	175	93	1	46,04
187811504	1"	3/4" EK	4	225	93	1	60,45
187811505	1"	3/4" EK	5	275	93	1	74,32
187811506	1"	3/4" EK	6	325	93	1	88,63
187811507	1"	3/4" EK	7	375	93	1	102,61
187811508	1"	3/4" EK	8	425	93	1	116,50
187811509	1"	3/4" EK	9	475	93	1	130,46
187811510	1"	3/4" EK	10	525	93	1	143,50
187811511	1"	3/4" EK	11	575	93	1	157,23
187811512	1"	3/4" EK	12	625	93	1	170,99
187811513	1"	3/4" EK	13	675	93	1	172,27
187813506	1"1/4	3/4" EK	6	325	98	1	97,35
187813507	1"1/4	3/4" EK	7	375	98	1	113,13
187813508	1"1/4	3/4" EK	8	425	98	1	128,41
187813509	1"1/4	3/4" EK	9	475	98	1	143,72
187813510	1"1/4	3/4" EK	10	525	98	1	159,50
187813511	1"1/4	3/4" EK	11	575	98	1	174,78
187813512	1"1/4	3/4" EK	12	625	98	1	190,06
187813513	1"1/4	3/4" EK	13	675	98	1	205,84

IVR 878/R

NEW



Collettore di mandata con misuratori di portata 0,5-5 lt/min e con rubinetto di carico/scarico acqua

Inlet manifold with flow meters 0,5-5 L/min and fill & drain valve

Vorlaufverteiler mit Durchflussmesser 0,5-5 lt/Min. und Ein-/Ablassventil

Collecteur d'alimentation avec mesureur de débit 0,5-5 lt/min et avec robinet de chargement/déchargement

Входной коллектор с расходомерами 0,5-5 л/мин и дренажным клапаном

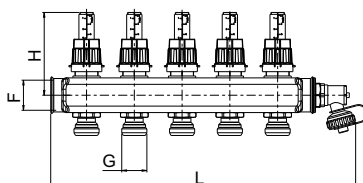

Cod./Code	(F) Misura/Size	(G) Attacco/Connection	Vie/Ways	L(mm)	H(mm)	□/田	€
1878R11502	1"	3/4" EK	2	169	93	1	39,66
1878R11503	1"	3/4" EK	3	219	93	1	53,45
1878R11504	1"	3/4" EK	4	269	93	1	67,86
1878R11505	1"	3/4" EK	5	319	93	1	81,73
1878R11506	1"	3/4" EK	6	369	93	1	96,03
1878R11507	1"	3/4" EK	7	419	93	1	110,02
1878R11508	1"	3/4" EK	8	469	93	1	123,91
1878R11509	1"	3/4" EK	9	519	93	1	137,87
1878R11510	1"	3/4" EK	10	569	93	1	150,90
1878R11511	1"	3/4" EK	11	619	93	1	164,63
1878R11512	1"	3/4" EK	12	669	93	1	178,40
1878R11513	1"	3/4" EK	13	719	93	1	179,68

IVR 879 CS



Collettore di mandata con detentori micrometrici, valvola sfogo aria, rubinetto di carico/scarico acqua

Inlet manifold with micrometric lockshields, air vent, fill & drain valve

Vorlaufverteiler mit mikrometrischen Rücklaufverschraubungen und Ein-/Ablassventil

Collecteur d'alimentation avec coudes de réglage micrométriques, vanne de purge de l'air, robinet de chargement/déchargement

Входной коллектор с микрометрическими отсекающими клапанами, воздухоотводчиком и дренажным клапаном

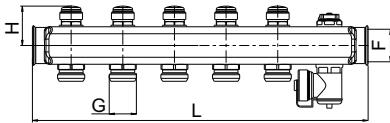

Cod./Code	(F) Misura/Size	(G) Attacco/Connection	Vie/Ways	L(mm)	H(mm)	□/田	€
187910502	1"	3/4" EK	2	175	38	1	31,38
187910503	1"	3/4" EK	3	225	38	1	39,94
187910504	1"	3/4" EK	4	275	38	1	48,50
187910505	1"	3/4" EK	5	325	38	1	57,11
187910506	1"	3/4" EK	6	375	38	1	65,61
187910507	1"	3/4" EK	7	425	38	1	74,31
187910508	1"	3/4" EK	8	475	38	1	82,89
187910509	1"	3/4" EK	9	525	38	1	90,12
187910510	1"	3/4" EK	10	575	38	1	98,54
187910511	1"	3/4" EK	11	625	38	1	106,99
187910512	1"	3/4" EK	12	675	38	1	115,41
187912506	1"1/4	3/4" EK	6	375	43	1	71,85
187912507	1"1/4	3/4" EK	7	425	43	1	81,18
187912508	1"1/4	3/4" EK	8	475	43	1	89,99
187912509	1"1/4	3/4" EK	9	525	43	1	99,35
187912510	1"1/4	3/4" EK	10	575	43	1	108,68
187912511	1"1/4	3/4" EK	11	625	43	1	118,01
187912512	1"1/4	3/4" EK	12	675	43	1	127,37

IVR 879



Collettore di mandata con detentori micrometrici

Inlet manifold with micrometric lockshields

Vorlaufverteiler mit mikrometrischen Rücklaufverschraubungen

Collecteur d'alimentation avec coudes de réglage micrométriques

Входной коллектор с микрометрическими отсекающими клапанами

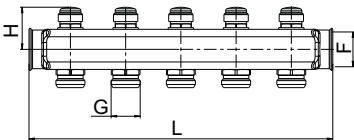

Cod./Code	(F) Misura/Size	(G) Attacco/Connection	Vie/Ways	L(mm)	H(mm)	□/田	€
187911502	1"	3/4" EK	2	125	38	1	21,02
187911503	1"	3/4" EK	3	175	38	1	29,75
187911504	1"	3/4" EK	4	225	38	1	38,20
187911505	1"	3/4" EK	5	275	38	1	46,75
187911506	1"	3/4" EK	6	325	38	1	55,37
187911507	1"	3/4" EK	7	375	38	1	63,96
187911508	1"	3/4" EK	8	425	38	1	72,65
187911509	1"	3/4" EK	9	475	38	1	81,23
187911510	1"	3/4" EK	10	525	38	1	88,46
187911511	1"	3/4" EK	11	575	38	1	96,87
187911512	1"	3/4" EK	12	625	38	1	105,33
187911513	1"	3/4" EK	13	675	38	1	113,75
187913506	1"1/4	3/4" EK	6	325	43	1	60,72
187913507	1"1/4	3/4" EK	7	375	43	1	70,08
187913508	1"1/4	3/4" EK	8	425	43	1	79,41
187913509	1"1/4	3/4" EK	9	475	43	1	88,78
187913510	1"1/4	3/4" EK	10	525	43	1	98,14
187913511	1"1/4	3/4" EK	11	575	43	1	107,47
187913512	1"1/4	3/4" EK	12	625	43	1	116,79
187913513	1"1/4	3/4" EK	13	675	43	1	126,16

IVR 879/R

NEW

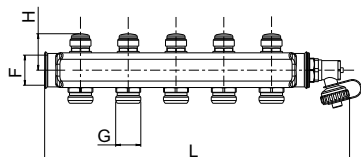

Collettore di mandata con detentori micrometrici e con rubinetto di carico/scarico acqua

Inlet manifold with micrometric lockshields and fill & drain valve

Vorlaufverteiler mit mikrometrischen Rücklaufverschraubungen und Ein-/Ablassventil

Collecteur d'alimentation avec coudes de réglage micrométriques et avec robinet de chargement/déchargement

Входной коллектор с микрометрическими отсекающими вентилями и дренажным клапаном

Cod./Code	(F) Misura/Size	(G) Attacco/Connection	Vie/Ways	L(mm)	H(mm)	□/田	€
1879R11502	1"	3/4" EK	2	169	38	1	28,55
1879R11503	1"	3/4" EK	3	219	38	1	37,15
1879R11504	1"	3/4" EK	4	269	38	1	45,61
1879R11505	1"	3/4" EK	5	319	38	1	54,15
1879R11506	1"	3/4" EK	6	369	38	1	62,78
1879R11507	1"	3/4" EK	7	419	38	1	71,36
1879R11508	1"	3/4" EK	8	469	38	1	80,06
1879R11509	1"	3/4" EK	9	519	38	1	88,63
1879R11510	1"	3/4" EK	10	569	38	1	95,86
1879R11511	1"	3/4" EK	11	619	38	1	104,28
1879R11512	1"	3/4" EK	12	669	38	1	112,74
1879R11513	1"	3/4" EK	13	719	38	1	121,15

COLLETTORI / MANIFOLDS

Collettori Inox / Inox Manifolds
AVANT FLOOR BASIC



Collettore in acciaio inox AISI 304 1" - 1"1/4; Interasse: 50 mm

AISI 304 stainless steel manifold 1" - 1"1/4; Center hole distance 50 mm

Verteiler aus rostfreiem Stahl AISI 304 1" - 1"1/4 Anschlüsse; Abstand 50 mm

Collecteur en acier inox AISI 304 1" - 1"1/4; entraxes 50 mm

Коллектор из нержавеющей стали AISI 304, размеры 1" - 1"1/4; соединения Евроконус, межосевое расстояние 50 мм

IVR 871

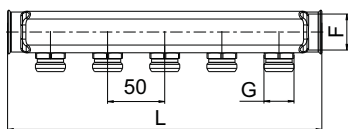

Cod./Code	(F) Misura/Size	(G) Attacco/Connection	Vie/Ways	L(mm)	H(mm)	□/田	€
187111502	1"	3/4" EK	2	125	6/36	17,31	
187111503	1"	3/4" EK	3	175	6/36	24,00	
187111504	1"	3/4" EK	4	225	6/18	30,62	
187111505	1"	3/4" EK	5	275	10	37,14	
187111506	1"	3/4" EK	6	325	8	43,81	
187111507	1"	3/4" EK	7	375	12	50,40	
187111508	1"	3/4" EK	8	425	12	57,05	
187111509	1"	3/4" EK	9	475	12	63,66	
187111510	1"	3/4" EK	10	525	16	70,28	
187111511	1"	3/4" EK	11	575	16	76,88	
187111512	1"	3/4" EK	12	625	16	83,53	
187111513	1"	3/4" EK	13	675	16	89,88	
187113506	1"1/4	3/4" EK	6	325	1	47,56	
187113507	1"1/4	3/4" EK	7	375	1	54,67	
187113508	1"1/4	3/4" EK	8	425	1	61,73	
187113509	1"1/4	3/4" EK	9	475	1	68,85	
187113510	1"1/4	3/4" EK	10	525	1	75,95	
187113511	1"1/4	3/4" EK	11	575	1	83,02	
187113512	1"1/4	3/4" EK	12	625	1	90,09	
187113513	1"1/4	3/4" EK	13	675	1	97,20	

IVR 868

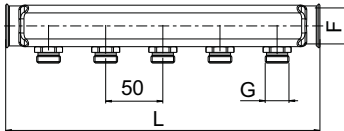

Cod./Code	(F) Misura/Size	(G) Attacco/Connection	Vie/Ways	L(mm)	□/田	€
186811502	1"	1/2"	2	125	6/36	14,22
186811503	1"	1/2"	3	175	6/36	19,36
186811504	1"	1/2"	4	225	6/18	24,50
186811505	1"	1/2"	5	275	10	29,41
186811506	1"	1/2"	6	325	8	34,39
186811507	1"	1/2"	7	375	12	39,51
186811508	1"	1/2"	8	425	12	44,50
186811509	1"	1/2"	9	475	12	49,55
186811510	1"	1/2"	10	525	16	54,61
186811511	1"	1/2"	11	575	16	59,67
186811512	1"	1/2"	12	625	16	64,76
186811513	1"	1/2"	13	675	16	69,78
186813506	1"1/4	1/2"	6	325	1	38,28
186813507	1"1/4	1/2"	7	375	1	43,84
186813508	1"1/4	1/2"	8	425	1	49,36
186813509	1"1/4	1/2"	9	475	1	54,92
186813510	1"1/4	1/2"	10	525	1	60,49
186813511	1"1/4	1/2"	11	575	1	66,01
186813512	1"1/4	1/2"	12	625	1	71,53
186813513	1"1/4	1/2"	13	675	1	69,78

IVR 869

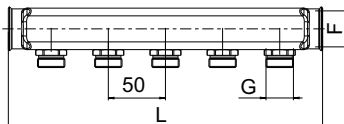

Cod./Code	(F) Misura/Size	(G) Attacco/Connection	Vie/Ways	L(mm)	□/田	€
186911502	1"	24-19	2	125	6/36	14,99
186911503	1"	24-19	3	175	6/36	20,50
186911504	1"	24-19	4	225	6/18	26,04
186911505	1"	24-19	5	275	10	31,33
186911506	1"	24-19	6	325	8	36,70
186911507	1"	24-19	7	375	12	42,14
186911508	1"	24-19	8	425	12	47,58
186911509	1"	24-19	9	475	12	53,02
186911510	1"	24-19	10	525	16	58,46
186911511	1"	24-19	11	575	16	63,90
186911512	1"	24-19	12	625	16	69,38
186911513	1"	24-19	13	675	16	74,78
186913506	1"1/4	24-19	6	325	1	40,59
186913507	1"1/4	24-19	7	375	1	46,53
186913508	1"1/4	24-19	8	425	1	52,44
186913509	1"1/4	24-19	9	475	1	58,39
186913510	1"1/4	24-19	10	525	1	64,34
186913511	1"1/4	24-19	11	575	1	70,24
186913512	1"1/4	24-19	12	625	1	76,15
186913513	1"1/4	24-19	13	675	1	82,10

IVR 867

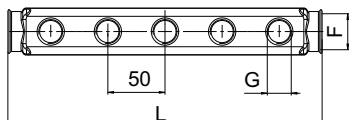

Cod./Code	(F) Misura/Size	(G) Attacco/Connection	Vie/Ways	L(mm)	□/田	€
186711502	1"	1/2" F	2	125	8/48	8,45
186711503	1"	1/2" F	3	175	8/48	11,57
186711504	1"	1/2" F	4	225	8/24	14,63
186711505	1"	1/2" F	5	275	12	17,62
186711506	1"	1/2" F	6	325	10	20,70
186711507	1"	1/2" F	7	375	18	23,71
186711508	1"	1/2" F	8	425	20	26,79
186711509	1"	1/2" F	9	475	20	29,73
186711510	1"	1/2" F	10	525	20	32,77
186711511	1"	1/2" F	11	575	20	35,82
186711512	1"	1/2" F	12	625	20	38,90
186711513	1"	1/2" F	13	675	20	41,90
<hr/>						
186713506	1"1/4	1/2" F	6	325	8	24,63
186713507	1"1/4	1/2" F	7	375	8	28,18
186713508	1"1/4	1/2" F	8	425	14	31,69
186713509	1"1/4	1/2" F	9	475	14	35,25
186713510	1"1/4	1/2" F	10	525	16	38,83
186713511	1"1/4	1/2" F	11	575	16	42,34
186713512	1"1/4	1/2" F	12	625	16	45,85
186713513	1"1/4	1/2" F	13	675	16	49,40

IVR MULTIKLIMA Distribuzione / Distribution

IVR MULTIKLIMA 525



Interasse attacco tubazioni: 277 mm.
Pipe connection center to center: 277 mm.

Modulo di distribuzione per alta e bassa temperatura con collettori in acciaio inox AISI 304 da 1" x 3/4" EK da 2 a 12 derivazioni con 2 derivazioni (o 3 su richiesta) per alta temperatura; collettori completi di: valvole d'intercettazione, valvole termostattizzabili, misuratori di portata, rubinetto orientabile di carico scarico, valvola sfiato aria. Gruppo di miscelazione modulante con servocomando elettrotermico e gruppo by-pass con termostato di sicurezza, detentore micrometrico e pozzetto porta sonda.

Water distribution cabinet for high and low temperature with AISI 304 stainless steel manifolds 1"x3/4" EK, 2-12 ways; with 2 ways (or 3 on demand) for high temperature; fitted with: interception valves, thermostatic valves, flow meters, rotatable drain valve and air vent. Modulating mixing unit with electrothermal actuator and by-pass group with safety thermostat, micrometric lockshield and sensor connection.

Verteilermodul für hohe und niedrige Temperatur mit Verteilerrohren aus rostfreiem Stahl AISI 304 mit Ek Übergang 1"x3/4", mit 2-12 Abzweigungen (oder 3 auf Anfrage) für hohe Temperatur; ausgestattet mit: Absperrventilen, thermostatisierbaren Ventilen, Durchflussmessern, drehbarem Ein-/Ablassventil und Luftablassventil. Modulierende Mischerguppe mit elektrothermischem Servosteuern und Bypass-Gruppe mit Sicherheitsthermostat, mikrometrischem Regelventil und Sondenaufnahme.

Module de distribution pour haute et basse température, avec collecteurs en acier inoxydable AISI304, de 1" x 3/4" EK e 1" 1/4 x 3/4" EK, à 2 dérivation (ou 3 sur demande) pour température haute; pourvus de: vannes d'arrêt, vannes thermostatisables, débitmètres, robinet orientable de chargement/déchargement, vanne de purge de l'air. Groupe de mélange modulante avec servocommande électrothermique et groupe by-pass avec thermostat de sécurité, coude de réglage micrométrique et puisard porte-sonde.

Распределительный модуль для низкой и высокой температуры с коллекторами сделан из нержавеющей стали AISI 304 1" x 3/4" Евроконус, от 2 до 12 отводов, с двумя ответвлениями (с тремя - под заказ) для высокой температуры. Состоит из: шарового крана для насоса, термостатических клапанов, расходомера, дренажного крана, воздушного клапана и крепления. Также входит: модулирующая смесительная группа с термоэлектрическим приводом и группой бай-пасс с предохранительным термостатом, микрометрическим отсекающим вентилем и подключением температурного зонда.

Cod. Sx/Left	Cod. Dx/Right	Vie/Ways	L(mm)	H(mm)	P(mm)	€
52503232GA	52513232GA	2 + 2	850	750	110	870,03
52503232GB	52513232GB	2 + 3	850	750	110	893,56
52503232GC	52513232GC	2 + 4	850	750	110	917,36
52503232GD	52513232GD	2 + 5	1000	750	110	961,48
52503232GE	52513232GE	2 + 6	1000	750	110	984,07
52503232GF	52513232GF	2 + 7	1000	750	110	1008,07
52503232GG	52513232GG	2 + 8	1200	750	110	1052,10
52503232GH	52513232GH	2 + 9	1200	750	110	1072,60
52503232GJ	52513232GJ	2 + 10	1200	750	110	1096,12
52503232GK	52513232GK	2 + 11	1200	750	110	1119,33
52503232GL	52513232GL	2 + 12	1300	750	110	1164,13

Versione con circolatore volumetrico in Classe A
Version with Class A volumetric pump
Ausführung mit Class A Umlaufpumpe
Version avec class A pompe volumétrique
Версия с циркуляционным насосом класса А

Cod. Sx/Left	Cod. Dx/Right	Vie/Ways	L(mm)	H(mm)	P(mm)	€
52502232GA	52512232GA	2 + 2	850	750	110	772,53
52502232GB	52512232GB	2 + 3	850	750	110	796,06
52502232GC	52512232GC	2 + 4	850	750	110	819,86
52502232GD	52512232GD	2 + 5	1000	750	110	863,98
52502232GE	52512232GE	2 + 6	1000	750	110	886,57
52502232GF	52512232GF	2 + 7	1000	750	110	910,57
52502232GG	52512232GG	2 + 8	1200	750	110	954,60
52502232GH	52512232GH	2 + 9	1200	750	110	975,10
52502232GJ	52512232GJ	2 + 10	1200	750	110	998,62
52502232GK	52512232GK	2 + 11	1200	750	110	1021,83
52502232GL	52512232GL	2 + 12	1300	750	110	1066,63

Versione con circolatore a tre velocità (solo per paesi extra CEE)
Version with 3 speed pump (only for extra CEE country)
Ausführung mit 3-Gang-Pumpe (nur für Klein CEE-Land)
Version avec pompe à 3 vitesses (uniquement pour les pays extra CEE)
Версия с трехскоростным насосом (только для стран, не входящих в ЕС)

Cod. Sx/Left	Cod. Dx/Right	Vie/Ways	L(mm)	H(mm)	P(mm)	€
52501232GA	52511232GA	2 + 2	850	750	110	651,00
52501232GB	52511232GB	2 + 3	850	750	110	674,53
52501232GC	52511232GC	2 + 4	850	750	110	698,33
52501232GD	52511232GD	2 + 5	1000	750	110	742,45
52501232GE	52511232GE	2 + 6	1000	750	110	765,04
52501232GF	52511232GF	2 + 7	1000	750	110	789,04
52501232GG	52511232GG	2 + 8	1200	750	110	833,07
52501232GH	52511232GH	2 + 9	1200	750	110	853,57
52501232GJ	52511232GJ	2 + 10	1200	750	110	877,09
52501232GK	52511232GK	2 + 11	1200	750	110	900,30
52501232GL	52511232GL	2 + 12	1300	750	110	945,10

Versione senza circolatore (con tronchetto spaziatore)
Version without pump (with pipes pre-mounted)
Ausführung ohne Pumpe (mit Balken vormontiert)
Version sans pompe (avec des tuyaux pré-monté)
Версия без насоса (с предустановленными трубами)

IVR MULTIKLIMA 523



Modulo di distribuzione per alta e bassa temperatura con collettori in acciaio inox AISI 304 da 1" x 3/4" EK da 2 a 12 derivazioni con 2 derivazioni (o 3 su richiesta) per alta temperatura; collettori completi di: valvole d'intercettazione, valvole termostattizzabili, misuratori di portata, rubinetto orientabile di carico scarico, valvola sfiato aria. Gruppo di miscelazione a punto fisso con miscelatore termostatico e gruppo by-pass con termostato di sicurezza, detentore micrometrico e pozzetto porta sonda.

Water distribution cabinet for high and low temperature with AISI 304 stainless steel manifolds 1"x3/4" EK, 2-12 ways; with 2 ways (or 3 on demand) for high temperature; fitted with: interception valves, thermostatic valves, flow meters, rotatable drain valve and air vent. Mixing unit with fixed point with thermostatic head and by-pass group with safety thermostat, micrometric lockshield and sensor connection.

Verteilermodul für hohe und niedrige Temperatur, mit Verteilerröhren aus rostfreiem Stahl AISI 304 mit Ek Übergang 1"x3/4", mit 2-12 Abzweigungen (oder 3 auf Anfrage) für hohe Temperatur; ausgestattet mit: Absperrventilen, thermostatisierbaren Ventilen, Durchflussmessern, drehbarem Ein-/Ablassventil und Luftablassventil. Fest eingestellte Mischerguppe mit thermostatischem Kopf und Bypass-Gruppe mit Sicherheitsthermostat, mikrometrischem Regelventil und Sondenaufnahme.

Module de distribution pour haute et basse température avec collecteurs en acier inoxydable AISI304, de 1" x 3/4" EK, à 2 dérivation (ou 3 sur demande) pour température haute; pourvus de: vannes d'arrêt, vannes thermostatisables, débitmètres, robinet orientable de chargement/déchargement, vanne de purge de l'air. Groupe de mélange à point fixe avec mitigeur thermostatique et groupe by-pass avec thermostat de sécurité, coude de réglage micrométrique et puisard porte-sonde.

Распределительный модуль для низкой и высокой температуры с коллекторами из нержавеющей стали AISI 304 1" x 3/4" Евроконус, от 2 до 12 отводов, с двумя ниями (с тремя - под заказ) для высокой температуры. Состоит из: шарового крана для насоса, термостатического клапана (для термостатических головок), расходомера, дренажного крана, воздушного клапана и крепления. Также входит модулирующая смесительная группа с термостатическим вентилем и группой бай-пасс с предохранительным термостатом, микрометрическим отсекающим вентилем и подключением температурного зонда.

Interasse attacco tubazioni: 277 mm.
Pipe connection center to center: 277 mm.

Cod. Sx/Left	Cod. Dx/Right	Vie/Ways	L(mm)	H(mm)	P(mm)	€
52303231GA	52313231GA	2 + 2	850	750	110	891,70
52303231GB	52313231GB	2 + 3	850	750	110	915,23
52303231GC	52313231GC	2 + 4	850	750	110	939,03
52303231GD	52313231GD	2 + 5	1000	750	110	983,15
52303231GE	52313231GE	2 + 6	1000	750	110	1005,74
52303231GF	52313231GF	2 + 7	1000	750	110	1029,74
52303231GG	52313231GG	2 + 8	1200	750	110	1073,77
52303231GH	52313231GH	2 + 9	1200	750	110	1094,27
52303231GJ	52313231GJ	2 + 10	1200	750	110	1117,79
52303231GK	52313231GK	2 + 11	1200	750	110	1141,00
52303231GL	52313231GL	2 + 12	1300	750	110	1185,80

Versione con circolatore volumetrico in Classe A
Version with Class A volumetric pump
Ausführung mit Class A Umlaufpumpe
Version avec class A pompe volumétrique
Версия с циркуляционным насосом класса A

Cod. Sx/Left	Cod. Dx/Right	Vie/Ways	L(mm)	H(mm)	P(mm)	€
52302231GA	52312231GA	2 + 2	850	750	110	790,37
52302231GB	52312231GB	2 + 3	850	750	110	813,90
52302231GC	52312231GC	2 + 4	850	750	110	837,70
52302231GD	52312231GD	2 + 5	1000	750	110	881,82
52302231GE	52312231GE	2 + 6	1000	750	110	904,41
52302231GF	52312231GF	2 + 7	1000	750	110	928,41
52302231GG	52312231GG	2 + 8	1200	750	110	972,44
52302231GH	52312231GH	2 + 9	1200	750	110	992,94
52302231GJ	52312231GJ	2 + 10	1200	750	110	1016,46
52302231GK	52312231GK	2 + 11	1200	750	110	1039,67
52302231GL	52312231GL	2 + 12	1300	750	110	1084,47

Versione con circolatore a tre velocità (solo per paesi extra CEE)
Version with 3 speed pump (only for extra CEE country)
Ausführung mit 3-Gang-Pumpe (nur für Klein CEE-Land)
Version avec pompe à 3 vitesses (uniquement pour les pays extra CEE)
Версия с трехскоростным насосом (только для стран, не входящих в ЕС)

Cod. Sx/Left	Cod. Dx/Right	Vie/Ways	L(mm)	H(mm)	P(mm)	€
52301231GA	52311231GA	2 + 2	850	750	110	668,84
52301231GB	52311231GB	2 + 3	850	750	110	692,37
52301231GC	52311231GC	2 + 4	850	750	110	716,17
52301231GD	52311231GD	2 + 5	1000	750	110	760,29
52301231GE	52311231GE	2 + 6	1000	750	110	782,88
52301231GF	52311231GF	2 + 7	1000	750	110	806,88
52301231GG	52311231GG	2 + 8	1200	750	110	850,91
52301231GH	52311231GH	2 + 9	1200	750	110	871,41
52301231GJ	52311231GJ	2 + 10	1200	750	110	894,93
52301231GK	52311231GK	2 + 11	1200	750	110	918,14
52301231GL	52311231GL	2 + 12	1300	750	110	962,94

Versione senza circolatore (con tronchetto spaziatore)
Version without pump (with pipes premounted)
Ausführung ohne Pumpe (mit Balken vormontiert)
Version sans pompe (avec des tuyaux pré-monté)
Версия без насоса (с предустановленными трубами)

IVR MULTIKLIMA 521



Interasse attacco tubazioni: 277 mm.
Pipe connection center to center: 277 mm.

Modulo di distribuzione per alta e bassa temperatura con collettori in acciaio inox AISI 304 da 1" x 3/4" EK, da 2 a 12 derivazioni; con 2 derivazioni (o 3 su richiesta) per alta temperatura; collettori completi di: valvole d'intercettazione, valvole termostattizzabili, misuratori di portata, rubinetto orientabile di carico scarico, valvola sfiato aria. Gruppo di miscelazione a punto fisso con testa termostatica e gruppo by-pass con termostato di sicurezza, detentore micrometrico e pozzetto porta sonda.

Water distribution cabinet for high and low temperature with AISI 304 stainless steel manifolds 1"x3/4" EK, 2-12 ways; with 2 ways (or 3 on demand) for high temperature; fitted with: interception valves, thermostatic valves, flow meters, rotatable drain valve and air vent. Mixing unit with fixed point with thermostatic head and by-pass group with safety thermostat, micrometric lockshield and sensor connection.

Verteilermodul für hohe und niedrige Temperatur, mit Verteilerröhren aus rostfreiem Stahl AISI 304 mit Ek Übergang 1"x3/4", mit 2-12 Abzweigungen (oder 3 auf Anfrage) für hohe Temperatur; ausgestattet mit: Absperrventilen, thermostatisierbaren Ventilen, Durchflussmessern, drehbarem Ein-/Ablassventil und Luftablassventil. Fest eingestellte Mischerguppe mit thermostatischem Kopf und Bypass-Gruppe mit Sicherheitsthermostat, mikrometrischem Regelventil und Sondenaufnahme.

Module de distribution pour haute et basse température avec collecteurs en acier inoxydable AISI304, de 1" x 3/4" EK, à 2 dérivation (ou 3 sur demande) pour température haute; pourvus de: vannes d'arrêt, vannes thermostatisables, débitmètres, robinet orientable de chargement/déchargement, vanne de purge de l'air. Groupe de mélange à point fixe avec tête thermostatique et groupe by-pass avec thermostat de sécurité, coude de réglage micrométrique et puisard porte-sonde.

Распределительный модуль для низкой и высокой температуры с коллекторами и гидравлическим сепаратором сделан из нержавеющей стали AISI 304 1" x 3/4" Евроконус, от 2 до 12 отводов, с двумя ответвлениями (с тремя - под заказ) для высокой температуры. Состоит из: шарового крана для насоса, термостатического клапана (для термостатических головок), расходомера, дренажного крана, воздушного клапана и крепления. Также входит модулирующая смесительная группа с термостатической головкой и группой бай-пасс с предохранительным термостатом, микрометрическим отсекающим вентилем и подключением температурного зонда.

Cod. Sx/Left	Cod. Dx/Right	Vie/Ways	L(mm)	H(mm)	P(mm)	€
52103230GA	52113230GA	2 + 2	850	750	110	789,86
52103230GB	52113230GB	2 + 3	850	750	110	813,39
52103230GC	52113230GC	2 + 4	850	750	110	837,19
52103230GD	52113230GD	2 + 5	1000	750	110	881,31
52103230GE	52113230GE	2 + 6	1000	750	110	903,90
52103230GF	52113230GF	2 + 7	1000	750	110	927,90
52103230GG	52113230GG	2 + 8	1200	750	110	971,93
52103230GH	52113230GH	2 + 9	1200	750	110	992,43
52103230GJ	52113230GJ	2 + 10	1200	750	110	1015,95
52103230GK	52113230GK	2 + 11	1200	750	110	1039,16
52103230GL	52113230GL	2 + 12	1300	750	110	1083,96

Versione con circolatore volumetrico in Classe A
Version with Class A volumetric pump
Ausführung mit Class A Umlaufpumpe
Version avec class A pompe volumétrique
Версия с циркуляционным насосом класса А

Cod. Sx/Left	Cod. Dx/Right	Vie/Ways	L(mm)	H(mm)	P(mm)	€
52102230GA	52112230GA	2 + 2	850	750	110	692,36
52102230GB	52112230GB	2 + 3	850	750	110	715,89
52102230GC	52112230GC	2 + 4	850	750	110	739,69
52102230GD	52112230GD	2 + 5	1000	750	110	783,81
52102230GE	52112230GE	2 + 6	1000	750	110	806,40
52102230GF	52112230GF	2 + 7	1000	750	110	830,40
52102230GG	52112230GG	2 + 8	1200	750	110	874,43
52102230GH	52112230GH	2 + 9	1200	750	110	894,93
52102230GJ	52112230GJ	2 + 10	1200	750	110	918,45
52102230GK	52112230GK	2 + 11	1200	750	110	941,66
52102230GL	52112230GL	2 + 12	1300	750	110	986,46

Versione con circolatore a tre velocità (solo per paesi extra CEE)
Version with 3 speed pump (only for extra CEE country)
Ausführung mit 3-Gang-Pumpe (nur für Klein CEE-Land)
Version avec pompe à 3 vitesses (uniquement pour les pays extra CEE)
Версия с трехскоростным насосом (только для стран, не входящих в ЕС)

Cod. Sx/Left	Cod. Dx/Right	Vie/Ways	L(mm)	H(mm)	P(mm)	€
52101230GA	52111230GA	2 + 2	850	750	110	570,83
52101230GB	52111230GB	2 + 3	850	750	110	594,36
52101230GC	52111230GC	2 + 4	850	750	110	618,16
52101230GD	52111230GD	2 + 5	1000	750	110	662,28
52101230GE	52111230GE	2 + 6	1000	750	110	684,87
52101230GF	52111230GF	2 + 7	1000	750	110	708,87
52101230GG	52111230GG	2 + 8	1200	750	110	752,90
52101230GH	52111230GH	2 + 9	1200	750	110	773,40
52101230GJ	52111230GJ	2 + 10	1200	750	110	796,92
52101230GK	52111230GK	2 + 11	1200	750	110	820,13
52101230GL	52111230GL	2 + 12	1300	750	110	864,93

Versione senza circolatore (con tronchetto spaziatore)
Version without pump (with pipes premounted)
Ausführung ohne Pumpe (mit Balken vormontiert)
Version sans pompe (avec des tuyaux prémontré)
Версия без насоса (с предустановленными трубами)

IVR MULTIKLIMA 516



Interasse attacco tubazioni: 150 mm.
 Pipe connection center to center: 150 mm.

Modulo di distribuzione per bassa temperatura, con separatore idraulico in acciaio inox, con collettori in acciaio inox AISI 304 da 1" x 3/4" EK, da 2 a 12 derivazioni; completi di: valvole d'intercettazione, valvole termostattabili, misuratori di portata, rubinetto orientabile di carico scarico, valvola sfiato aria. Gruppo di miscelazione modulante con servocomando elettrotermico, gruppo by-pass con termostato di sicurezza, detentore micrometrico e pozzetto porta sonda.

Mixing unit for low temperature with hydraulic separator, with AISI 304 stainless steel manifolds 1"x3/4" EK, 2-12 ways; fitted with: interception valves, thermostatic valves, flow meters, rotatable drain valve and air vent. Modulating mixing unit with electrothermal actuator, by-pass group with safety thermostat, micrometric lockshield and sensor connection.

Verteilermodul für niedrige Temperatur, mit hydraulischer Weiche aus rostfreiem Stahl und mit Verteilerröhren aus rostfreiem Stahl AISI 304 mit Ek Übergang 1"x3/4", mit 2-12 Abzweigungen; ausgestattet mit: Absperrventilen, thermostatisierbaren Ventilen, Durchflussmessern, drehbarem Ein-/Ablassventil und Luftablassventil. Fest eingestellte Mischerguppe mit elektrothermischer Servosteuerung, Bypass-Gruppe mit Sicherheitsthermostat, mikrometrischem Regelventil und Sondenaufnahme.

Module de distribution pour basse température avec séparateur hydraulique en acier inoxydable et avec collecteurs en acier inoxydable AISI304, de 1" x 3/4" EK, à 2-12 dérivation; pourvus de: vannes d'arrêt, vannes thermostatisables, débitmètres, robinet orientable de chargement/déchargement, vanne de purge de l'air. Groupe de mélange modulante avec servocommande électrothermique, groupe by-pass avec thermostat de sécurité, coude de réglage micrométrique, puisard porte-sonde et séparateur hydraulique en acier inoxydable.

Распределительный модуль с коллекторами и гидравлическим сепаратором из нержавеющей стали AISI 304 1" x 3/4" Евроконус, от 2 до 12 отводов для низкой температуры состоит из: шарового крана для насоса, термостатического клапана (для термостатических головок), расходомера, дренажного крана, воздушного клапана и крепления. Также входит модулирующая смесительная группа с термоэлектрическим приводом и группой бай-пасс с предохранительным термостатом, микрометрическим отсекающим вентилем и подключением температурного зонда.

Cod. Sx/Left	Cod. Dx/Right	Vie/Ways	L(mm)	H(mm)	P(mm)	€
51603232BA	51613232BA	2	850	750	110	988,56
51603232BB	51613232BB	3	850	750	110	1012,09
51603232BC	51613232BC	4	850	750	110	1035,89
51603232BD	51613232BD	5	1000	750	110	1080,01
51603232BE	51613232BE	6	1000	750	110	1102,60
51603232BF	51613232BF	7	1000	750	110	1126,60
51603232BG	51613232BG	8	1200	750	110	1170,63
51603232BH	51613232BH	9	1200	750	110	1191,13
51603232BJ	51613232BJ	10	1200	750	110	1214,65
51603232BK	51613232BK	11	1200	750	110	1237,86
51603232BL	51613232BL	12	1300	750	110	1282,66

Versione con circolatore volumetrico in Classe A
 Version with Class A volumetric pump
 Ausführung mit Class A Umlaufpumpe
 Version avec class A pompe volumétrique
 Версия с циркуляционным насосом класса A

Cod. Sx/Left	Cod. Dx/Right	Vie/Ways	L(mm)	H(mm)	P(mm)	€
51602232BA	51612232BA	2	850	750	110	891,06
51602232BB	51612232BB	3	850	750	110	914,59
51602232BC	51612232BC	4	850	750	110	938,39
51602232BD	51612232BD	5	1000	750	110	982,51
51602232BE	51612232BE	6	1000	750	110	1005,10
51602232BF	51612232BF	7	1000	750	110	1029,10
51602232BG	51612232BG	8	1200	750	110	1073,13
51602232BH	51612232BH	9	1200	750	110	1093,63
51602232BJ	51612232BJ	10	1200	750	110	1117,15
51602232BK	51612232BK	11	1200	750	110	1140,36
51602232BL	51612232BL	12	1300	750	110	1185,16

Versione con circolatore a tre velocità (solo per paesi extra CEE)
 Version with 3 speed pump (only for extra CEE country)
 Ausführung mit 3-Gang-Pumpe (nur für Klein CEE-Land)
 Version avec pompe à 3 vitesses (uniquement pour les pays extra CEE)
 Версия с трехскоростным насосом (только для стран, не входящих в ЕС)

Cod. Sx/Left	Cod. Dx/Right	Vie/Ways	L(mm)	H(mm)	P(mm)	€
51601232BA	51611232BA	2	850	750	110	769,53
51601232BB	51611232BB	3	850	750	110	793,06
51601232BC	51611232BC	4	850	750	110	816,86
51601232BD	51611232BD	5	1000	750	110	860,98
51601232BE	51611232BE	6	1000	750	110	883,57
51601232BF	51611232BF	7	1000	750	110	907,57
51601232BG	51611232BG	8	1200	750	110	951,60
51601232BH	51611232BH	9	1200	750	110	972,10
51601232BJ	51611232BJ	10	1200	750	110	995,62
51601232BK	51611232BK	11	1200	750	110	1018,83
51601232BL	51611232BL	12	1300	750	110	1063,63

Versione senza circolatore (con tronchetto spaziatore)
 Version without pump (with pipes premounted)
 Ausführung ohne Pumpe (mit Balken vormontiert)
 Version sans pompe (avec des tuyaux pré-monté)
 Версия без насоса (с предустановленными трубами)

IVR MULTIKLIMA 515



Modulo di distribuzione per bassa temperatura, con separatore idraulico in acciaio inox, con collettori in acciaio inox AISI 304 da 1" x 3/4" EK, da 2 a 12 derivazioni; completi di: valvole d'intercettazione, valvole termostattizzabili, misuratori di portata, rubinetto orientabile di carico scarico, valvola sfiato aria. Gruppo di miscelazione modulante con servocomando elettrotermico, gruppo by-pass con termostato di sicurezza, detentore micrometrico e pozzetto porta sonda.

Mixing unit for low temperature with hydraulic separator, with AISI 304 stainless steel manifolds 1"x3/4" EK, 2-12 ways; fitted with: interception valves, thermostatic valves, flow meters, rotatable drain valve and air vent. Modulating mixing unit with electrothermal actuator, by-pass group with safety thermostat, micrometric lockshield and sensor connection.

Verteilermodul für niedrige Temperatur, mit hydraulischer Weiche aus rostfreiem Stahl und mit Verteilerröhren aus rostfreiem Stahl AISI 304 mit Ek Übergang 1"x3/4", mit 2-12 Abzweigungen; ausgestattet mit: Absperrventilen, thermostatisierbaren Ventilen, Durchflussmessern, drehbarem Ein-/Ablassventil und Luftablassventil. Fest eingestellte Mischerguppe mit elektrothermischer Servosteuerung, Bypass-Gruppe mit Sicherheitsthermostat, mikrometrischem Regelventil und Sondenaufnahme.

Module de distribution pour basse température avec séparateur hydraulique en acier inoxydable et avec collecteurs en acier inoxydable AISI304, de 1" x 3/4" EK, à 2-12 dérivation; pourvus de: vannes d'arrêt, vannes thermostatisables, débitmètres, robinet orientable de chargement/déchargement, vanne de purge de l'air. Groupe de mélange modulant avec servocommande électrothermique, groupe by-pass avec thermostat de sécurité, coude de réglage micrométrique, puisard porte-sonde et séparateur hydraulique en acier inoxydable.

Распределительный модуль с коллекторами и гидравлическим сепаратором из нержавеющей стали AISI 304 1" x 3/4" Евроконус, от 2 до 12 отводов для низкой температуры состоит из: шарового крана для насоса, термостатического клапана (для термостатических головок), расходомера, дренажного крана, воздушного клапана и крепления. Также входит модулирующая смесительная группа с термоэлектрическим приводом и группой бай-пасс с предохранительным термостатом, микрометрическим отсекающим вентилем и подключением температурного зонда.

Interasse attacco tubazioni: 277 mm.
Pipe connection center to center: 277 mm.

Cod. Sx/Left	Cod. Dx/Right	Vie/Ways	L(mm)	H(mm)	P(mm)	€
51503232BA	51513232BA	2	600	750	110	784,23
51503232BB	51513232BB	3	700	750	110	815,79
51503232BC	51513232BC	4	700	750	110	839,59
51503232BD	51513232BD	5	850	750	110	873,66
51503232BE	51513232BE	6	850	750	110	896,25
51503232BF	51513232BF	7	850	750	110	920,24
51503232BG	51513232BG	8	1000	750	110	964,32
51503232BH	51513232BH	9	1000	750	110	984,81
51503232BJ	51513232BJ	10	1000	750	110	1008,34
51503232BK	51513232BK	11	1200	750	110	1051,31
51503232BL	51513232BL	12	1200	750	110	1074,32

Versione con circolatore volumetrico in Classe A
Version with Class A volumetric pump
Ausführung mit Class A Umlaufpumpe
Version avec class A pompe volumétrique
Версия с циркуляционным насосом класса А

Cod. Sx/Left	Cod. Dx/Right	Vie/Ways	L(mm)	H(mm)	P(mm)	€
51502232BA	51512232BA	2	600	750	110	686,73
51502232BB	51512232BB	3	700	750	110	718,29
51502232BC	51512232BC	4	700	750	110	742,09
51502232BD	51512232BD	5	850	750	110	776,16
51502232BE	51512232BE	6	850	750	110	798,75
51502232BF	51512232BF	7	850	750	110	822,74
51502232BG	51512232BG	8	1000	750	110	866,82
51502232BH	51512232BH	9	1000	750	110	887,31
51502232BJ	51512232BJ	10	1000	750	110	910,84
51502232BK	51512232BK	11	1200	750	110	953,81
51502232BL	51512232BL	12	1200	750	110	976,82

Versione con circolatore a tre velocità (solo per paesi extra CEE)
Version with 3 speed pump (only for extra CEE country)
Ausführung mit 3-Gang-Pumpe (nur für Klein CEE-Land)
Version avec pompe à 3 vitesses (uniquement pour les pays extra CEE)
Версия с трехскоростным насосом (только для стран, не входящих в ЕС)

Cod. Sx/Left	Cod. Dx/Right	Vie/Ways	L(mm)	H(mm)	P(mm)	€
51501232BA	51511232BA	2	600	750	110	565,20
51501232BB	51511232BB	3	700	750	110	596,76
51501232BC	51511232BC	4	700	750	110	620,56
51501232BD	51511232BD	5	850	750	110	654,63
51501232BE	51511232BE	6	850	750	110	677,22
51501232BF	51511232BF	7	850	750	110	701,21
51501232BG	51511232BG	8	1000	750	110	745,29
51501232BH	51511232BH	9	1000	750	110	765,78
51501232BJ	51511232BJ	10	1000	750	110	789,31
51501232BK	51511232BK	11	1200	750	110	832,28
51501232BL	51511232BL	12	1200	750	110	855,29

Versione senza circolatore (con tronchetto spaziatore)
Version without pump (with pipes premounted)
Ausführung ohne Pumpe (mit Balken vormontiert)
Version sans pompe (avec des tuyaux prémontré)
Версия без насоса (с предустановленными трубами)

IVR MULTIKLIMA 514



Interasse attacco tubazioni: 150 mm.
Pipe connection center to center: 150 mm.

Modulo di distribuzione per bassa temperatura, con separatore idraulico in acciaio inox, con collettori in acciaio inox AISI 304 da 1" x 3/4" EK, da 2 a 12 derivazioni; completi di: valvola d'intercettazione, valvole termostattizzabili, misuratori di portata, rubinetto orientabile di carico scarico, valvola sfiato aria. Gruppo di miscelazione a punto fisso con miscelatore termostatico, gruppo by-pass con termostato di sicurezza, detentore micrometrico e pozzetto porta sonda.

Water distribution cabinet for low temperature with stainless steel hydraulic separator and with AISI 304 stainless steel manifolds 1"x3/4" EK, 2-12 ways; fitted with: interception valve, thermostatic valves, flow meters, rotatable drain valves and air vent. Mixing unit with fixed point with thermostatic mixing valve, by-pass group with safety thermostat, micrometric lockshield and sensor connection.

Verteilermodul für niedrige Temperatur mit hydraulischer Weiche aus rostfreiem Stahl und mit Verteilerröhren aus rostfreiem Stahl AISI 304 mit Ek Übergang 1"x3/4", mit 2-12 Abzweigungen; ausgestattet mit: Absperrventil, thermostatisierbaren Ventilen, Durchflussmessern, drehbarem Ein-/Ablassventil und Luftablassventil. Fest eingestellte Mischerguppe mit thermostatischem Mischer, Bypass-Gruppe mit Sicherheitsthermostat, mikrometrischem Regelventil und Sondenaufnahme.

Module de distribution pour basse température, avec collecteurs en acier inoxydable AISI304, de 1" x 3/4" EK, à 2-12 dérivation; pourvus de: vanne d'arrêt, vannes thermostatisables, débitmètres, robinet orientable de chargement/déchargement, vanne de purge de l'air. Groupe de mélange à point fixe avec mitigeur thermostatique, groupe by-pass avec thermostat de sécurité, coude de réglage micrométrique et puisard porte-sonde, séparateur hydraulique en acier inoxydable et séparateur hydraulique en acier inoxydable.

Распределительный модуль с коллекторами и гидравлическим сепаратором из нержавеющей стали AISI 304 1" x 3/4" Евроконус, от 2 до 12 отводов для низкой температуры состоит из: шарового крана для насоса, термостатического клапана (для термостатических головок), расходомера, дренажного крана, воздушного клапана и крепления. Также входит модулирующая смесительная группа с термостатическим вентилем и группой бай-пасс с предохранительным термостатом, микрометрическим отсекающим вентилем и подключением температурного зонда.

Cod. Sx/Left	Cod. Dx/Right	Vie/Ways	L(mm)	H(mm)	P(mm)	€
51403231BA	51413231BA	2	850	750	110	1010,23
51403231BB	51413231BB	3	850	750	110	1033,76
51403231BC	51413231BC	4	850	750	110	1057,56
51403231BD	51413231BD	5	1000	750	110	1101,68
51403231BE	51413231BE	6	1000	750	110	1124,27
51403231BF	51413231BF	7	1000	750	110	1148,27
51403231BG	51413231BG	8	1200	750	110	1192,30
51403231BH	51413231BH	9	1200	750	110	1212,80
51403231BJ	51413231BJ	10	1200	750	110	1236,32
51403231BK	51413231BK	11	1200	750	110	1259,53
51403231BL	51413231BL	12	1300	750	110	1304,33

Versione con circolatore volumetrico in Classe A
Version with Class A volumetric pump
Ausführung mit Class A Umlaufpumpe
Version avec class A pompe volumétrique
Версия с циркуляционным насосом класса A

Cod. Sx/Left	Cod. Dx/Right	Vie/Ways	L(mm)	H(mm)	P(mm)	€
51402231BA	51412231BA	2	850	750	110	908,90
51402231BB	51412231BB	3	850	750	110	932,43
51402231BC	51412231BC	4	850	750	110	956,23
51402231BD	51412231BD	5	1000	750	110	1000,35
51402231BE	51412231BE	6	1000	750	110	1022,94
51402231BF	51412231BF	7	1000	750	110	1046,94
51402231BG	51412231BG	8	1200	750	110	1090,97
51402231BH	51412231BH	9	1200	750	110	1111,47
51402231BJ	51412231BJ	10	1200	750	110	1134,99
51402231BK	51412231BK	11	1200	750	110	1158,20
51402231BL	51412231BL	12	1300	750	110	1203,00

Versione con circolatore a tre velocità (solo per paesi extra CEE)
Version with 3 speed pump (only for extra CEE country)
Ausführung mit 3-Gang-Pumpe (nur für Klein CEE-Land)
Version avec pompe à 3 vitesses (uniquement pour les pays extra CEE)
Версия с трехскоростным насосом (только для стран, не входящих в ЕС)

Cod. Sx/Left	Cod. Dx/Right	Vie/Ways	L(mm)	H(mm)	P(mm)	€
51401231BA	51411231BA	2	850	750	110	787,37
51401231BB	51411231BB	3	850	750	110	810,90
51401231BC	51411231BC	4	850	750	110	834,70
51401231BD	51411231BD	5	1000	750	110	878,82
51401231BE	51411231BE	6	1000	750	110	901,41
51401231BF	51411231BF	7	1000	750	110	925,41
51401231BG	51411231BG	8	1200	750	110	969,44
51401231BH	51411231BH	9	1200	750	110	989,94
51401231BJ	51411231BJ	10	1200	750	110	1013,46
51401231BK	51411231BK	11	1200	750	110	1036,67
51401231BL	51411231BL	12	1300	750	110	1081,47

Versione senza circolatore (con tronchetto spaziatore)
Version without pump (with pipes premounted)
Ausführung ohne Pumpe (mit Balken vormontiert)
Version sans pompe (avec des tuyaux pré-monté)
Версия без насоса (с предустановленными трубами)

IVR MULTIKLIMA 513



Interasse attacco tubazioni: 277 mm.
Pipe connection center to center: 277 mm.

Modulo di distribuzione per bassa temperatura con collettori in acciaio inox AISI 304 da 1" x 3/4" EK, da 2 a 12 derivazioni; completi di: valvola d'intercettazione, valvole termostattizzabili, misuratori di portata, rubinetto orientabile di carico scarico, valvola sfiato aria. Gruppo di miscelazione a punto fisso con miscelatore termostatico, gruppo by-pass con termostato di sicurezza, detentore micrometrico e pozzetto porta sonda.

Water distribution cabinet for low temperature with AISI 304 stainless steel manifolds 1"x3/4" EK, 2-12 ways; fitted with: interception valve, thermostatic valves, flow meters, rotatable drain valves and air vent. Mixing unit with fixed point with thermostatic mixing valve, by-pass group with safety thermostat, micrometric lockshield and sensor connection.

Verteilermodul für niedrige Temperatur mit Verteilerrohren aus rostfreiem Stahl AISI 304 mit Ek Übergang 1"x3/4", mit 2-12 Abzweigungen; ausgestattet mit: Absperrventil, thermostatisierbaren Ventilen, Durchflussmessern, drehbarem Ein-/Ablassventil und Luftablassventil. Fest eingestellte Mischergruppe mit Thermostatmischer, Bypass-Gruppe mit Sicherheitsthermostat, mikrometrischem Regelventil und Sondenaufnahme.

Module de distribution pour basse température, avec collecteurs en acier inoxydable AISI304, de 1" x 3/4" EK, à 2-12 dérivation; pourvus de: vanne d'arrêt, vannes thermostatizables, débitmètres, robinet orientable de chargement/déchargement, vanne de purge de l'air. Groupe de mélange à point fixe avec mélangeur thermostatique, groupe by-pass avec thermostat de sécurité, coude de réglage micrométrique et puisard porte-sonde.

Распределительный модуль с коллекторами из нержавеющей стали AISI 304 1" x 3/4" Евроконус, от 2 до 12 отводов для низкой температуры состоит из: шарового крана для насоса, термостатического клапана (для термостатических головок), расходомера, дренажного крана, воздушного клапана и крепления. Также входит модулирующая смесительная группа с термостатическим вентилем и группой бай-пасс с предохранительным термостатом, микрометрическим отсекающим вентилем и подключением температурного зонда.

Cod. Sx/Left	Cod. Dx/Right	Vie/Ways	L(mm)	H(mm)	P(mm)	€
51303231BA	51313231BA	2	600	750	110	805,90
51303231BB	51313231BB	3	700	750	110	837,46
51303231BC	51313231BC	4	700	750	110	861,26
51303231BD	51313231BD	5	850	750	110	895,33
51303231BE	51313231BE	6	850	750	110	917,92
51303231BF	51313231BF	7	850	750	110	941,92
51303231BG	51313231BG	8	1000	750	110	985,99
51303231BH	51313231BH	9	1000	750	110	1006,48
51303231BJ	51313231BJ	10	1000	750	110	1030,01
51303231BK	51313231BK	11	1200	750	110	1072,98
51303231BL	51313231BL	12	1200	750	110	1095,99

Versione con circolatore volumetrico in Classe A
Version with Class A volumetric pump
Ausführung mit Class A Umlaufpumpe
Version avec class A pompe volumétrique
Версия с циркуляционным насосом класса А

Cod. Sx/Left	Cod. Dx/Right	Vie/Ways	L(mm)	H(mm)	P(mm)	€
51302231BA	51312231BA	2	600	750	110	704,57
51302231BB	51312231BB	3	700	750	110	736,13
51302231BC	51312231BC	4	700	750	110	759,93
51302231BD	51312231BD	5	850	750	110	794,00
51302231BE	51312231BE	6	850	750	110	816,59
51302231BF	51312231BF	7	850	750	110	840,58
51302231BG	51312231BG	8	1000	750	110	884,65
51302231BH	51312231BH	9	1000	750	110	905,15
51302231BJ	51312231BJ	10	1000	750	110	928,67
51302231BK	51312231BK	11	1200	750	110	971,64
51302231BL	51312231BL	12	1200	750	110	994,66

Versione con circolatore a tre velocità (solo per paesi extra CEE)
Version with 3 speed pump (only for extra CEE country)
Ausführung mit 3-Gang-Pumpe (nur für Klein CEE-Land)
Version avec pompe à 3 vitesses (uniquement pour les pays extra CEE)
Версия с трехскоростным насосом (только для стран, не входящих в ЕС)

Cod. Sx/Left	Cod. Dx/Right	Vie/Ways	L(mm)	H(mm)	P(mm)	€
51301231BA	51311231BA	2	600	750	110	583,04
51301231BB	51311231BB	3	700	750	110	614,60
51301231BC	51311231BC	4	700	750	110	638,40
51301231BD	51311231BD	5	850	750	110	672,47
51301231BE	51311231BE	6	850	750	110	695,06
51301231BF	51311231BF	7	850	750	110	719,05
51301231BG	51311231BG	8	1000	750	110	763,12
51301231BH	51311231BH	9	1000	750	110	783,62
51301231BJ	51311231BJ	10	1000	750	110	807,14
51301231BK	51311231BK	11	1200	750	110	850,11
51301231BL	51311231BL	12	1200	750	110	873,13

Versione senza circolatore (con tronchetto spaziatore)
Version without pump (with pipes premounted)
Ausführung ohne Pumpe (mit Balken vormontiert)
Version sans pompe (avec des tuyaux pré-monté)
Версия без насоса (с предустановленными трубами)

IVR MULTIKLIMA 512



Interasse attacco tubazioni: 150 mm.
 Pipe connection center to center: 150 mm.

Modulo di distribuzione per bassa temperatura, con separatore idraulico in acciaio inox, con collettori in acciaio inox AISI 304 da 1" x 3/4" EK, da 2 a 12 derivazioni; completi di: valvola d'intercettazione, valvole termostattabili, misuratori di portata, rubinetto orientabile di carico scarico, valvola sfiato aria. Gruppo di miscelazione a punto fisso con testa termostatica, gruppo by-pass con termostato di sicurezza, detentore micrometrico e pozzetto porta sonda.

Water distribution cabinet for low temperature with stainless steel hydraulic separator and with AISI 304 stainless steel manifolds 1"x3/4" EK, 2-12 ways; fitted with: interception valve, thermostatic valves, flow meters, rotatable drain valves and air vent. Mixing unit with fixed point with thermostatic head, by-pass group with safety thermostat, micrometric lockshield and sensor connection.

Verteilermodul für niedrige Temperatur, mit hydraulischer Weiche aus rostfreiem Stahl und mit Verteilerrohren aus rostfreiem Stahl AISI 304 mit Ek Übergang 1"x3/4", mit 2-12 Abzweigungen; ausgestattet mit: Absperrventil, thermostatisierbaren Ventilen, Durchflussmessern, drehbarem Ein-/Ablassventil und Luftablassventil. Fest eingestellte Mischerguppe mit thermostatischem Kopf, Bypass-Gruppe mit Sicherheitsthermostat, mikrometrischem Regelventil und Sondenaufnahme.

Module de distribution pour basse température, avec séparateur hydraulique en acier inoxydable et avec collecteurs en acier inoxydable AISI304, de 1" x 3/4" EK, à 2-12 dérivation; pourvus de: vannes d'arrêt, vanne thermostatisables, débitmètres, robinet orientable de chargement/déchargement, vanne de purge de l'air. Groupe de mélange à point fixe avec tête thermostatique, groupe by-pass avec thermostat de sécurité, coude de réglage micrométrique puisard porte-sonde.

Распределительный модуль с коллекторами и гидравлическим сепаратором из нержавеющей стали AISI 304 1" x 3/4" Евроконус, от 2 до 12 отводов для низкой температуры (головки), расходомера, дренажного крана, воздушного клапана и крепления. Также входит модулирующая смесительная группа с термостатической головкой и группой бай-пасс с предохранительным термостатом, микрометрическим отсекающим вентилем и подключением температурного зонда.

Cod. Sx/Left	Cod. Dx/Right	Vie/Ways	L(mm)	H(mm)	P(mm)	€
51203230BA	51213230BA	2	850	750	110	908,39
51203230BB	51213230BB	3	850	750	110	931,92
51203230BC	51213230BC	4	850	750	110	955,72
51203230BD	51213230BD	5	1000	750	110	999,84
51203230BE	51213230BE	6	1000	750	110	1022,43
51203230BF	51213230BF	7	1000	750	110	1046,43
51203230BG	51213230BG	8	1200	750	110	1090,46
51203230BH	51213230BH	9	1200	750	110	1110,96
51203230BJ	51213230BJ	10	1200	750	110	1134,48
51203230BK	51213230BK	11	1200	750	110	1157,69
51203230BL	51213230BL	12	1300	750	110	1202,49

Versione con circolatore volumetrico in Classe A
 Version with Class A volumetric pump
 Ausführung mit Class A Umlaufpumpe
 Version avec class A pompe volumétrique
 Версия с циркуляционным насосом класса A

Cod. Sx/Left	Cod. Dx/Right	Vie/Ways	L(mm)	H(mm)	P(mm)	€
51202230BA	51212230BA	2	850	750	110	810,89
51202230BB	51212230BB	3	850	750	110	834,42
51202230BC	51212230BC	4	850	750	110	858,22
51202230BD	51212230BD	5	1000	750	110	902,34
51202230BE	51212230BE	6	1000	750	110	924,93
51202230BF	51212230BF	7	1000	750	110	948,93
51202230BG	51212230BG	8	1200	750	110	992,96
51202230BH	51212230BH	9	1200	750	110	1013,46
51202230BJ	51212230BJ	10	1200	750	110	1036,98
51202230BK	51212230BK	11	1200	750	110	1060,19
51202230BL	51212230BL	12	1300	750	110	1104,99

Versione con circolatore a tre velocità (solo per paesi extra CEE)
 Version with 3 speed pump (only for extra CEE country)
 Ausführung mit 3-Gang-Pumpe (nur für Klein CEE-Land)
 Version avec pompe à 3 vitesses (uniquement pour les pays extra CEE)
 Версия с трехскоростным насосом (только для стран, не входящих в ЕС)

Cod. Sx/Left	Cod. Dx/Right	Vie/Ways	L(mm)	H(mm)	P(mm)	€
51201230BA	51211230BA	2	850	750	110	690,09
51201230BB	51211230BB	3	850	750	110	713,62
51201230BC	51211230BC	4	850	750	110	737,42
51201230BD	51211230BD	5	1000	750	110	781,54
51201230BE	51211230BE	6	1000	750	110	804,13
51201230BF	51211230BF	7	1000	750	110	828,13
51201230BG	51211230BG	8	1200	750	110	872,16
51201230BH	51211230BH	9	1200	750	110	892,66
51201230BJ	51211230BJ	10	1200	750	110	916,18
51201230BK	51211230BK	11	1200	750	110	939,39
51201230BL	51211230BL	12	1300	750	110	984,19

Versione senza circolatore (con tronchetto spaziatore)
 Version without pump (with pipes pre-mounted)
 Ausführung ohne Pumpe (mit Balken vormontiert)
 Version sans pompe (avec des tuyaux pré-monté)
 Версия без насоса (с предустановленными трубами)

IVR MULTIKLIMA 511



Modulo di distribuzione per bassa temperatura con collettori in acciaio inox AISI 304 da 1" x 3/4" EK, da 2 a 12 derivazioni; completi di: valvola d'intercettazione, valvole termostattizzabili, misuratori di portata, rubinetto orientabile di carico scarico, valvola sfiato aria. Gruppo di miscelazione a punto fisso con testa termostatica, gruppo by-pass con termostato di sicurezza, detentore micrometrico e pozzetto porta sonda.

Water distribution cabinet for low temperature with AISI 304 stainless steel manifolds 1"x3/4" EK, 2-12 ways; fitted with: interception valve, thermostatic valves, flow meters, rotatable drain valves and air vent. Mixing unit with fixed point with thermostatic head, by-pass group with safety thermostat, micrometric lockshield and sensor connection.

Verteilermodul für niedrige Temperatur mit Verteilerrohren aus rostfreiem Stahl AISI 304 mit Ek Übergang 1"x3/4", mit 2-12 Abzweigungen; ausgestattet mit: Absperrventilen, thermostatisierbaren Ventilen, Durchflussmessern, drehbarem Ein-/Ablassventil und Luftablassventil. Fest eingestellte Mischergruppe mit thermostatischem Kopf, Bypass-Gruppe mit Sicherheitsthermostat, mikrometrischem Regelventil und Sondenaufnahme.

Module de distribution pour basse température, avec collecteurs en acier inoxydable AISI304 de 1" x 3/4" EK, à 2-12 dérivation; pourvus de: vannes d'arrêt, vannes thermostatizables, débitmètres, robinet orientable de chargement/déchargement, vanne de purge de l'air. Groupe de mélange à point fixe avec tête thermostatique, groupe by-pass avec thermostat de sécurité, coude de réglage micrométrique et puisard porte-sonde.

Распределительный модуль с коллекторами из нержавеющей стали AISI 304 1" x 3/4" Евроконус, от 2 до 12 отводов для низкой температуры состоит из: шарового крана для насоса, термостатического клапана (для термостатических головок), расходомера, дренажного крана, воздушного клапана и крепления. Также входит модулирующая смесительная группа с термостатической головкой и группой бай-пасс с предохранительным термостатом, микрометрическим отсекающим вентилем и подключением температурного зонда.

Interasse attacco tubazioni: 277 mm.
Pipe connection center to center: 277 mm.

Cod. Sx/Left	Cod. Dx/Right	Vie/Ways	L(mm)	H(mm)	P(mm)	€
51103230BA	51113230BA	2	600	750	110	704,06
51103230BB	51113230BB	3	700	750	110	735,62
51103230BC	51113230BC	4	700	750	110	759,42
51103230BD	51113230BD	5	850	750	110	793,49
51103230BE	51113230BE	6	850	750	110	816,08
51103230BF	51113230BF	7	850	750	110	840,07
51103230BG	51113230BG	8	1000	750	110	884,14
51103230BH	51113230BH	9	1000	750	110	904,64
51103230BJ	51113230BJ	10	1000	750	110	928,16
51103230BK	51113230BK	11	1200	750	110	971,13
51103230BL	51113230BL	12	1200	750	110	994,15

Versione con circolatore volumetrico in Classe A
Version with Class A volumetric pump
Ausführung mit Class A Umlaufpumpe
Version avec class A pompe volumétrique
Версия с циркуляционным насосом класса А

Cod. Sx/Left	Cod. Dx/Right	Vie/Ways	L(mm)	H(mm)	P(mm)	€
51102230BA	51112230BA	2	600	750	110	606,56
51102230BB	51112230BB	3	700	750	110	638,12
51102230BC	51112230BC	4	700	750	110	661,92
51102230BD	51112230BD	5	850	750	110	695,99
51102230BE	51112230BE	6	850	750	110	718,58
51102230BF	51112230BF	7	850	750	110	742,57
51102230BG	51112230BG	8	1000	750	110	786,64
51102230BH	51112230BH	9	1000	750	110	807,14
51102230BJ	51112230BJ	10	1000	750	110	830,66
51102230BK	51112230BK	11	1200	750	110	873,63
51102230BL	51112230BL	12	1200	750	110	896,65

Versione con circolatore a tre velocità (solo per paesi extra CEE)
Version with 3 speed pump (only for extra CEE country)
Ausführung mit 3-Gang-Pumpe (nur für Klein CEE-Land)
Version avec pompe à 3 vitesses (uniquement pour les pays extra CEE)
Версия с трехскоростным насосом (только для стран, не входящих в ЕС)

Cod. Sx/Left	Cod. Dx/Right	Vie/Ways	L(mm)	H(mm)	P(mm)	€
51101230BA	51111230BA	2	600	750	110	485,76
51101230BB	51111230BB	3	700	750	110	517,32
51101230BC	51111230BC	4	700	750	110	541,12
51101230BD	51111230BD	5	850	750	110	575,19
51101230BE	51111230BE	6	850	750	110	597,78
51101230BF	51111230BF	7	850	750	110	621,77
51101230BG	51111230BG	8	1000	750	110	665,84
51101230BH	51111230BH	9	1000	750	110	686,34
51101230BJ	51111230BJ	10	1000	750	110	709,86
51101230BK	51111230BK	11	1200	750	110	752,83
51101230BL	51111230BL	12	1200	750	110	775,85

Versione senza circolatore (con tronchetto spaziatore)
Version without pump (with pipes premounted)
Ausführung ohne Pumpe (mit Balken vormontiert)
Version sans pompe (avec des tuyaux prémontré)
Версия без насоса (с предустановленными трубами)

IVR MULTIKLIMA 509/A



Interasse attacco tubazioni: 200 mm.
Pipe connection center hole distance: 200 mm.
Abstand des Rohranschlusses: 200 mm.
Entraxe des fixations: 200 mm.
Межосевое соединение : 200 mm.

Modulo di distribuzione con collettori in acciaio inox AISI 304 da 1" x 3/4" EK. Preassemblato in cassetta metallica verniciata RAL 9010, collettori completi di valvole termostattizzabili (per testa termoelettrica), rubinetto orientabile di carico scarico, valvola sfiato aria, valvole a sfera d'intercettazione, tappi e zanche. Versione con detentori micrometrici di regolazione

Water distribution cabinet includes: AISI 304 stainless steel manifolds 1" x 3/4" EK. Pre-assembled in RAL9010 plated metal cabinet, manifolds are fitted with thermostatic valves (for thermoelectric head), rotatable fill & drain valve, air vent, interception valves, caps and mounting brackets. Version with micrometric regulating lockshield

Verteilermodul mit Verteilern aus rostfreiem Stahl AISI 304 mit EK Übergang 1"x3/4". Vormontiert in einem lackiertem Metallkasten RAL 9010, Verteiler ausgestattet mit: thermostatisierbaren Ventilen (für den thermoelektrischen Kopf), dreheinstellbarem Füll- und Entleerungshahn, Luftablassventil, Absperrkugelhähnen, Kappen und Befestigungsklammern. Ausführung mit mikrometrisches Absperrventil zur Einstellung

Module de distribution avec collecteurs en acier inoxydable AISI 304, 1"x3/4" EK. Préassemblé dans un boîtier métallique verni RAL 9010, collecteurs pourvus de vanne thermostatisables (pour la tête thermoelectrique), robinet orientable de chargement/déchargement, vanne de purge de l'air, vannes d'arrêt, bouchons et plaque d'ancrage. Version avec coudes de réglages micrométriques de réglage

Распределительный модуль с коллекторами из нержавеющей стали AISI 304 1" x 3/4" Евроконус. Собранный коллекторный модуль вмонтирован в металлический шкаф, окрашенный RAL 9010. Состоит из: термостатических клапанов(для термостатических головок), дренажного клапана, воздушного клапана, шаровых кранов, заглушек и креплений. Данная версия с отсекающими микрометрическими клапанами.

Cod. Sx/Left	Cod. Dx/Right	Vie/Ways	L(mm)	H(mm)	P(mm)	€
50900200AA	50910200AA	2	400	630	90	220,67
50900200AB	50910200AB	3	500	630	90	245,00
50900200AC	50910200AC	4	500	630	90	263,18
50900200AD	50910200AD	5	600	630	90	294,47
50900200AE	50910200AE	6	600	630	90	312,53
50900200AF	50910200AF	7	700	630	90	338,99
50900200AG	50910200AG	8	700	630	90	357,21
50900200AH	50910200AH	9	850	630	90	397,35
50900200AJ	50910200AJ	10	850	630	90	415,27
50900200AK	50910200AK	11	850	630	90	433,26
50900200AL	50910200AL	12	1000	630	90	470,82

IVR MULTIKLIMA 509/B



Interasse attacco tubazioni: 200 mm.
Pipe connection center hole distance: 200 mm.
Abstand des Rohranschlusses: 200 mm.
Entraxe des fixations: 200 mm.
Межосевое соединение : 200 mm.

Modulo di distribuzione con collettori in acciaio inox AISI 304 da 1" x 3/4" EK. Preassemblato in cassetta metallica verniciata RAL 9010, collettori completi di valvole termostattizzabili (per testa termoelettrica), rubinetto orientabile di carico scarico, valvola sfiato aria, valvole a sfera d'intercettazione, tappi e zanche. Versione con misuratori di portata

Water distribution cabinet includes: AISI 304 stainless steel manifolds 1" x 3/4" EK. Pre-assembled in RAL9010 plated metal cabinet, manifolds are fitted with thermostatic valves (for thermoelectric head), rotatable fill & drain valve, air vent, interception valves, caps and mounting brackets. Version with flowmeter

Verteilermodul mit Verteilern aus rostfreiem Stahl AISI 304 mit EK Übergang 1"x3/4". Vormontiert in einem lackiertem Metallkasten RAL 9010, Verteiler ausgestattet mit: thermostatisierbaren Ventilen (für den thermoelektrischen Kopf), dreheinstellbarem Füll- und Entleerungshahn, Luftablassventil, Absperrkugelhähnen, Kappen und Befestigungsklammern. Ausführung mit Durchflussmesser

Module de distribution avec collecteurs en acier inoxydable AISI 304, 1"x3/4" EK. Préassemblé dans un boîtier métallique verni RAL 9010, collecteurs pourvus de vanne thermostatisables (pour la tête thermoelectrique), robinet orientable de chargement/déchargement, vanne de purge de l'air, vannes d'arrêt, bouchons et plaque d'ancrage. Version avec mesureurs de débit

Распределительный модуль с коллекторами из нержавеющей стали AISI 304 1" x 3/4" Евроконус. Собранный коллекторный модуль вмонтирован в металлический шкаф, окрашенный RAL 9010. Состоит из: термостатических клапанов(для термостатических головок), дренажного клапана, воздушного клапана, шаровых кранов, заглушек и креплений. Данная версия с расходомерами

Cod. Sx/Left	Cod. Dx/Right	Vie/Ways	L(mm)	H(mm)	P(mm)	€
50900200BA	50910200BA	2	400	630	90	231,23
50900200BB	50910200BB	3	500	630	90	260,80
50900200BC	50910200BC	4	500	630	90	284,60
50900200BD	50910200BD	5	600	630	90	321,43
50900200BE	50910200BE	6	600	630	90	344,37
50900200BF	50910200BF	7	700	630	90	376,32
50900200BG	50910200BG	8	700	630	90	399,77
50900200BH	50910200BH	9	850	630	90	445,12
50900200BJ	50910200BJ	10	850	630	90	468,64
50900200BK	50910200BK	11	850	630	90	491,79
50900200BL	50910200BL	12	1000	630	90	534,51

IVR MULTIKLIMA

Gruppi di miscelazione / Mixing units



IVR 711



IVR 711/A
Circolatore classe "A"
RS25/6-RKA M Wilo
Cod. 171115007



IVR 711/C
Circolatore a 3 velocità
NYL33-25 P Salmson
Cod. 171115001



IVR 711/S
Senza Circolatore
Cod. 171115000

Gruppo di miscelazione a punto fisso con testa termostatica

Fixed point mixing unit with thermostatic head

Fest eingestellte Mischgruppe mit Thermostatkopf

Groupe de mélange à point fixe avec tête thermostatique

Смесительная группа с фиксированной точкой и термостатической головкой IVR.

Cod./Code	Misura/Size	□/田	€
171115007	3/4" x 1"	1	323,81
171115001	3/4" x 1"	1	226,31
171115000	3/4" x 1"	1	105,51

IVR 712



IVR 712/A
Circolatore classe "A"
RS25/6-RKA M Wilo
Cod. 171215007



IVR 712/C
Circolatore a 3 velocità
NYL33-25 P Salmson
Cod. 171215001



IVR 712/S
Senza Circolatore
Cod. 171215000

Gruppo di miscelazione a punto fisso con miscelatore termostatico

Fixed point mixing unit with thermostatic mixing valve

Fest eingestellte Mischgruppe mit thermostatischer Mischer

Groupe de mélange à point fixe avec mitigeur thermostatique

Смесительная группа с фиксированной точкой и термостатическим смесителем.

Cod./Code	Misura/Size	□/田	€
171215007	3/4" x 1"	1	427,08
171215001	3/4" x 1"	1	325,74
171215000	3/4" x 1"	1	204,21

IVR 713



IVR 713/A
Circolatore classe "A"
RS25/6-RKA M Wilo
Cod. 171315007



IVR 713/C
Circolatore a 3 velocità
NYL33-25 P Salmson
Cod. 171315001



IVR 713/S
Senza Circolatore
Cod. 171315000

Gruppo di miscelazione modulante con servocomando elettronico

Modulating mixing unit with electronic actuator

Modulierende Mischgruppe mit elektrothermischer Servosteuerung

Groupe de mélange modulant avec servocommande électrothermique

Смесительная группа с электротермическим приводом.

Cod./Code	Misura/Size	□/田	€
171315007	3/4" x 1"	1	403,98
171315001	3/4" x 1"	1	306,48
171315000	3/4" x 1"	1	184,95

IVR 714



Gruppo by-pass con valvola di regolazione micrometrica e termostato di sicurezza (taratura 50° C)
 By-pass unit with micrometric regulating valve and safety thermostat (set at 50° C).
 Bypass-Gruppe mit mikrometrischem Einstellventil und Sicherheitsthermostat (eingestellt um 50°)
 Groupe by-pass avec vanne de réglage micrométrique et thermostat de sécurité (réglé à 50° C)
 Группа бай-пасс с регулирующим микрометрическим клапаном и предохранительным термостатом(калибровка 50° C)

Cod./Code	Misura/Size	L	□/田	€
171410501	1"	277	1	92,49

Senza termostato di sicurezza
 Without safety thermostat

Cod./Code	Misura/Size	L	□/田	€
171410502	1"	277	1	64,27

IVR 714/R



Raccordo 3 pezzi portasonda per gruppi di miscela IVR 711
 Three-piece sensor connection for mixing units IVR 711
 Dreiteiliger Anschluss für Mischerguppen IVR 711
 Raccord à trois pièces pour groupes de mélange IVR 711
 Трехсоставной фитинг для смесительной группы IVR 711

Cod./Code	Misura/Size	□/田	€
171431001	1"	8/48	17,75

IVR 330



Separatore idraulico in acciaio inox aisi 304 completo di raccordi
 Hydraulic separator in stainless steel AISI 304 with unions
 Hydraulische Weiche aus rostfreiem Stahl AISI 304 mit Anschlüssen
 Séparateur hydraulique en acier inoxydable AISI 304 avec raccords
 Гидравлический сепаратор из нержавеющей стали AISI 304 в комплекте с фитингами

Cod./Code	Misura/Size	□/田	€
133027701	1" M x 1" F	1/1	180,17

IVR 330/C



Guscio di coibentazione per separatore idraulico
 Isolation for hydraulic separator
 Isolierung für hydraulische Weiche
 Isolation pour le séparateur hydraulique
 Изоляция для гидравлического сепаратора

Cod./Code	Misura/Size	□/田	€
335800420		1/1	23,90

IVR 591 - TESTA TERMOSTATICA SUNNY SONDA IMMERSIONE



Testa termostatica con sensore a liquido a bassa inerzia termica - con sonda ad immersione
Thermostatic head with liquid sensor at low thermal inertia - with sensor immersion sleeve
Thermostatkopf mit Flüssigkeitssensor mit geringer thermischen Trägheit - mit Tauchsonde
Tête thermostatique avec capteur à liquide à faible inertie thermique - avec sonde à immersion
Термостатическая головка с жидкостным сенсором, низкой термоинерцией и погружным датчиком

Cod./Code	Misura/Size	□/田	€
159100001	M30 x 1,5	1/20	21,14

IVR 331 - SERVOCOMANDO 0-10 24V NC



Servocomando 0-10 24V NC
Actuator 0-10 24 V NC (normally closed position)
Servosteuerung 0-10 24V (normalerweise geschlossen)
Servocommande 0-10 24V (normalement fermé)
Сервопривод 0-10 24V NC (нормально закрытый)

Cod./Code	Misura/Size	□/田	€
1331AXS122	M30 x 1,5	4/16	87,30

IVR 332 - TERMOSTATO DI SICUREZZA



Termostato di sicurezza
Safety thermostat
Sicherheitsthermostat
Thermostat de sécurité
Предохранительный термостат

Cod./Code	Misura/Size	T°	□/田	€
133205640	1/2"	40°	8/120	31,64
133205650	1/2"	50°	8/120	32,76



COLLETTORI / MANIFOLDS

Collettori Inox / Inox Manifolds
GLOBO

IVR 982/A - 982/B



Valvola a sfera a passaggio totale con bocchettone - attacchi M/F, sede conica, con autotenuta
Full bore ball valve with tail piece - M/F, with conical seat and auto-sealing
Kugelhahn mit vollem Durchgang und Rohrverschraubung - AG/IG, mit Kugelsitz und Selbstdichtung
Vanne à boisseau sphérique à passage intégral avec raccord - M/F, avec siège conique et auto-étanche
Полнопроходной шаровой кран со штоном и накидной гайкой - соединения Н/В, с коническим седлом и герметичной прокладкой

Cod./Code	Misura/Size	□/田	€
198205058	1/2" x 1/2" Red	10/60	7,80
198205061	1/2" x 1/2" Blue	10/60	7,80
198207078	3/4" x 3/4" Red	10/60	11,66
198207081	3/4" x 3/4" Blue	10/60	11,66
198207108	3/4" x 1" Red	10/60	13,26
198207111	3/4" x 1" Blue	10/60	13,26
198210108	1" x 1" Red	10/40	19,93
198210111	1" x 1" Blue	10/40	19,93

IVR 206/A - 206/B



Valvola a sfera a passaggio totale con dado folle - attacchi F/F, sede piana
Full bore ball valve with crazy nut - F/F, with flat seat
Kugelhahn mit vollem Durchgang und verrückter Nuss - IG/IG, mit Flachsitz
Vanne à boisseau sphérique à passage intégral avec écrou fou - F/F, avec siège plate
Полнопроходной шаровой кран с накидной гайкой - соединения В/В, с плоским седлом

Cod./Code	Misura/Size	□/田	€
120605108	1/2" x 3/4" Red	10/60	9,56
120605111	1/2" x 3/4" Blue	10/60	9,56
120607078	3/4" x 3/4" Red	10/60	9,66
120607081	3/4" x 3/4" Blue	10/60	9,66
120607208	3/4" x 1" Red	10/40	12,19
120607211	3/4" x 1" Blue	10/40	12,19

Cod./Code	Misura/Size	□/田	€
196410008	1" x 1" Red	10/40	19,14
196410211	1" x 1" Blue	10/40	19,14

IVR 205/A - 205/B



Valvola a sfera a passaggio totale con dado folle - attacchi M/F, sede piana
Full bore ball valve with crazy nut - M/F, with flat seat
Kugelhahn mit vollem Durchgang und verrückter Nuss - AG/IG, mit Flachsitz
Vanne à boisseau sphérique à passage intégral avec écrou fou - M/F, avec siège plate
Полнопроходной шаровой кран с накидной гайкой - соединения Н/В, с плоским седлом

Cod./Code	Misura/Size	□/田	€
120505077	1/2" x 3/4" RED	10/40	9,37
120505211	1/2" x 3/4" BLU	10/40	9,37
120507208	3/4" x 1" RED	10/40	12,73
120507211	3/4" x 1" BLU	10/40	12,73

IVR 980/A - 980/B



Valvola a sfera a passaggio totale con bocchettone - attacchi M/F, sede piana, con autotenuta
Full bore ball valve with tail piece - M/F, with flat seat and auto-sealing
Kugelhahn mit vollem Durchgang und Rohrverschraubung - AG/IG, mit Flachem Sitz und Selbstdichtung
Vanne à boisseau sphérique à passage intégral avec raccord - M/F, avec siège plate et auto-étanche
Полнопроходной шаровой кран со сгоном и накидной гайкой – соединения Н/В с плоским седлом и герметичной прокладкой

Cod./Code	Misura/Size	□/田	€
198010008	1" x 1" Red	10/40	19,53
198010211	1" x 1" Blue	10/40	19,53
198012008	1"1/4 x 1"1/4 Red	8/32	35,90
198012211	1"1/4 x 1"1/4 Blue	8/32	35,90

- NOTA: DISPONIBILE CON FILETTATURA NPT: ultime due cifre del codice sono "16"
- NOTE: AVAILABLE WITH THREADED END NPT: last two digits of code is "16"
- ANMERKUNG: ERHÄLTICH MIT NPT-GEWINDE: die letzten beiden Ziffern der Artikelnummer sind "16"
- NOTE: DISPONIBLE AVEC FILETAGE NPT: les deux derniers chiffres du code sont "16"
- ПРИМЕЧАНИЕ: ДОСТУПНО С РЕЗЬБОЙ NPT: две последние цифры кода "16"

IVR 981/A - 981/B



Valvola a sfera a passaggio totale a squadra con bocchettone - attacchi M/F, sede piana, con autotenuta
Angle full bore ball valve with tail piece - M/F, with flat seat and auto-sealing
Kugelhahn mit vollem Durchgang, eckförmig, Rohrverschraubung - AG/IG, mit Flachem Sitz und Selbstdichtung
Vanne à boisseau sphérique à passage intégral à équerre avec raccord - M/F, avec siège plate et auto-étanche
Полнопроходной угловой шаровой кран со сгоном и накидной гайкой – соединения Н/В с плоским седлом и герметичной прокладкой

Cod./Code	Misura/Size	□/田	€
198110008	1" x 1" Red	10/40	24,76
198110211	1" x 1" Blue	10/40	24,76

IVR 827/A - IVR 827/B



Maniglia farfalla rossa - Maniglia farfalla blu, sede piana
Red butterfly handle - Blue butterfly handle, flat seat
Rot und/oder Blau Flügelgriff mit flachem Sitz
Poignée papillon rouge - poignée papillon bleu avec siège plate
Красная ручка-бабочка - Синяя ручка-бабочка, плоское седло.

Cod./Code	Misura/Size	□/田	€
182707002	Red 3/4" x 1"	10/60	7,60
182707011	Blue 3/4" x 1"	10/60	7,60



COLLETTORI / MANIFOLDS

Collettori Inox / Inox Manifolds
 GLOBO TERMOMETRO



Valvola a sfera M/F, attacco termometro, bocchettone autotenuta, nichelata. Per AVANT FLOOR
 Ball valve M/F with thermometer, auto seal tailpiece, nickel plated. For AVANT FLOOR
 Kugelhahn AG x IG mit Innen- und Außengewinde, Thermometeranschluss, selbstdichtendem Stutzen, vernickelt - für AVANT FLOOR
 Vanne à boisseau sphérique M/F, fixation thermomètre, raccord autoétanche, nickelée - pour AVANT FLOOR
 Шаровой никелированный кран с термометром, сгоном, самогерметизирующейся прокладкой, соединение - Н/В, для AVANT FLOOR

IVR 979/A - 979/B



Maniglia farfalla rossa / blu e attacco sonda per temperatura. Sede conica
 Red/blue butterfly handle and sensor connection. Conical seat
 Roter/blauer Flügelgriff und Anschluss für Temperatursonde mit Kugelsitz.
 Poignée papillon rouge/bleu et fixation sonde pour température
 Красная/синяя ручка-бабочка и соединение для температурного зонда .С коническим седлом

Cod./Code	Misura/Size		□/田	€
197910008	1" x 1" Red	M10 x 1	10/40	32,91
197910211	1" x 1" Blue	M10 x 1	10/40	32,91

IVR 820



Termometro con guaina completo per IVR 979/A - IVR 979/B
 Thermometer with pocket for IVR 979/A - IVR 979/B
 Thermometer mit Hülle für IVR 979/A - IVR 979/B
 Thermomètre avec gaine complète pour IVR 978/A - IVR 978/B - IVR 979/A - IVR 979/B
 Термометр с кожухом для IVR 979/A - IVR 979/B

Cod./Code	Misura/Size	□/田	€
182003001	3/8" - Ø 41	10/150	7,76



Valvola a sfera a passaggio totale - con portasonda
Full bore ball valve with sensor connection
Kugelhahn mit vollem Durchgang mit Anschluss für Temperatursonde
Vanne à sphère à passage total avec fixation sonde pour température
Полнопроходной шаровой кран с соединением для датчика температуры

IVR 954 S



Attacchi F/F
Threaded ends F/F
Alle IG/IG
Fixations F/F
Соединения - В/В

Cod./Code	Misura/Size		□/⊕	€
195405711	1/2"	M10 x 1	20/80	7,37
195407711	3/4"	M10 x 1	12/48	9,29
195410711	1"	M10 x 1	12/48	15,01

IVR 944/AS



Con bocchettone autotenuta. Sede conica M/F
Auto seal tailpiece. Conical seat M/F
Mit Selbstdichtung. Kegelsitz AG/IG
Avec raccord avec auto-étanche M/F
Со сгоном и самогерметизирующейся прокладкой. С коническим седлом Н/В

Cod./Code	Misura/Size		□/⊕	€
194407078	3/4" x 3/4"	M10 x 1	10/40	17,45
194407108	3/4" x 1"	M10 x 1	10/40	18,78
194410108	1" x 1"	M10 x 1	10/40	23,81



COLLETTORI / MANIFOLDS

Testa termoelettrica / Thermo-electric actuator



Testa termoelettrica fornita nella versione NC (normalmente chiusa) o NO (normalmente aperta) per AVANT FLOOR
Thermo-electric actuator, version NC (normally closed position) or NO (normally open position) for AVANT FLOOR
Thermoelektrischer Kopf, erhältlich in den Ausführungen NC (normalerweise geschlossen) - NO (normalerweise geöffnet) - für AVANT
Tête thermoélectrique fournie dans la version NC (normalement fermée) - NO (normalement ouverte) AVANT FLOOR
Термоэлектропривод, NC (нормально закрытый) или NO (нормально открытый) для AVANT FLOOR

IVR 823



Testa termoelettrica fornita nella versione NC (normalmente chiusa) o NO (normalmente aperta) per AVANT FLOOR - 230 V

Thermo-electric actuator, version NC (normally closed position) or NO (normally open position) for AVANT FLOOR - 230 V

Thermoelektrischer Kopf, erhältlich in den Ausführungen NC (normalerweise geschlossen) - NO (normalerweise geöffnet) - für AVANT FLOOR 230 V

Tête thermoélectrique fournie dans la version NC (normalement fermée) - NO (normalement ouverte) AVANT FLOOR - 230 V

Термоэлектропривод, NC (нормально закрытый) или NO (нормально открытый) для коллекторов AVANT FLOOR - 230 V

Cod./Code	Misura/Size	□/田	€
182300101	230V NC	1/10	25,88
182300110	230V NO	1/10	25,88

Con microinterruttore ausiliario / With auxiliary microswitch / Mit Mikroschalter
Avec contact auxiliaire / С дополнительным микро-переключателем

Cod./Code	Misura/Size	□/田	€
182300140	230V NC	1/24	33,98

IVR 824



Testa termoelettrica fornita nella versione NC (normalmente chiusa) o NO (normalmente aperta) per AVANT FLOOR - 24 V

Thermo-electric actuator, version NC (normally closed position) or NO (normally open position) for AVANT FLOOR - 24 V

Thermoelektrischer Kopf, erhältlich in den Ausführungen NC (normalerweise geschlossen) - NO (normalerweise geöffnet) - für AVANT FLOOR - 24 V

Tête thermoélectrique fournie dans la version NC (normalement fermée) - NO (normalement ouverte) AVANT FLOOR - 24 V

Термоэлектропривод, NC (нормально закрытый) или NO (нормально открытый) для коллекторов AVANT FLOOR - 24 V

Cod./Code	Misura/Size	□/田	€
182400101	24V NC	1/10	25,88
182400110	24V NO	1/10	25,88

Con microinterruttore ausiliario / With auxiliary microswitch / Mit Hilfs-Mikroschalter
Avec contact auxiliaire / С дополнительным микро-переключателем

Cod./Code	Misura/Size	□/田	€
182400140	24V NC	1/24	37,88



Accessori per AVANT FLOOR
Accessories for AVANT FLOOR
Zubehöre für AVANT FLOOR
accessoire pour AVANT FLOOR
аксессуары для коллектора AVANT FLOOR

COLLETTORI / MANIFOLDS

Collettori Inox / Inox Manifolds
AVANT ACCESSORIES



IVR 825



Termostato ambiente a parete 230 V
Room thermostat 230 V
Raumthermostat als Wandausführung 230 V
Thermostat ambiant mural 230 V
Настенный термостат для жилых помещений 230 V

Cod./Code	Misura/Size	□/田	€
182500001	230V	1/50	13,69

IVR 821

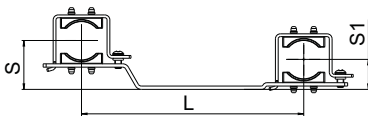

Set di 2 zanche doppie di fissaggio antivibrazione per AVANT FLOOR
Set of 2 double insulated vibration-free mounting bracket for AVANT FLOOR
Garnitur mit 2 doppelten schwingungsdämpfenden Befestigungsklammern für AVANT FLOOR
Kit de 2 doubles plaques d'ancrage antivibration pour AVANT FLOOR
Комплект из двух двойных антивибрационных кронштейнов для AVANT FLOOR

Cod./Code	Misura/Size	S(mm)	L(mm)	S1(mm)	□/田	€
182100030	1"	44	200	27	1/50	7,07
182100032	1*1/4	49	200	32	1/20	7,67

IVR 840

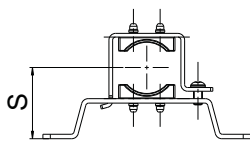

Set di 2 zanche singole di fissaggio antivibrazione per AVANT FLOOR
Set of 2 single insulating vibration-free mounting bracket for AVANT FLOOR
Garnitur mit 2 einzigen schwingungsdämpfenden Befestigungsklammern für AVANT FLOOR
Kit de 2 plaques simples d'ancrage antivibration pour AVANT FLOOR
Комплект из двух отдельных антивибрационных кронштейнов для AVANT FLOOR

Cod./Code	Misura/Size	S(mm)	L(mm)	S1(mm)	□/田	€
184010050	1"	48		20/80		5,04
184012050	1*1/4	50		20/80		4,14

Cod./Code	Misura/Size	S(mm)	L(mm)	S1(mm)	□/田	€
184010052	1"	83		20/80		5,00
184012052	1*1/4	85		20/80		5,00

IVR 404



Raccordo sdoppiatore Y per AVANT FLOOR
 Y junction splitter for AVANT FLOOR
 Y-Verteiler Splitter für AVANT FLOOR
 Y jonction séparateur pour AVANT FLOOR
 Y - разделитель потока для AVANT FLOOR

Cod./Code	Misura/Size	Attacco/Connection	□/田	€
140407001	3/4" EK	3/4" EK	10/60	11,93

IVR 408 K



Per IVR 802 - IVR 804
 For IVR 802 - IVR 804
IVR 408/1 K



Per IVR 803 - IVR 805
 For IVR 803 - IVR 805
IVR 408/2 K



Per IVR 800 - IVR 806
 For IVR 800 - IVR 806
IVR 408/3 K



Per IVR 801 - IVR 807
 For IVR 801 - IVR 807
IVR 408/4 K



Per tutti i collettori AVANT FLOOR/
 For all AVANT FLOOR manifolds
IVR 408/5 K



Per tutti i collettori AVANT FLOOR/
 For all AVANT FLOOR manifolds
IVR 408/6 K



Per tutti i collettori AVANT FLOOR/
 For all AVANT FLOOR manifolds
IVR 408/7 K

Kit estensione per AVANT FLOOR
 Extension Kit for AVANT FLOOR
 Extension Kit für AVANT FLOOR
 Kit d'extension pour AVANT FLOOR
 Дополнительный комплект для AVANT FLOOR

Cod./Code	Modello/Model AvantFloor	Vie/Ways	Misura/Size	□/田	€
140820571	IVR 408/1 K	1	1"	1/18	29,31
140820576	IVR 408/2 K	1	1"	1/18	30,10
140820580	IVR 408/3 K	1	1"	1/24	24,03
140820581	IVR 408/4 K	1	1"	1/24	24,82
140820590	IVR 408/5 K	1	1"	1/24	24,38
140820591	IVR 408/6 K	1	1"	1/18	35,89
140820592	IVR 408/7 K	1	1"	1/12	30,11

IVR 822



Etichette autoadesive
 Stickers
 Klebeetiketten
 Étiquettes autocollantes
 Стикеры

Cod./Code	Tipo/Type	□/田	€
182200001	IVR 822	100/1200	0,44

IVR 847 A



Guscio isolante aperto 12 uscite superiori ed inferiori per AVANT FLOOR
Open insulating shell with upper and lower 12 ways for AVANT FLOOR
Geöffnete Isolierhülse mit 12 oberen und unteren Ausgängen für Verteiler AVANT FLOOR
Coque isolante ouverte pour 12 sorties inférieures et supérieures pour AVANT FLOOR
Изоляция 12 верхних и нижних выходов для коллекторов AVANT FLOOR

Cod./Code	Misura/Size	□/田	€
1847A1012	1"	10	10,05
1847A1212	1"1/4	10	10,05

IVR 847 C



Guscio isolante chiuso 12 uscite inferiori per AVANT FLOOR
Closed insulating shell with 12 lower ways for AVANT FLOOR
Geschlossene Isolierhülse mit 12 unteren Ausgängen für Verteiler AVANT FLOOR
Coque isolante "fermée" pour 12 sorties inférieures pour AVANT FLOOR
Изоляция "Закрытая" 12 нижних выходов для коллекторов AVANT FLOOR

Cod./Code	Misura/Size	□/田	€
1847C1012	1"	10	10,05
1847C1212	1"1/4	10	10,05

IVR 897



Termometro a contatto per AVANT FLOOR
Contact thermometer for AVANT FLOOR
Kontaktthermometer für AVANT FLOOR
Thermomètre à contact pour AVANT FLOOR
Контактный термометр для коллекторов AVANT FLOOR

Cod./Code	Øe	□/田	€
189700010	40	10/120	7,43

COLLETTORI / MANIFOLDS

Collettori Industriali / Industrial Manifolds IVR INOX

Collettore Industriale in acciaio inox AISI 304 1"1/2 - 2", interasse 70 mm., rubinetto carico/scarico acqua (adattatore da 1"), trattamento di elettrolucidatura

Stainless steel AISI 304 Industrial Manifold 1"1/2 - 2", center hole distance 70 mm., draining valve (adapter connection 1"), electro-polished treatment

Industrie-Verteiler aus rostfreiem Edelstahl AISI 304 1"1/2"- 2" - Abstand 70 mm. Füll-Entleerungshahn (1" Zwischenstück / Adapter), Elektropoliturbehandlung

Collecteur Industriel en acier inox AISI 304 1"1/2 - 2", avec vanne à boisseau sphérique de sectionnement (adaptateur 1") robinet purge et chargement, traitement d'électropolissage

Индустриальный коллектор из нержавеющей стали AISI 304, диаметр 1"1/2 - 2", межосевое расстояние 70мм, дренажный кран (адаптер 1"), электрополировка

IVR 882

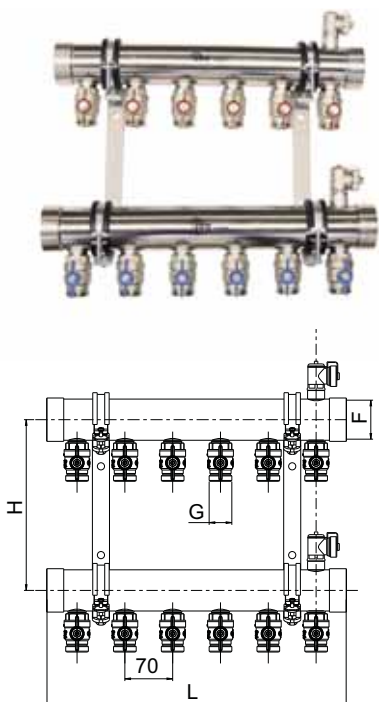

Con valvola a sfera d'intercettazione

With interception valve

Mit Absperrventil

Avec vanne à boisseau sphérique de sectionnement

С шаровым краном перехвата

Cod./Code	(F) Misura/Size	(G) Attacco/Connection	Vie/Ways	L(mm)	H(mm)	□/田	€
188242704	1"1/2	1"	4	291	250	1	250,04
188242705	1"1/2	1"	5	361	250	1	281,33
188242706	1"1/2	1"	6	431	250	1	318,89
188242707	1"1/2	1"	7	501	250	1	355,98
188242708	1"1/2	1"	8	571	250	1	392,90
188242709	1"1/2	1"	9	641	250	1	433,73
188242710	1"1/2	1"	10	711	250	1	478,15
188242711	1"1/2	1"	11	781	250	1	519,99
188242712	1"1/2	1"	12	851	250	1	561,88
188242713	1"1/2	1"	13	921	250	1	602,55
188242714	1"1/2	1"	14	991	250	1	643,23
188252704	2"	1"	4	299	250	1	273,57
188252705	2"	1"	5	369	250	1	312,37
188252706	2"	1"	6	439	250	1	359,30
188252707	2"	1"	7	509	250	1	388,14
188252708	2"	1"	8	579	250	1	426,94
188252709	2"	1"	9	649	250	1	473,76
188252710	2"	1"	10	719	250	1	526,80
188252711	2"	1"	11	789	250	1	560,78
188252712	2"	1"	12	859	250	1	604,92
188252713	2"	1"	13	929	250	1	617,84
188252714	2"	1"	14	999	250	1	682,51

IVR 883

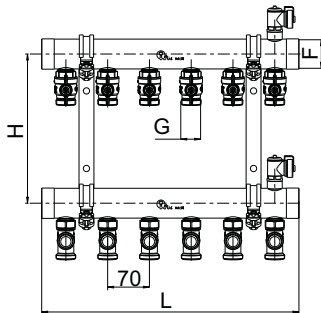

Con valvola a sfera d'intercettazione e detentore micrometrico
With interception valve and micrometric lockshield
Mit Absperrventil und mikrometrischer Rücklaufverschraubung
Avec vanne à boisseau sphérique de sectionnement et coude de réglage micrométriques
С шаровым краном перехвата

Cod./Code	(F) Misura/Size	(G) Attacco/Connection	Vie/Ways	L(mm)	H(mm)	□/田	€
188342704	1"1/2	1"	4	291	250	1	248,19
188342705	1"1/2	1"	5	361	250	1	279,02
188342706	1"1/2	1"	6	431	250	1	316,12
188342707	1"1/2	1"	7	501	250	1	352,75
188342708	1"1/2	1"	8	571	250	1	389,21
188342709	1"1/2	1"	9	641	250	1	429,57
188342710	1"1/2	1"	10	711	250	1	473,53
188342711	1"1/2	1"	11	781	250	1	514,91
188342712	1"1/2	1"	12	851	250	1	556,34
188342713	1"1/2	1"	13	921	250	1	596,55
188342714	1"1/2	1"	14	991	250	1	636,76
188352704	2"	1"	4	299	250	1	271,72
188352705	2"	1"	5	369	250	1	310,06
188352706	2"	1"	6	439	250	1	356,53
188352707	2"	1"	7	509	250	1	384,91
188352708	2"	1"	8	579	250	1	423,24
188352709	2"	1"	9	649	250	1	469,60
188352710	2"	1"	10	719	250	1	522,18
188352711	2"	1"	11	789	250	1	555,69
188352712	2"	1"	12	859	250	1	599,37
188352713	2"	1"	13	929	250	1	611,83
188352714	2"	1"	14	999	250	1	676,04

IVR 884

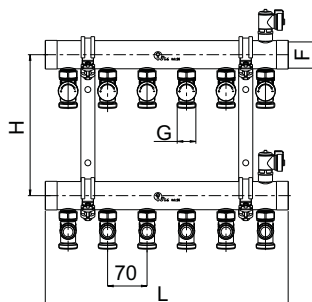

Con valvola termostattizzabile, cappello di regolazione, detentore micrometrico
With thermostatic valve, operating plastic cap and micrometric lockshield
Mit thermostatisierbarem Ventil, Einstellkappe und mikrometrischer Rücklaufverschraubung
Avec vanne thermostatizable, chapeau de réglage et coude de réglage micrométrique
С термостатическим клапаном, регулирующим колпачком и отсекающим клапаном

Cod./Code	(F) Misura/Size	(G) Attacco/Connection	Vie/Ways	L(mm)	H(mm)	□/田	€
188442704	1"1/2	1"	4	291	250	1	252,71
188442705	1"1/2	1"	5	361	250	1	284,68
188442706	1"1/2	1"	6	431	250	1	322,91
188442707	1"1/2	1"	7	501	250	1	360,66
188442708	1"1/2	1"	8	571	250	1	398,25
188442709	1"1/2	1"	9	641	250	1	439,74
188442710	1"1/2	1"	10	711	250	1	484,83
188442711	1"1/2	1"	11	781	250	1	527,35
188442712	1"1/2	1"	12	851	250	1	569,91
188442713	1"1/2	1"	13	921	250	1	611,25
188442714	1"1/2	1"	14	991	250	1	652,59
188452704	2"	1"	4	299	250	1	276,24
188452705	2"	1"	5	369	250	1	315,71
188452706	2"	1"	6	439	250	1	363,31
188452707	2"	1"	7	509	250	1	392,82
188452708	2"	1"	8	579	250	1	432,29
188452709	2"	1"	9	649	250	1	479,78
188452710	2"	1"	10	719	250	1	533,49
188452711	2"	1"	11	789	250	1	568,13
188452712	2"	1"	12	859	250	1	612,94
188452713	2"	1"	13	929	250	1	626,53
188452714	2"	1"	14	999	250	1	691,87

COLLETTORI / MANIFOLDS

Collettori Industriali / Industrial Manifolds
IVR INOX BASIC

IVR 893

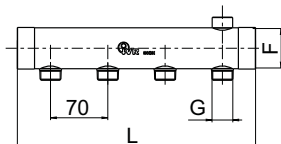

Collettore Industriale in acciaio inox AISI 304 1"1/2 - 2". interasse 70 mm., attacchi da 3/4", attacco per rubinetto carico/scarico, trattamento di elettrolucidatura

Stainless steel AISI 304 Industrial Manifold 1"1/2 - 2", outlet distance 70 mm, connections 3/4", draining valve connection, electropolished treatment

Industrie-Verteiler aus rostfreiem Edelstahl AISI 304 1"1/2 - 2" - Abstand 70 mm. Mit 3/4" Anschlüsse - Ein- und Ablassventil (1" Zwischenstück / Adapter), Elektropoliturbehandlung

Collecteur Industriel en acier inox AISI 304 1"1/2 - 2", entraxe 70mm, fixations de 3/4", traitement d'électropolissage

Индустриальный коллектор из нержавеющей стали AISI 304 1"1/2 - 2", выходы 3/4", межосевое расстояние 70мм, соединение для дренажного крана, электрополировка

Cod./Code	(F) Misura/Size	(G) Attacco/Connection	Vie/Ways	L(mm)	H(mm)	□/田	€
189342704	1"1/2	3/4" M	4	291	1	65,14	
189342705	1"1/2	3/4" M	5	361	1	71,87	
189342706	1"1/2	3/4" M	6	431	1	80,77	
189342707	1"1/2	3/4" M	7	501	1	90,23	
189342708	1"1/2	3/4" M	8	571	1	99,69	
189342709	1"1/2	3/4" M	9	641	1	111,22	
189342710	1"1/2	3/4" M	10	711	1	124,43	
189342711	1"1/2	3/4" M	11	781	1	135,76	
189342712	1"1/2	3/4" M	12	851	1	147,12	
189342713	1"1/2	3/4" M	13	921	1	158,45	
188342714	1"1/2	3/4" M	14	991	1	169,79	
189352704	2"	3/4" M	4	299	1	74,06	
189352705	2"	3/4" M	5	369	1	84,53	
189352706	2"	3/4" M	6	439	1	98,12	
189352707	2"	3/4" M	7	509	1	103,53	
189352708	2"	3/4" M	8	579	1	113,93	
189352709	2"	3/4" M	9	649	1	128,46	
189352710	2"	3/4" M	10	719	1	145,98	
189352711	2"	3/4" M	11	789	1	153,97	
189352712	2"	3/4" M	12	859	1	166,45	
189352713	2"	3/4" M	13	929	1	163,91	
189352714	2"	3/4" M	14	999	1	187,25	



IVR 462

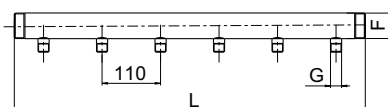

Collettore in acciaio inox AISI 304 da 1"1/2 - 2", con attacchi M/M da 1/2", interasse 110 mm; adatto per contatore acqua

Stainless steel AISI 304 Manifold 1"1/2 - 2" - connections M/M 1/2", center hole distance 110 mm; for water meter

Verteiler aus rostfreiem Stahl AISI 304 - 1"1/2 - 2" - alle Anschlüsse mit (AG x AG) Außengewinde 1/2", Abstand 110 mm; geeignet für Wasserzähler

Collecteur en acier inox AISI 304 de 1"1/2 - 2" - avec fixations M/M de 1/2", entraxe 110 mm pour compteur pour eau

Коллектор из нержавеющей стали AISI 304 1"1/2 - 2", выходы 1/2" Н/Н, межосевое расстояние 110 мм, для счетчиков воды

Cod./Code	(F) Misura/Size	(G) Attacco/Connection	Vie/Ways	L(mm)	□/田	€
146240502	1"1/2	1/2" M	2	220	5	45,00
146240503	1"1/2	1/2" M	3	330	5	57,09
146240504	1"1/2	1/2" M	4	440	5	67,30
146240505	1"1/2	1/2" M	5	550	10	75,72
146240506	1"1/2	1/2" M	6	660	10	84,05
146240507	1"1/2	1/2" M	7	770	5	86,76
146240508	1"1/2	1/2" M	8	880	6	102,59
146240509	1"1/2	1/2" M	9	990	6	113,00
146240510	1"1/2	1/2" M	10	1100	6	119,08
146250502	2"	1/2" M	2	224	10	50,63
146250503	2"	1/2" M	3	334	10	58,96
146250504	2"	1/2" M	4	444	5	66,55
146250505	2"	1/2" M	5	554	5	74,22
146250506	2"	1/2" M	6	664	5	81,80
146250507	2"	1/2" M	7	774	5	91,26
146250508	2"	1/2" M	8	884	5	98,84
146250509	2"	1/2" M	9	994	5	108,50
146250510	2"	1/2" M	10	1104	5	130,33

IVR 463

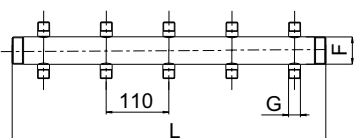

Collettore in acciaio inox AISI 304 da 1"1/2 - 2", con attacchi M/M da 1/2", interasse 110 mm; adatto per contatore acqua con attacchi contrapposti

Stainless steel AISI 304 manifold 1"1/2 - 2" - connections M/M 1/2", center hole distance 110 mm; for water meter with parallel connections

Verteiler aus rostfreiem Stahl AISI 304 - 1"1/2 - 2" - alle Anschlüsse AG/AG 1/2", Abstand 110 mm; geeignet für Wasserzähler mit Parallelanschlüssen

Collecteur en acier inox AISI 304 de 1"1/2 - 2" - avec fixations M/M de 1/2", entraxe 110 mm pour compteur pour eau avec fixations parallèles

Коллектор из нержавеющей стали AISI 304, диаметр 1"1/2 - 2", выходы 1/2" Н/Н, межосевое расстояние 110 мм, для счетчиков воды с противоположными соединениями

Cod./Code	(F) Misura/Size	(G) Attacco/Connection	Vie/Ways	L(mm)	□/田	€
146340503	1"1/2	1/2" M	3+3	330	1	90,84
146340504	1"1/2	1/2" M	4+4	440	1	112,30
146340505	1"1/2	1/2" M	5+5	550	1	131,97
146350503	2"	1/2" M	3+3	334	1	101,63
146350504	2"	1/2" M	4+4	444	1	121,13
146350505	2"	1/2" M	5+5	554	1	140,63



COLLETTORI / MANIFOLDS

Collettori Industriali / Industrial Manifolds

IVR INOX ACCESSORIES

Accessori per collettori IVR-INOX
Accessories for manifolds IVR-INOX
Zubehöre für Verteiler IVR-INOX
Accessoires pour collecteurs IVR-INOX
Аксессуары для коллекторов IVR-INOX

IVR 86/A - IVR 86/B

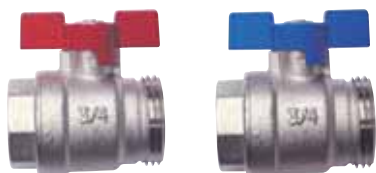

Maniglia farfalla rossa - Maniglia farfalla blu, sede conica
Red butterfly handle - Blue butterfly handle, conical seat
Rot und/oder Blau Flügelgriff mit Kugelsitz
Poignée papillon rouge - poignée papillon bleu avec siège conique
Красная ручка-бабочка - Синяя ручка-бабочка, коническое седло

Cod./Code	Misura/Size	Attacco/Connection	□/田	€
108607102	Red 3/4"	1"	10/60	7,46
108607104	Blue 3/4"	1"	10/60	7,46

IVR 551/C



Detentore dritto, attacco tubo ferro, senza bocchettone, nichelato. Per IVR-INOX
Straight heavy lockshield, iron pipe connection, without tail piece, nickel plated. For IVR-INOX
Gerade Rücklaufverschraubung für Eisenrohr, ohne Stutzen, vernickelt. Für IVR-INOX
Coude droit, fixation tube fer, raccord autoétanche, nickelé. Pour IVR-INOX
Прямой отсекающий клапан, соединение для стальной трубы, без муфты, никелированный. Для IVR-INOX

Cod./Code	Misura/Size	Attacco/Connection	□/田	€
155107010	3/4"	1"	10/120	7,00

IVR 566/C



Valvola termostattizzabile dritta con cappello, attacco tubo ferro, senza bocchettone, nichelato. Per IVR-INOX
Straight thermostatic valve with plastic cap, iron pipe connection, without tail piece, nickel plated. For IVR-INOX
Thermostatventil mit gerader Verschraubung und Einstellkappe, ohne Stutzen, vernickelt. Für Verteiler IVR-INOX
Vanne thermostatisable avec chapeau de réglage, fixation tube fer, sans raccord, nickelée. Pour IVR-INOX
Прямой никелированный термостатический клапан с пластиковым колпачком, соединение для стальной трубы, без муфты. Для IVR-INOX

Cod./Code	Misura/Size	Attacco/Connection	□/田	€
156607010	3/4"	1"	10/60	8,59

IVR 406



Nipples in acciaio inox AISI 304. Per collettori IVR-INOX
AISI 304 stainless steel nipples. For manifolds IVR-INOX
Nippel aus rostfreiem Edelstahl AISI 304. Für Verteiler IVR-INOX
Raccords autoétanche en acier AISI 304. Pour collecteurs IVR-INOX
Ниппели из нержавеющей стали AISI 304. Для коллекторов IVR-INOX

Cod./Code	Misura/Size	□/⊞	€
140615001	1"1/2	10/120	17,61
140620001	2"	10/60	16,33

IVR 416



Tappo M in acciaio inox AISI 304. Per IVR-INOX
Stainless steel AISI 304 M plug. For IVR-INOX
Deckel AG aus rostfreiem Stahl AISI 304. Für IVR-INOX
Bouchon M en acier inox AISI 304. Pour IVR-INOX
Заглушка из нержавеющей стали AISI 304 с наружной резьбой. Для коллекторов IVR-INOX

Cod./Code	Misura/Size	□/⊞	€
141615001	1"1/2	10/120	16,25
141620001	2"	10/60	17,90

IVR 417



Tappo F in acciaio inox AISI 304. Per IVR-INOX 462
Stainless steel AISI 304 F plug. For IVR-INOX 462
Deckel IG aus rostfreiem Stahl AISI 304. Für IVR-INOX 462
Bouchon F en acier inox AISI 304. Pour IVR-INOX 462
Заглушка из нержавеющей стали AISI 304 с внутренней резьбой. Для IVR-INOX 462

Cod./Code	Misura/Size	□/⊞	€
141715001	1" 1/2	10/120	14,46
141720001	2"	10/120	15,61

IVR 844

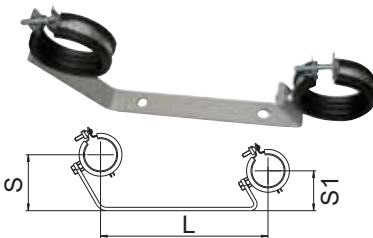

Zanca doppia per collettori. Per IVR-INOX
Dual bracket for modular manifolds. For IVR-INOX
Doppelklammern für Verteiler IVR-INOX
Plaque d'ancrage double pour collecteurs. Pour IVR-INOX
Двойной кронштейн для коллекторов IVR-INOX

Cod./Code	Misura/Size	S (mm)	L (mm)	S1 (mm)	□/⊞	€
184415001	1"1/2	83	250	59	2	17,39
184420001	2"	87	250	63	2	21,28

IVR 847 I

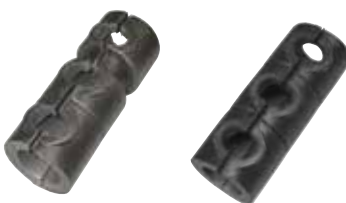

Uscita zanca
At the outlet
Bei der Ausgang
Près de la sortie
Выход-кронштейн

Uscita intermedia
In the middle
In der Mitte
Dans la moitié
Промежуточный выход

Guscio isolante. Per IVR-INOX
Isolating element. For IVR-INOX
Isolierhülse. Für Verteiler IVR-INOX
Coque isolante. Pour collecteurs IVR-INOX
Изолирующий элемент. Для IVR-INOX

Cod./Code	Misura/Size	□/⊞	€
184715031	1"1/2 - iniziale zanca - 3 uscite	10	19,20
184715032	1"1/2 - intermedio - 3 uscite	10	19,20
184720031	2" - iniziale zanca - 3 uscite	10	20,29
184720032	2" - intermedio - 3 uscite	10	20,29



COLLETTORI / MANIFOLDS

Collettori in ottone / Brass Manifolds

SUNNY FLOOR MODULAR

Collettore componibile stampato in ottone interasse 38 mm M/F 3/4" - 1"; nichelato
Modular manifold forged brass, centre hole distance 38 mm M/F 3/4" - 1"; nickel-plated
Modularer Verteiler aus Pressmessing, Stützen-Abstand 38 mm, AG/IG 3/4" - 1"; vernickelt
Collecteur pré-assemblé en laiton Entraxe 38 mm M/F 3/4" - 1"; nickelé
Модульный никелированный коллектор из штампованной латуни. Соединение Н/В 3/4" - 1", межосевое расстояние 38 мм.

IVR 872

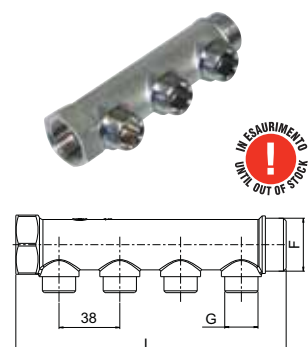

Collettori con attacchi M 1/2"
M 1/2" connections
Anschlüsse AG 1/2"
Fixation M 1/2"
Коллекторы с соединениями Н 1/2"

Cod./Code	(F) Misura/Size	(G) Attacco/Connection	Vie/Ways	L(mm)	□/田	€
187211302	3/4"	1/2"	2	90	10/60	6,99
187211303	3/4"	1/2"	3	128	10/60	10,01
187211304	3/4"	1/2"	4	166	10/60	12,97
187221302	1"	1/2"	2	96	10/60	8,15
187221303	1"	1/2"	3	131	10/60	11,32
187221304	1"	1/2"	4	169	10/40	15,22

IVR 873

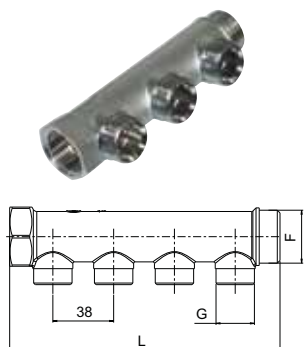

Collettori con attacchi M 24-19
M 24-19 connections
Anschlüsse AG M 24-19
Fixation M 24-19
Коллекторы с соединениями Н 24-19

Cod./Code	(F) Misura/Size	(G) Attacco/Connection	Vie/Ways	L(mm)	□/田	€
187311302	3/4"	24-19	2	90	10/60	7,27
187311303	3/4"	24-19	3	128	10/60	10,04
187311304	3/4"	24-19	4	166	10/60	13,00
187321302	1"	24-19	2	96	10/60	8,22
187321303	1"	24-19	3	131	10/60	11,32
187321304	1"	24-19	4	169	10/40	15,22

IVR 874

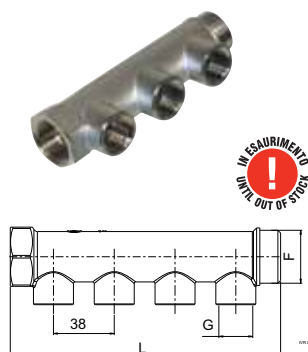

Collettori con attacchi F 1/2"
F 1/2" connections
Anschlüsse IG 1/2"
Fixation F 1/2"
Коллекторы с соединениями В 1/2"

Cod./Code	(F) Misura/Size	(G) Attacco/Connection	Vie/Ways	L(mm)	□/田	€
187411302	3/4"	1/2"	2	90	10/60	6,90
187411303	3/4"	1/2"	3	128	10/60	9,81
187411304	3/4"	1/2"	4	166	10/60	12,88
187421302	1"	1/2"	2	96	10/60	8,15
187421303	1"	1/2"	3	131	10/60	11,32
187421304	1"	1/2"	4	169	10/40	15,22

IVR 858

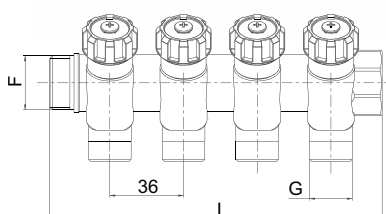

Collettori componibili stampati in ottone con rubinetti d'intercettazione - interasse 36 mm - M/F 3/4" - derivazioni M 1/2" - nichelato

Modular manifolds forged brass with stop cocks - outlet distance 36 mm - M/F 3/4" - with M 1/2" connection - nickel-plated

Modulare Verteiler aus Pressmessing mit Absperrventilen - Stützen-Abstand 36 mm - AG/IG 3/4" - Ableitung AG 1/2" - vernickelt

Collecteurs modulables estampés en laiton avec robinets de sectionnement - entraxe 36 mm - M/F 3/4" - Fixation M 1/2" - nickelé

Модульные никелированные коллекторы из штампованной латуни с запорными клапанами - межосевое расстояние 36мм - Н/В 3/4" - отводы Н 1/2"-никелированные

Cod./Code	(F) Misura/Size	(G) Attacco/Connection	Vie/Ways	L(mm)	□/田	€
18581202	3/4"	1/2"	2	92	10/60	15,86
18581203	3/4"	1/2"	3	128	10/40	22,88
18581204	3/4"	1/2"	4	164	10/40	29,74

Collettori componibili stampati in ottone con rubinetti d'intercettazione - interasse 36 mm - M/F 1" - derivazioni M 1/2" - nichelato

Modular manifolds forged brass with stop cocks - outlet distance 36 mm - M/F 1" - with M 1/2" connection - nickel-plated

Modulare Verteiler, aus Pressmessing mit Absperrventilen - Abstand 36 mm - AG/IG 1" - Ableitung AG 1/2" - vernickelt

Collecteurs modulables estampés en laiton avec robinets de sectionnement - entraxe 36 mm - M/F 1" - fixation M 1/2" - nickelé

Модульные никелированные коллекторы из штампованной латуни с запорными клапанами - межосевое расстояние 36мм - Н/В 1" - отводы Н 1/2"-никелированные

Cod./Code	(F) Misura/Size	(G) Attacco/Connection	Vie/Ways	L(mm)	□/田	€
185821202	1"	1/2"	2	103	10/60	21,94
185821203	1"	1/2"	3	139	10/40	31,31
185821204	1"	1/2"	4	175	10/40	41,18

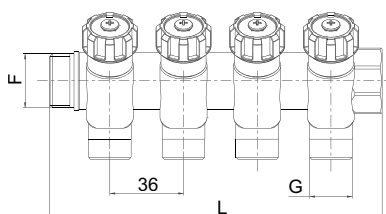

Collettori componibili stampati in ottone con rubinetti d'intercettazione - interasse 36 mm - M/F 3/4" - derivazioni M 24-19 - nichelato

Modular manifolds forged brass with stop cocks - outlet distance 36 mm - M/F 3/4" - with M 24-19 connection - nickel-plated

Modulare Verteiler, aus Pressmessing mit Absperrventilen - Stützen-Abstand 36 mm - AG/IG 3/4" - Ableitung AG 24-19 - vernickelt

Collecteurs modulables estampés en laiton avec robinets de sectionnement - entraxe 36 mm - M/F 3/4" - Fixations M 24-19 - nickelé

Модульные никелированные коллекторы из штампованной латуни с запорными клапанами - межосевое расстояние 36мм - Н/В 3/4"- отводы Н 24-19-никелированные

Cod./Code	(F) Misura/Size	(G) Attacco/Connection	Vie/Ways	L(mm)	□/田	€
185813202	3/4"	24-19	2	92	10/60	16,20
185813203	3/4"	24-19	3	128	10/40	23,18
185813204	3/4"	24-19	4	164	10/40	30,49

Collettori componibili stampati in ottone con rubinetti d'intercettazione - interasse 36 mm - M/F 1" - derivazioni M 24-19 - nichelato

Modular manifolds forged brass with stop cocks - outlet distance 36 mm - M/F 1" - with M 24-19 connection - nickel-plated

Modulare Verteiler aus Pressmessing mit Absperrventilen - Stützen-Abstand 36 mm - IG/AG 1" - Ableitung AG 24-19 - vernickelt

Collecteurs modulables estampés en laiton avec robinets de sectionnement - entraxe 36 mm - M/F 1" - Fixations M 24-19 - nickelé

Модульные никелированные коллекторы из штампованной латуни с запорными клапанами - межосевое расстояние 36мм - Н/В 1" - отводы Н 24-19 - никелированные

Cod./Code	(F) Misura/Size	(G) Attacco/Connection	Vie/Ways	L(mm)	□/田	€
185823202	1"	24-19	2	103	10/60	22,58
185823203	1"	24-19	3	139	10/40	31,88
185823204	1"	24-19	4	175	10/40	41,89



COLLETTORI / MANIFOLDS ACCESSORI / ACCESSORIES

IVR 580



Adattatori preassemblati per tubo rame - Nichelato
Adapters preassembled for copper pipe - Nickel plated
Vormontierter Adapter / Zwischenstücke für Kupferrohr - Vernickelt
Adaptateurs préassemblés pour tubes en cuivre - Niklé
Собранный адаптер для медной трубы - никелированный

Cod./Code	Misura/Size	Attacco/Connection	□/田	€
158005100	10	1/2"	20/400	3,00
158005120	12	1/2"	20/400	1,88
158005140	14	1/2"	20/400	2,21
158005150	15	1/2"	20/400	1,95
158005160	16	1/2"	20/400	2,21
158024100	10	24-19	20/400	2,74
158024120	12	24-19	20/400	2,10
158024140	14	24-19	20/300	2,60
158024150	15	24-19	20/300	2,14
158024160	16	24-19	20/400	2,14
158024180	18	24-19	20/400	2,21
158007120	12	3/4" EK	20/300	2,66
158007140	14	3/4" EK	20/300	2,63
158007150	15	3/4" EK	20/300	3,23
158007160	16	3/4" EK	20/300	2,25
158007180	18	3/4" EK	20/300	2,36

IVR 581



Adattatori universali a compressione per tubi multistrato e polietilene reticolato PEX, nichelati - Nickelated
Adapters for multilayer pipe and cross-linked polyethylene pipe PEX, nickel plated - Nickel plated
Universal-Adapttern-Zwischenstücke für Mehrschichtrohren und aus vernetztem und vernickeltem Polyethylen PEX - vernickelt
Adaptateurs universels à compression pour tubes multicouche et polyéthylène réticulé PEX - nichelés - nichelés
Никелированные универсальные компрессионные адаптеры для металлопластиковых труб ,труб из сшитого полиэтилена PEX, никелированных труб

Cod./Code	Misura/Size	Attacco/Connection	□/田	€
158105143	14 x 2	1/2"	20/400	2,06
158105156	15 x 2,5	1/2"	20/400	2,06
158105163	16 x 2	1/2"	20/300	2,21
158105164	16 x 2,25	1/2"	20/400	2,59
158124143	14 x 2	24-19	20/400	3,56
158124156	15 x 2,5	24-19	20/400	2,35
158124163	16 x 2	24-19	20/400	2,35
158124164	16 x 2,25	24-19	20/400	2,35
158124173	17 x 2	24-19	20/400	3,00
158124183	18 x 2	24-19	20/400	2,85
158124203	20 x 2	24-19	20/300	3,68
158107143	14 x 2	3/4" EK	20/240	2,35
158107163	16 x 2	3/4" EK	20/300	2,26
158107173	17 x 2	3/4" EK	20/300	4,01
158107183	18 x 2	3/4" EK	20/300	4,65
158107203	20 x 2	3/4" EK	20/300	3,60
158110203	20 x 2	1"	10/150	3,28
158110255	25 x 2,3	1"	10/150	4,14
158110256	25 x 2,5	1"	10/150	4,05
158110268	26 x 3	1"	10/80	4,05

IVR 830 CASSETTE METALLICHE



Armadio universale in acciaio zincato in lamiera preverniciata RAL 9010 per alloggiamento collettore. Include: base incasso, 2 kit guide regolabili, 2 piedini regolabili (regolazione consentita: da 0 a 100 mm), frontalino con rete elettrosaldata anche sul dorso per facilitare l'aggrappaggio dell'intonaco; porta e cornice in lamiera preverniciata RAL 9010 regolabile in profondità (regolazione consentita: da 0 a 50 mm)

Universal galvanised steel cabinet in pre-varnished sheet metal RAL 9010 designed to house the manifold. It includes: base for jointing, nr. 2 adjustable feet (allowed adjustment from 0 to 100mm), plastering and removal soaking front, net electrically welded to make plastering easier; door and frame in pre-varnished sheet metal RAL 9010 with adjustable depth (from 0 to 50 mm).

Universalschrank aus verzinktem rostfreiem Stahl aus lackierte Metallschicht RAL 9010 für Verteiler. Ausgestattet mit: Fuss für Montage, 2 Kits von verstellbaren Führungsschienen, 2 verstellbaren Füßchen (von 0 bis zum 100mm), elektrogeschweißtem Netz vorne und hinten zu einem guten Verputzen; Tur und Rahmen aus lackierter Metallschicht RAL 9010 mit verstellbarer Tiefe (von 0 bis zum 50 mm).

Armoire universel en acier galvanisé en tôle avec une couche de vernis RAL 9010 pour mettre le collecteur. Il inclut: la base pour le montage, 2 kits de coulisseaux réglables, 2 pieds réglables (de 0 à 100 mm), une grillage électrosoudée arrière et derrière faciliter l'accrochage de l'enduit; porte et corniche en tôle avec une couche de vernis RAL 9010 avec la profondeur réglable (de 0 à 50 mm).

Универсальный шкаф из оцинкованной стали с полимерным покрытием RAL 9010 предназначен для монтажа коллекторов. Состоит из: основа для монтажа, 2 набора монтажных регулируемых реек, 2 регулируемые ножки (позволенная регулировка по высоте от 0 до 100мм), стенки шкафа и сетка для монтажа электросварин, а также задняя панель для облегчения адгезии строительной штукатурки, выдвигаемая рамка с дверцей окрашены RAL 9010 позволяет регулировать глубину установки (позволенная регулировка: от 0 до 50 мм)

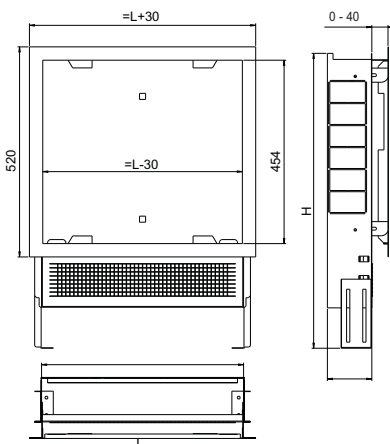

Cod./Code	L(mm)	H(mm)	P(mm)	MAX	□/田	€
1830040009	400	min. 630 max 730	90	3+3	1	87,83
1830050009	500	min. 630 max 730	90	5+5	1	93,83
1830060009	600	min. 630 max 730	90	7+7	1	106,58
1830070009	700	min. 630 max 730	90	9+9	1	114,41
1830085009	850	min. 630 max 730	90	12+12	1	136,80
1830100009	1000	min. 630 max 730	90	13+13	1	154,39
1830120009	1200	min. 630 max 730	90		1	173,70
1830130009	1300	min. 630 max 730	90		1	185,74
183004001	400	min. 630 max 730	110	3+3	1	88,91
1830050011	500	min. 630 max 730	110	5+5	1	94,84
183006001	600	min. 630 max 730	110	7+7	1	107,78
183007001	700	min. 630 max 730	110	9+9	1	115,54
1830085011	850	min. 630 max 730	110	12+12	1	137,93
183010001	1000	min. 630 max 730	110	13+13	1	155,63
183012001	1200	min. 630 max 730	110		1	174,79
1830130011	1300	min. 630 max 730	110		1	186,83
1830040015	400	min. 630 max 730	150	3+3	1	95,70
1830050015	500	min. 630 max 730	150	5+5	1	103,09
1830060015	600	min. 630 max 730	150	7+7	1	114,26
1830070015	700	min. 630 max 730	150	9+9	1	122,81
1830085015	850	min. 630 max 730	150	12+12	1	144,75
1830100015	1000	min. 630 max 730	150	13+13	1	163,09
1830120015	1200	min. 630 max 730	150		1	182,74
1830130015	1300	min. 630 max 730	150		1	195,83

IVR 831 CASSETTE PLASTICHE



Cassetta in plastica universale per collettori, con set supporto collettori; per IVR 872-873-874

Plastic cabinet, with manifolds mounting set; for IVR 872-873-874

Universalgeläuse aus Plastik für Verteiler, mit Verteilerhalterungsset; für IVR 872-873-874

Cassette en plastique universelle pour collecteurs, avec set support collecteurs; pour IVR 872-873-874

Универсальный пластиковый шкаф с монтажным набором - для коллекторов IVR 872-873-874

Cod./Code	Misura/Size	MAX	□/田	€
183103201	320 x 265 x 80	4	1/10	23,55
183104001	400 x 265 x 80	7	1/10	26,63
183105001	500 x 265 x 80	9	1/10	30,60
183106001	600 x 265 x 80	11	1/10	36,38

IVR 360 AIRVENT AUTO



Valvola automatica di sfogo aria Ø 42 sfogo aria superiore, nichelata
 Automatic air-vent nickel-plated - Ø 42 top air-vent
 Automatisches Entlüftungsventil vernickelt - Ø 42 - Entlüftung oben -
 Vanne automatique purgeur d'air nickelée - Ø 42 vanne automatique de purge supérieure
 Автоматический воздухоотводчик ,никелированный - Ø 42 - воздухоотвод вертикальный

Cod./Code	Misura/Size	□/田	€
136003001	3/8"	16/64	6,81
136005001	1/2"	16/64	6,81
136007001	3/4"	16/64	6,81

IVR 361



Valvola automatica di sfogo aria Ø 39 attacco laterale, nichelata
 Automatic air-vent nickel-plated - Ø 39 side connection
 Automatisches Entlüftungsventil vernickelt - Ø 39 - mit seitlichem Außenanschlussgewinde
 Vanne automatique purgeur d'air nickelée - Ø 39 fixation lateral
 Автоматический воздухоотводчик, никелированный - Ø 39 с боковым подключением

Cod./Code	Misura/Size	□/田	€
136103001	3/8"	10/60	7,73
136105001	1/2"	10/60	7,73

IVR 816



Valvola automatica di sfogo aria, sfogo aria laterale, nichelata
 Automatic air-vent, side air-vent, nickel-plated
 Automatisches Entlüftungsventil vernickelt - Entlüftung seitlich
 Vanne automatique purgeur d'air nickelée - purgeur d'air lateral
 Автоматический воздухоотводчик никелированный - воздухоотвод боковой

Cod./Code	Misura/Size	□/田	€
181603001	3/8"	16/64	6,81

IVR 832



Valvola automatica di sfogo aria Ø 50 sfogo aria superiore, nichelata
 Automatic air-vent, Ø 50 top air-vent, nickel-plated
 Automatisches Entlüftungsventil vernickelt - Ø 50 - Entlüftung oben -
 Vanne automatique purgeur d'air nickelée - Purge d'air Ø 50 superieur
 Автоматический воздухоотводчик никелированный - Ø 50 - воздухоотвод вертикальный

Cod./Code	Misura/Size	□/田	€
183203001	3/8"	10/60	7,29
183205001	1/2"	10/60	7,29

IVR 364



Tappo per radiatori con valvola automatica di sfogo aria, nichelato
Automatic air-vent for radiators, nickel-plated - Automatic / nickel-plated
Entlüftungsventil für Heizkörper vernickelt - Automatisches Entlüftung
Vanne purgeur d'air pour radiateur - automatique / nickelée
Заглушка для радиаторов с никелированным автоматическим воздухоотводчиком

Cod./Code	Misura/Size	□/田	€
136410001	1" DX	10/50	6,81
136410002	1" SX	10/50	6,81
136412001	1"1/4 DX	10/60	8,27
136412002	1"1/4 SX	10/60	8,27

IVR 367



Valvola sfogo aria per radiatori manuale, nichelata
Automatic air-vent for radiators, Nickel-plated - Manual / Nickel-plated
Entlüftungsventil für Heizkörper vernickelt, - Manuelles Entlüftung
Vanne purgeur d'air pour radiateur - manuel / nickelée
Воздухоотводчик для радиаторов , ручной , никелированный

Cod./Code	Misura/Size	□/田	€
136702001	1/4"	100/1000	0,83
136703001	3/8"	100/800	1,05
136705001	1/2"	75/450	1,44

IVR 833



Valvola sfogo aria per radiatori manuale con tenuta P.T.F.E. nichelata
Automatic air-vent for radiators, nickel-plated - Manual with P.T.F.E. seal
Entlüftungsventil für Heizkörper vernickelt - Manuelles Entlüftung - mit P.T.F.E. - Dichtung
Vanne purgeur d'air pour radiateur, nickelée - Vanne manuelle avec tenue en P.T.F.E.
Воздухоотводчик для радиаторов, ручной, никелированный с уплотнением P.T.F.E.

Cod./Code	Misura/Size	□/田	€
183303001	3/8"	100/600	1,19
183305001	1/2"	50/600	1,63

IVR 837



Rubinetto d'intercettazione per valvola automatica di sfogo aria
Interception valve for automatic air vent
Absperrentil für automatisches Entlüftungsventil
Robinet de sectionnement pour la vanne de purge de l'air
Отсекающий кран для автоматического воздухоотводчика

Cod./Code	Misura/Size	□/田	€
183703031	3/8" x 3/8"	50/900	1,17
183703051	3/8" x 1/2"	50/750	1,95
183705051	1/2" x 1/2"	50/750	1,54

IVR 838



Valvola sfogo aria per radiatore manuale / orientabile, nichelata
 Automatic air-vent for radiators, nickel-plated - Manual / Orientable
 Entlüftungsventil für Heizkörper vernickelt, - Manuelles Entlüftung - einstellbar
 Vanne purgeur d'air pour radiateur, nickelée - Vanne manuelle de purge d'air orientable
 Воздухоотводчик для радиаторов, никелированный - ручной / регулируемый

Cod./Code	Misura/Size	□/田	€
183803001	3/8"	100/1200	1,13
183805001	1/2"	100/1200	1,13

IVR 836 DRAIN



Rubinetto orientabile di carico-scarico
 Water fill & drain valve
 Ausrichtbares Ein-/Ablassventil von Wasser
 Robinet orientable de chargement/déchargement de l'eau
 Регулируемый дренажный клапан

Cod./Code	Misura/Size	□/田	€
183605001	1/2"	10/120	5,28

IVR 836/I DRAIN

NEW



Rubinetto orientabile di carico-scarico
 Drain valve
 Ausrichtbares Wasserfüllung und-Entleerungshahn
 Robinet orientable de chargement/évacuation eau
 Регулируемый уклонный дренажный клапан

Cod./Code	Misura/Size	□/田	€
183605100	1/2"	10/120	4,14

IVR 836/P DRAIN

NEW



Rubinetto orientabile inclinato di carico-scarico in tecnopolimero
 Rotating angle fill & drain valve in technopolymer
 Drehbares Ein-/Anlassventil aus Technopolymere
 Robinet orientable de chargement/déchargement en technopolymère
 Регулируемый уклонный дренажный клапан из технополимера



Cod./Code	Misura/Size	□/田	€
183605150	1/2"	10/120	2,66

IVR 411 RACCORDI TERMINALI



Raccordo terminale M con autotenuta, nichelato
Manifold plug. Nickel-plated - M with auto-seal
Endanschluss. Vernickelt - AG mit Selbstdichtung
Raccord terminal. Nickelé - M avec auto-étanche
Концевое никелированное соединение для коллектора с наружной резьбой и самогерметизацией

Cod./Code	Misura/Size	□/田	€
141107531	3/4" M x 1/2" x 3/8"	10/180	4,45
141110531	1" M x 1/2" x 3/8"	10/180	5,70
141112531	1"1/4 M x 1/2" x 3/8"	10/160	6,00

IVR 408



Raccordo terminale M con autotenuta e dado, nichelato
Manifold plug. Nickel-plated - M with Auto-seal and nut
Endanschluss - vernickelt - AG - mit Selbstdichtung und Überwurfmutter
Raccord Terminal, nickelé - M avec joint et écrou
Концевое никелированное соединение для коллектора с наружной резьбой, гайкой и самогерметизацией

Cod./Code	Misura/Size	□/田	€
140810551	1" x 1/2" x 1/2" TERM MAS C/GHI	15/180	5,37

IVR 405 NIPLO



Niples con autotenuta, nichelato
Nickel-plated auto-seal nipples
Vernickeltes Nippel mit Selbstdichtung
Raccords avec auto-étanche nickelés
Ниппель с самогерметизацией, никелированный

Cod./Code	Misura/Size	□/田	€
140507001	3/4"	10/240	4,39
140510001	1"	25/150	4,35
140512001	1"1/4	10/180	6,49

IVR 407 NIPLO



Nipples orientabile con autotenuta, nichelato
 Nickel-plated rotatable nipple with auto-seal
 Drehbares vernickeltes Nippel mit Selbstdichtung
 Raccords orientables avec auto-étanche nickelés
 Регулируемый ниппель с самогерметизацией, никелированный

Cod./Code	Misura/Size	□/田	€
140710001	1"	10/180	7,76
140712001	1"1/4	10/120	12,53

IVR 311



Raccordo in tre pezzi con autotenuta e sede conica, dritto, nichelato
 Three-piece fitting with auto seal. Nickel-plated - straight. Conical seat
 Dreiteiliger Anschluss mit Selbstdichtung. Vernickelt - gerade. Kegelsitz
 Raccord en trois pièces avec auto-étanche. Nickelé - droit. Siège conique
 Трехсоставной фитинг с самогерметизацией, никелированный - прямой с коническим седлом

Cod./Code	Misura/Size	□/田	€
131107001	3/4"	10/120	16,16
131110001	1"	10/40	22,58

IVR 316



Raccordo in tre pezzi con autotenuta e sede conica, a gomito, nichelato
 Three pieces fitting with auto seal. Nickel-plated - elbow
 Dreiteiliger winkel Anschluss - selbstdichtend - vernickelt
 Raccord trois pièces autoétanche, nickelé - Courbé
 Трехсоставной фитинг с самогерметизацией, никелированный с коническим седлом, согнут под прямым углом

Cod./Code	Misura/Size	□/田	€
131607001	3/4"	10/80	14,59
131610001	1"	10/40	16,91

IVR 896



Set collegamento (4 pezzi) per AVANT FLOOR
 Connection set (4 pcs) for AVANT FLOOR
 Anschlussgarnitur (4 Stk.) für AVANT FLOOR
 Kit connexion (4 pièces) pour AVANT FLOOR
 Комплект содинений (4 шт) для коллекторов AVANT FLOOR

Cod./Code	Misura/Size	□/田	€
189610101	1" x 1"	10/40	15,67

IVR 412



Tappo F - nichelato
 F plug - Nickel-plated
 Deckel IG - vernickelt
 Bouchon F nickelé
 Никелированная заглушка с внутренней резьбой

Cod./Code	Misura/Size	□/田	€
141204001	24 - 19	50/900	2,34
141205001	1/2"	50/1200	1,78
141207001	3/4"	50/900	2,11
141210001	1"	25/450	2,78
141212001	1" x 1/4"	20/200	3,28

IVR 414



Tappo M per collettore nichelato
M plug for manifolds IVR 893. Nickel-plated
Deckel AG für IVR 893. Vernickelt
Bouchon M pour IVR 893. Nickelé
Никелированная заглушка с наружной резьбой для коллекторов

Cod./Code	Misura/Size	□/田	€
141405001	1/2"	50/1200	1,04
141407001	3/4"	50/900	1,66
141410001	1"	50/600	1,69
141412001	1"1/4	50/300	4,36
141420001	2"	10/60	16,48

IVR 415



Riduzione M/F nichelata
M/F open plug. Nickel-plated
Deckel AG/IG. Vernickelt
Bouchon M/F. Nickelé
Переходник Н/В, никелированный

Cod./Code	Misura/Size	□/田	€
141507031	3/4" M x 3/8" F	50/900	1,61
141507051	3/4" M x 1/2" F	50/900	1,69
141510031	1" M x 3/8" F	50/300	2,89
141510051	1" M x 1/2" F	50/300	2,74
141510071	1" M x 3/4" F	50/300	2,63
141512051	1"1/4 M x 1/2" F	50/300	5,33
141512101	1"1/4 M x 1" F	50/300	4,20

IVR 829

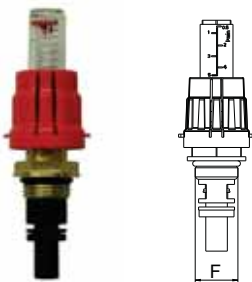

Misuratore di portata in ottone
Flow meter in brass
Durchflussmesser aus Messing
Mesureur de débit en laiton
Расходомер из латуни

Cod./Code	Misura/Size	F	□/田	€
182910105	0,5 + 5 l/min - per/for AVANT FLOOR	1/2"	15/60	7,41
182910108	0,5 + 8 l/min - per/for AVANT FLOOR	1/2"	15/60	7,45

IVR 829/P

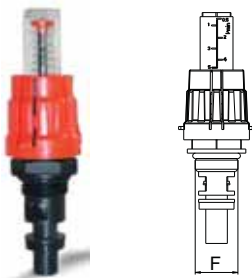

Misuratore di portata in tecnopolimero
Flow meter in technopolymer
Durchflussmesser aus Technopolymer
Mesureur de débit en technopolymère
Расходомер из технополимера

Cod./Code	Misura/Size	F	□/田	€
182910155	0,5 + 5 l/min - per/for AVANT FLOOR	1/2"	15/60	6,70

IVR MULTIKLIMA 483



Dimensioni - Sizes - Maßen - Fixation - Размеры:
H = 550 mm • L = 550 mm • P = 110-150 mm

Modulo IVR MULTIKLIMA 483 con valvola 3 vie con by pass, bilanciamento statico e miscelatore ACS/AFS
IVR MULTIKLIMA 483 Metering unit - with 3-way valve with by-pass, static balancing valve and HSW/CSW mixing valve

IVR MULTIKLIMA 483 Zählermodul mit 3-Wege Kugelhahn mit Bypass, statischem Ausgleich und Warm oder-Kaltwassermischung

IVR MULTIKLIMA 483 Module pour la comptabilisation avec vanne à 3 voies avec by-pass, vanne d'équilibrage statique et mitigeur ECS/EFS

IVR MULTIKLIMA 483 - Узел учета с трёхходовым клапаном с бай-пассом, статическим балансировочным и смесительным клапаном ГВС/ХВС



IVR MULTIKLIMA 483 PLUS

Modulo IVR MULTIKLIMA 483 PLUS con linea per acqua di servizio

IVR MULTIKLIMA 483 PLUS Metering Set with additional grey water line

IVR MULTIKLIMA 483 PLUS Zählermodul mit zusätzlicher Nutzwasserleitung

IVR MULTIKLIMA 483 PLUS Module pour la comptabilisation avec la ligne additionnelle de l'eau de récupération

IVR MULTIKLIMA 483 Plus с линией дополнительной подачи для технической воды

D



Lettura diretta
Direct visual display
Direktauslesung
Lecture directe
Система прямого считывания

M



Lettura M-Bus
M-Bus data transmission
M-Bus-Auslesung
Lecture M-Bus
Система дисперизации M-Bus (M-Бас)

R



Lettura Radio
Radio data transmission
Funkauslesung
Lecture Radio
Система Радио

H/C



Risc. / Raffresc.
Heating / cooling
Heizen / Kühlen
Chauffage / refroidissement
Отопление / охлаждение

MIX



Con miscelatore ACS/AFS
With mixing valve HSW/CSW
Modul mit Warm-/Kaltwassermischung
Mitigeur ECS/EFS
Со смесительным клапаном ГВС/ХВС

COMPLETE DI MISURATORI - WITH FLOW METERS

IVR 483 LINEE RISCALDAMENTO - HEATING RANGE					
D/M/R	Q3	H/C	COD. SX. LEFT	COD. DX RIGHT	€
D	1,5 mc/h	H/C	M83D014G02	M83D114G02	595,37
D	2,5 mc/h	H/C	M83D024G02	M83D124G02	606,22
M	1,5 mc/h	H/C	M83M014G02	M83M114G02	668,02
M	2,5 mc/h	H/C	M83M024G02	M83M124G02	678,87
R	1,5 mc/h	H/C	M83R014G02	M83R114G02	736,84
R	2,5 mc/h	H/C	M83R024G02	M83R124G02	747,69

IVR 400 LINEE SANITARIE - SANITARY HOT AND COLD WATER LINES					
D/M/R	QP	AFS/ACS	CODICE		€
D	2,5 mc/h	ACS/HSW	ML1D020G02		68,01
D	2,5 mc/h	AFS/CSW	ML0D020G02		55,39
D	2,5 mc/h	DUALE/GREY	ML4D020G02		55,39
D	2,5 mc/h	MIX	ML2D02MG02		261,50
M	2,5 mc/h	ACS/HSW	ML1M020G02		99,94
M	2,5 mc/h	AFS/CSW	ML0M020G02		91,33
M	2,5 mc/h	DUALE/GREY	ML4M020G02		91,33
M	2,5 mc/h	MIX	ML2M02MG02		329,37
R	2,5 mc/h	ACS/HSW	ML1R020G02		99,94
R	2,5 mc/h	AFS/CSW	ML0R020G02		91,33
R	2,5 mc/h	DUALE/GREY	ML4R020G02		91,33
R	2,5 mc/h	MIX	ML2R02MG02		329,51

SENZA MISURATORI CON TRONCHETTO SPAZIATORE - WITHOUT FLOW METERS WITH CONNECTION PIPES

LINEE RISCALDAMENTO - HEATING RANGE			
Q3	H/C	COD. SX/DX	€
3/4" F x 110 mm	H/C	M83B010A02	256,61
1" F x 130 mm	H/C	M83B020A02	259,05

LINEE SANITARIE - SANITARY HOT AND COLD WATER LINES			
QP	AFS/ACS	COD. SX/DX	€
3/4" F x 110 mm	ACS/HSW	ML1B020G02	27,87
3/4" F x 110 mm	AFS/CSW	ML0B020G02	27,87
3/4" F x 110 mm	MIX	ML2B02MG02	197,26
3/4" F x 110 mm	DUALE/GREY	ML4B020G02	29,58

CASSETTE, ZANCHE, ARMADI MULTIUTENZA - CABINETS, BRACKETS, MULTI-USERS CABINETS

IVR 409 CASSETTA / ZANCHE - CABINETS/BRACKETS			
D/M/R	DIMENSIONI	COD. SX/DX	€
D/M	550 X 550	MB55027D01	220,34
R	550 X 550	MB55027R01	233,20
D/M	650 X 550	MB65027D01	302,91
R	650 X 550	MB65027R01	315,00
ZANCA	350 X 550	MB01527Z01	80,01
ZANCA	550 X 550	MB05527Z01	153,11
ZANCA	650 X 550	MB06527Z01	164,58

CASSETTA MULTIUTENZA - MULTI-USER CABINETS			
D/M/R	DIMENSIONI	COD. SX/DX	€
D/M	2 UTENZE 1080 X 550	MB72027D01	543,33
R	2 UTENZE 1080 X 550	MB72027R01	586,74
D/M	3 UTENZE 1630 X 550	MB73027D01	835,71
R	3 UTENZE 1630 X 550	MB73027R01	900,82
D/M	4 UTENZE 2180 X 550	MB74027D01	1079,63
R	4 UTENZE 2180 X 550	MB74027R01	1166,44

IVR MULTIKLIMA 473



Dimensioni - Sizes - Maßen - Fixation - Размеры:
H = 550 mm • L = 550 mm • P = 110-150 mm

Modulo IVR MULTIKLIMA 473 - con valvola 3 vie con by pass e miscelatore ACS/AFS
IVR MULTIKLIMA 473 Metering Set - with 3 ways valve with by pass and mixing valve DHW/DCW
IVR MULTIKLIMA 473 Modul mit 3 Wege Kugelhahn mit Bypass und Warm-/Kaltwassermischung
IVR MULTIKLIMA 473 Module pour la comptabilisation avec vanne à 3 voies avec by-pass et mitigeur ECS/EFS
IVR MULTIKLIMA 473 Узел учета - с трехходовым клапаном, бай-пасом и смесительным клапаном ГВС/ХВС



IVR MULTIKLIMA 473 PLUS

Modulo IVR MULTIKLIMA 473 PLUS con linea per acqua di servizio
IVR MULTIKLIMA 473 PLUS Metering Set with additional grey water line
IVR MULTIKLIMA 473 PLUS Zählermodul mit zusätzlicher Nutzwasserleitung
IVR MULTIKLIMA 473 PLUS Module pour la comptabilisation avec la ligne additionnelle de l'eau de récupération
IVR MULTIKLIMA 473 Plus с линией дополнительной подачи для технической воды

D Lettura diretta
Direct visual display
Direktauslesung
Lecture directe
Система прямого считывания

M Lettura M-Bus
M-Bus data transmission
M-Bus-Auslesung
Lecture M-Bus
Система диспетчеризации M-Bus (M-Bac)

R Lettura Radio
Radio data transmission
Funkauslesung
Lecture Radio
Система Радио

H/C Risc. / Raffresc.
Heating / cooling
Heizen / Kühlen
Chauffage / refroidissement
Отопление / охлаждение

MIX Con miscelatore ACS/AFS
With mixing valve HSW/CSW
Modul mit Warm-/Kaltwassermischung
Mitigeur ECS/EFS
Со смесительным клапаном ГВС/ХВС

COMPLETE DI MISURATORI - WITH FLOW METERS

IVR 473 LINEE RISCALDAMENTO - HEATING RANGE					
D/M/R	Q3	H/C	COD. SX. LEFT	COD. DX. RIGHT	€
D	1,5 mc/h	H/C	M73D014G02	M73D114G02	520,74
D	2,5 mc/h	H/C	M73D024G02	M73D124G02	531,59
M	1,5 mc/h	H/C	M73M014G02	M73M114G02	593,39
M	2,5 mc/h	H/C	M73M024G02	M73M124G02	604,24
R	1,5 mc/h	H/C	M73R014G02	M73R114G02	662,21
R	2,5 mc/h	H/C	M73R024G02	M73R124G02	673,06

IVR 400 LINEE SANITARIE - SANITARY HOT AND COLD WATER LINES				
D/M/R	QP	AFS/ACS	CODICE	€
D	2,5 mc/h	ACS/HSW	ML1D020G02	68,01
D	2,5 mc/h	AFS/CSW	ML0D020G02	55,39
D	2,5 mc/h	DUALE/GREY	ML4D020G02	55,39
D	2,5 mc/h	MIX	ML2D02MG02	261,50
M	2,5 mc/h	ACS/HSW	ML1M020G02	99,94
M	2,5 mc/h	AFS/CSW	ML0M020G02	91,33
M	2,5 mc/h	DUALE/GREY	ML4M020G02	91,33
M	2,5 mc/h	MIX	ML2M02MG02	329,37
R	2,5 mc/h	ACS/HSW	ML1R020G02	99,94
R	2,5 mc/h	AFS/CSW	ML0R020G02	91,33
R	2,5 mc/h	DUALE/GREY	ML4R020G02	91,33
R	2,5 mc/h	MIX	ML2R02MG02	329,51

SENZA MISURATORI CON TRONCHETTO SPAZIATORE - WITHOUT FLOW METERS WITH CONNECTION PIPES

LINEE RISCALDAMENTO - HEATING RANGE			
Q3	H/C	COD. SX/DX	€
3/4" F x 110 mm	H/C	M73B010A02	181,98
1" F x 130 mm	H/C	M73B020A02	184,42

LINEE SANITARIE - SANITARY HOT AND COLD WATER LINES			
QP	AFS/ACS	COD. SX/DX	€
3/4" F x 110 mm	ACS/HSW	ML1B020G02	27,87
3/4" F x 110 mm	AFS/CSW	ML0B020G02	27,87
3/4" F x 110 mm	MIX	ML2B02MG02	197,26
3/4" F x 110 mm	DUALE/GREY	ML4B020G02	29,58

CASSETTE, ZANCHE, ARMADI MULTIUTENZA - CABINETS, BRACKETS, MULTI-USERS CABINETS

IVR 409 CASSETTA / ZANCHE - CABINETS/BRACKETS			
D/M/R	DIMENSIONI	COD. SX/DX	€
D/M	550 X 550	MB55027D01	220,34
R	550 X 550	MB55027R01	233,20
D/M	650 X 550	MB65027D01	302,91
R	650 X 550	MB65027R01	315,00
ZANCA	350 X 550	MB01527Z01	80,01
ZANCA	550 X 550	MB05527Z01	153,11
ZANCA	650 X 550	MB06527Z01	164,58

CASSETTA MULTIUTENZA - MULTI-USER CABINETS			
D/M/R	DIMENSIONI	COD. SX/DX	€
D/M	2 UTENZE 1080 X 550	MB72027D01	543,33
R	2 UTENZE 1080 X 550	MB72027R01	586,74
D/M	3 UTENZE 1630 X 550	MB73027D01	835,71
R	3 UTENZE 1630 X 550	MB73027R01	900,82
D/M	4 UTENZE 2180 X 550	MB74027D01	1079,63
R	4 UTENZE 2180 X 550	MB74027R01	1166,44

IVR MULTIKLIMA 482



Dimensioni - Sizes - Maßen - Fixation - Размеры:
H = 550 mm • L = 550 mm • P = 110-150 mm



IVR MULTIKLIMA 482 PLUS

Modulo IVR MULTIKLIMA 482 PLUS con linea per acqua di servizio
IVR MULTIKLIMA 482 PLUS Metering Set with additional grey water line
IVR MULTIKLIMA 482 PLUS Zählermodul mit zusätzlicher Nutzwasserleitung
IVR MULTIKLIMA 482 PLUS Module pour la comptabilisation avec la ligne additionnelle de l'eau de récupération
IVR MULTIKLIMA 482 Plus с линией дополнительной подачи для технической воды

D Lettura diretta
Direct visual display
Direktauslesung
Lecture directe
Система прямого считывания

M Lettura M-Bus
M-Bus data transmission
M-Bus-Auslesung
Lecture M-Bus
Система дисперизации M-Bus (M-Бас)

R Lettura Radio
Radio data transmission
Funkauslesung
Lecture Radio
Система Радио

H/C Risc. / Raffresc.
Heating / cooling
Heizen / Kühlen
Chauffage / refroidissement
Отопление / охлаждение

MIX Con miscelatore ACS/AFS
With mixing valve HSW/CSW
Modul mit Warm-/Kaltwasser Mischung
Mitigeur ECS/EFS
Со смесительным клапаном ГВС/ХВС

COMPLETE DI MISURATORI - WITH FLOW METERS

IVR 482 LINEE RISCALDAMENTO - HEATING RANGE					
D/M/R	Q3	H/C	COD. SX. LEFT	COD. DX RIGHT	€
D	1,5 mc/h	H/C	M82D014G02	M82D114G02	578,48
D	2,5 mc/h	H/C	M82D024G02	M82D124G02	591,08
M	1,5 mc/h	H/C	M82M014G02	M82M114G02	651,13
M	2,5 mc/h	H/C	M82M024G02	M82M124G02	663,72
R	1,5 mc/h	H/C	M82R014G02	M82R114G02	719,95
R	2,5 mc/h	H/C	M82R024G02	M82R124G02	732,55

IVR 400 LINEE SANITARIE - SANITARY HOT AND COLD WATER LINES					
D/M/R	QP	AFS/ACS	CODICE		€
D	2,5 mc/h	ACS/HSW	ML1D020G02		68,01
D	2,5 mc/h	AFS/CSW	ML0D020G02		55,39
D	2,5 mc/h	DUALE/GREY	ML4D020G02		55,39
D	2,5 mc/h	MIX	ML2D02MG02		261,50
M	2,5 mc/h	ACS/HSW	ML1M020G02		99,94
M	2,5 mc/h	AFS/CSW	ML0M020G02		91,33
M	2,5 mc/h	DUALE/GREY	ML4M020G02		91,33
M	2,5 mc/h	MIX	ML2M02MG02		329,37
R	2,5 mc/h	ACS/HSW	ML1R020G02		99,94
R	2,5 mc/h	AFS/CSW	ML0R020G02		91,33
R	2,5 mc/h	DUALE/GREY	ML4R020G02		91,33
R	2,5 mc/h	MIX	ML2R02MG02		329,51

SENZA MISURATORI CON TRONCHETTO SPAZIATORE - WITHOUT FLOW METERS WITH CONNECTION PIPES

LINEE RISCALDAMENTO - HEATING RANGE			
Q3	H/C	COD. SX/DX	€
3/4" F x 110 mm	H/C	M82B010A02	239,71
1" F x 130 mm	H/C	M82B020A02	243,90

LINEE SANITARIE - SANITARY HOT AND COLD WATER LINES			
QP	AFS/ACS	COD. SX/DX	€
3/4" F x 110 mm	ACS/HSW	ML1B020G02	27,87
3/4" F x 110 mm	AFS/CSW	ML0B020G02	27,87
3/4" F x 110 mm	MIX	ML2B02MG02	197,26
3/4" F x 110 mm	DUALE/GREY	ML4B020G02	29,58

CASSETTE, ZANCHE, ARMADI MULTIUTENZA - CABINETS, BRACKETS, MULTI-USERS CABINETS

IVR 409 CASSETTA / ZANCHE - CABINETS/BRACKETS			
D/M/R	DIMENSIONI	COD. SX/DX	€
D/M	550 X 550	MB55027D01	220,34
R	550 X 550	MB55027R01	233,20
D/M	650 X 550	MB65027D01	302,91
R	650 X 550	MB65027R01	315,00
ZANCA	350 X 550	MB01527Z01	80,01
ZANCA	550 X 550	MB05527Z01	153,11
ZANCA	650 X 550	MB06527Z01	164,58

CASSETTA MULTIUTENZA - MULTI-USER CABINETS			
D/M/R	DIMENSIONI	COD. SX/DX	€
D/M	2 UTENZE 1080 X 550	MB72027D01	543,33
R	2 UTENZE 1080 X 550	MB72027R01	586,74
D/M	3 UTENZE 1630 X 550	MB73027D01	835,71
R	3 UTENZE 1630 X 550	MB73027R01	900,82
D/M	4 UTENZE 2180 X 550	MB74027D01	1079,63
R	4 UTENZE 2180 X 550	MB74027R01	1166,44

IVR MULTIKLIMA 472



Dimensioni - Sizes - Maßen - Fixation - Размеры:
H = 550 mm • L = 550 mm • P = 110-150 mm

Modulo IVR MULTIKLIMA 472 - con valvola 2 vie e miscelatore ACS/AFS
IVR MULTIKLIMA 472 Metering Set - with 2 ways valve and mixing valve DHW/DCW
IVR MULTIKLIMA 472 Modul mit 2 Wege Kugelhahn und Warm-/Kaltwassermischung
Module IVR MULTIKLIMA 472 avec vanne 2 voies et mitigeur ECS/EFS
IVR MULTIKLIMA 472 Узел учета - с двухходовым клапаном и смесительным клапаном ГВС/ХВС



IVR MULTIKLIMA 472 PLUS

Modulo IVR MULTIKLIMA 472 PLUS con linea per acqua di servizio
IVR MULTIKLIMA 472 PLUS Metering Set with additional grey water line
IVR MULTIKLIMA 472 PLUS Zählermodul mit zusätzlicher Nutzwasserleitung
IVR MULTIKLIMA 472 PLUS Module pour la comptabilisation avec la ligne additionnelle de l'eau de récupération
IVR MULTIKLIMA 472 Plus с линией дополнительной подачи для технической воды



D Lettura diretta Direct visual display Direktauslesung Lecture directe Система прямого считывания	M Lettura M-Bus M-Bus data transmission M-Bus-Auslesung Lecture M-Bus Система диспетчеризации M-Bus (M-Bac)	R Lettura Radio Radio data transmission Funkauslesung Lecture Radio Система Радио	H/C Risc. / Raffresc. Heating / cooling Heizen / Kühlen Chauffage / refroidissement Отопление / охлаждение	MIX Con miscelatore ACS/AFS With mixing valve HSW/CSW Modul mit Warm-/Kaltwassermischung Mitigeur ECS/EFS Со смесительным клапаном ГВС/ХВС
--	---	---	--	--

COMPLETE DI MISURATORI - WITH FLOW METERS

IVR 472 LINEE RISCALDAMENTO - HEATING RANGE					
D/M/R	Q3	H/C	COD. SX. LEFT	COD. DX RIGHT	€
D	1,5 mc/h	H/C	M72D014G02	M72D114G02	503,85
D	2,5 mc/h	H/C	M72D024G02	M72D124G02	516,45
M	1,5 mc/h	H/C	M72M014G02	M72M114G02	576,50
M	2,5 mc/h	H/C	M72M024G02	M72M124G02	589,10
R	1,5 mc/h	H/C	M72R014G02	M72R114G02	645,32
R	2,5 mc/h	H/C	M72R024G02	M72R124G02	657,92

IVR 400 LINEE SANITARIE - SANITARY HOT AND COLD WATER LINES					
D/M/R	QP	AFS/ACS	CODICE	€	
D	2,5 mc/h	ACS/HSW	ML1D020G02	68,01	
D	2,5 mc/h	AFS/CSW	ML0D020G02	55,39	
D	2,5 mc/h	DUALE/GREY	ML4D020G02	55,39	
D	2,5 mc/h	MIX	ML2D02MG02	261,50	
M	2,5 mc/h	ACS/HSW	ML1M020G02	99,94	
M	2,5 mc/h	AFS/CSW	ML0M020G02	91,33	
M	2,5 mc/h	DUALE/GREY	ML4M020G02	91,33	
M	2,5 mc/h	MIX	ML2M02MG02	329,37	
R	2,5 mc/h	ACS/HSW	ML1R020G02	99,94	
R	2,5 mc/h	AFS/CSW	ML0R020G02	91,33	
R	2,5 mc/h	DUALE/GREY	ML4R020G02	91,33	
R	2,5 mc/h	MIX	ML2R02MG02	329,51	

SENZA MISURATORI CON TRONCHETTO SPAZIATORE - WITHOUT FLOW METERS WITH CONNECTION PIPES

LINEE RISCALDAMENTO - HEATING RANGE			
Q3	H/C	COD. SX/DX	€
3/4" F x 110 mm	H/C	M72B010A02	165,09
1" F x 130 mm	H/C	M72B020A02	169,27

LINEE SANITARIE - SANITARY HOT AND COLD WATER LINES			
QP	AFS/ACS	COD. SX/DX	€
3/4" F x 110 mm	ACS/HSW	ML1B020G02	27,87
3/4" F x 110 mm	AFS/CSW	ML0B020G02	27,87
3/4" F x 110 mm	MIX	ML2B02MG02	197,26
3/4" F x 110 mm	DUALE/GREY	ML4B020G02	29,58

CASSETTE, ZANCHE, ARMADI MULTIUTENZA - CABINETS, BRACKETS, MULTI-USERS CABINETS

IVR 409 CASSETTA / ZANCHE - CABINETS/BRACKETS			
D/M/R	DIMENSIONI	COD. SX/DX	€
D/M	550 X 550	MB55027D01	220,34
R	550 X 550	MB55027R01	233,20
D/M	650 X 550	MB65027D01	302,91
R	650 X 550	MB65027R01	315,00
ZANCA	350 X 550	MB01527Z01	80,01
ZANCA	550 X 550	MB05527Z01	153,11
ZANCA	650 X 550	MB06527Z01	164,58

CASSETTA MULTIUTENZA - MULTI-USER CABINETS			
D/M/R	DIMENSIONI	COD. SX/DX	€
D/M	2 UTENZE 1080 X 550	MB72027D01	543,33
R	2 UTENZE 1080 X 550	MB72027R01	586,74
D/M	3 UTENZE 1630 X 550	MB73027D01	835,71
R	3 UTENZE 1630 X 550	MB73027R01	900,82
D/M	4 UTENZE 2180 X 550	MB74027D01	1079,63
R	4 UTENZE 2180 X 550	MB74027R01	1166,44

IVR MULTIKLIMA 481



Dimensioni - Sizes - Maßen - Fixation - Размеры:
H = 550 mm • L = 550 mm • P = 110-150 mm



Modulo IVR MULTIKLIMA 481 - con bilanciamento statico e miscelatore ACS/AFS
IVR MULTIKLIMA 481 Metering Set - with static balancing valve and mixing valve DHW/DCW
IVR MULTIKLIMA 481 Modul mit statischem Ausgleich und Warm-/Kaltwasseremischung
Module IVR MULTIKLIMA 481 avec vanne d'équilibrage statique et mitigeur ECS/EFS
IVR MULTIKLIMA 481- Узел учета со статическим балансирующим клапаном и смесительным клапаном ГВС/ХВС

IVR MULTIKLIMA 481 PLUS

Modulo IVR MULTIKLIMA 481 PLUS con linea per acqua di servizio
IVR MULTIKLIMA 481 PLUS Metering Set with additional grey water line
IVR MULTIKLIMA 481 PLUS Zählermodul mit zusätzlicher Nutzwasserleitung
IVR MULTIKLIMA 481 PLUS Module pour la comptabilisation avec la ligne additionnelle de l'eau de récupération
IVR MULTIKLIMA 481 Plus с линией дополнительной подачи для технической воды

D Lettura diretta
Direct visual display
Direktauslesung
Lecture directe
Система прямого считывания

M Lettura M-Bus
M-Bus data transmission
M-Bus-Auslesung
Lecture M-Bus
Система диспертизации M-Bus (M-Бас)

R Lettura Radio
Radio data transmission
Funkauslesung
Lecture Radio
Система Радио

H/C Risc. / Raffresc.
Heating / cooling
Heizen / Kühlen
Chauffage / refroidissement
Отопление / охлаждение

MIX Con miscelatore ACS/AFS
With mixing valve HSW/CSW
Modul mit Warm-/Kaltwasseremischung
Mitigeur ECS/EFS
Со смесительным клапаном ГВС/ХВС

COMPLETE DI MISURATORI - WITH FLOW METERS

IVR 481 LINEE RISCALDAMENTO - HEATING RANGE					
D/M/R	Q3	H/C	COD. SX. LEFT	COD. DX RIGHT	€
D	1,5 mc/h	H/C	M81D014G02	M81D114G02	483,48
D	2,5 mc/h	H/C	M81D024G02	M81D124G02	496,08
M	1,5 mc/h	H/C	M81M014G02	M81M114G02	556,13
M	2,5 mc/h	H/C	M81M024G02	M81M124G02	568,73
R	1,5 mc/h	H/C	M81R014G02	M81R114G02	624,95
R	2,5 mc/h	H/C	M81R024G02	M81R124G02	637,55

IVR 400 LINEE SANITARIE - SANITARY HOT AND COLD WATER LINES					
D/M/R	QP	AFS/ACS	CODICE		€
D	2,5 mc/h	ACS/HSW	ML1D020G02		68,01
D	2,5 mc/h	AFS/CSW	ML0D020G02		55,39
D	2,5 mc/h	DUALE/GREY	ML4D020G02		55,39
D	2,5 mc/h	MIX	ML2D02MG02		261,50
M	2,5 mc/h	ACS/HSW	ML1M020G02		99,94
M	2,5 mc/h	AFS/CSW	ML0M020G02		91,33
M	2,5 mc/h	DUALE/GREY	ML4M020G02		91,33
M	2,5 mc/h	MIX	ML2M02MG02		329,37
R	2,5 mc/h	ACS/HSW	ML1R020G02		99,94
R	2,5 mc/h	AFS/CSW	ML0R020G02		91,33
R	2,5 mc/h	DUALE/GREY	ML4R020G02		91,33
R	2,5 mc/h	MIX	ML2R02MG02		329,51

SENZA MISURATORI CON TRONCHETTO SPAZIATORE - WITHOUT FLOW METERS WITH CONNECTION PIPES

LINEE RISCALDAMENTO - HEATING RANGE			
Q3	H/C	COD. SX/DX	€
3/4" F x 110 mm	H/C	M81B010A02	144,72
1" F x 130 mm	H/C	M81B020A02	148,90

LINEE SANITARIE - SANITARY HOT AND COLD WATER LINES			
QP	AFS/ACS	COD. SX/DX	€
3/4" F x 110 mm	ACS/HSW	ML1B020G02	27,87
3/4" F x 110 mm	AFS/CSW	ML0B020G02	27,87
3/4" F x 110 mm	MIX	ML2B02MG02	197,26
3/4" F x 110 mm	DUALE/GREY	ML4B020G02	29,58

CASSETTE, ZANCHE, ARMADI MULTIUTENZA - CABINETS, BRACKETS, MULTI-USERS CABINETS

IVR 409 CASSETTA / ZANCHE - CABINETS/BRACKETS			
D/M/R	DIMENSIONI	COD. SX/DX	€
D/M	550 X 550	MB55027D01	220,34
R	550 X 550	MB55027R01	233,20
D/M	650 X 550	MB65027D01	302,91
R	650 X 550	MB65027R01	315,00
ZANCA	350 X 550	MB01527Z01	80,01
ZANCA	550 X 550	MB05527Z01	153,11
ZANCA	650 X 550	MB06527Z01	164,58

CASSETTA MULTIUTENZA - MULTI-USER CABINETS			
D/M/R	DIMENSIONI	COD. SX/DX	€
D/M	2 UTENZE 1080 X 550	MB72027D01	543,33
R	2 UTENZE 1080 X 550	MB72027R01	586,74
D/M	3 UTENZE 1630 X 550	MB73027D01	835,71
R	3 UTENZE 1630 X 550	MB73027R01	900,82
D/M	4 UTENZE 2180 X 550	MB74027D01	1079,63
R	4 UTENZE 2180 X 550	MB74027R01	1166,44

IVR MULTIKLIMA 471



Dimensioni - Sizes - Maßen - Fixation - Размеры:
H = 550 mm • L = 550 mm • P = 110-150 mm

Modulo IVR MULTIKLIMA 471 - con miscelatore ACS/AFS
IVR MULTIKLIMA 471 Metering Set - with mixing valve DHW/DCW
IVR MULTIKLIMA 471 Modul mit Warm-/Kaltwassermischung
Module IVR MULTIKLIMA 471 Mitigeur ECS/EFS
IVR MULTIKLIMA 471 Узел учета со смесительным клапаном ГВС/ХВС



IVR MULTIKLIMA 471 PLUS

Modulo IVR MULTIKLIMA 471 PLUS con linea per acqua di servizio
IVR MULTIKLIMA 471 PLUS Metering Set with additional grey water line
IVR MULTIKLIMA 471 PLUS Zählermodul mit zusätzlicher Nutzwasserleitung
IVR MULTIKLIMA 471 PLUS Module pour la comptabilisation avec la ligne additionnelle de l'eau de récupération
IVR MULTIKLIMA 471 Plus с линией дополнительной подачи для технической воды



D Lettura diretta Direct visual display Direktauslesung Lecture directe Система прямого считывания	M Lettura M-Bus M-Bus data transmission M-Bus-Auslesung Lecture M-Bus Система диспетчеризации M-Bus (M-Bac)	R Lettura Radio Radio data transmission Funkauslesung Lecture Radio Система Радио	H/C Risc. / Raffresc. Heating / cooling Heizen / Kühlen Chauffage / refroidissement Отопление / охлаждение	MIX Con miscelatore ACS/AFS With mixing valve HSW/CSW Modul mit Warm-/Kaltwassermischung Mitigeur ECS/EFS Со смесительным клапаном ГВС/ХВС
--	---	---	--	--

COMPLETE DI MISURATORI - WITH FLOW METERS

IVR 471 LINEE RISCALDAMENTO - HEATING RANGE					
D/M/R	Q3	H/C	COD. SX. LEFT	COD. DX RIGHT	€
D	1,5 mc/h	H/C	M71D014G02	M71D114G02	403,83
D	2,5 mc/h	H/C	M71D024G02	M71D124G02	416,43
M	1,5 mc/h	H/C	M71M014G02	M71M114G02	476,48
M	2,5 mc/h	H/C	M71M024G02	M71M124G02	489,08
R	1,5 mc/h	H/C	M71R014G02	M71R114G02	545,30
R	2,5 mc/h	H/C	M71R024G02	M71R124G02	557,90

IVR 400 LINEE SANITARIE - SANITARY HOT AND COLD WATER LINES				
D/M/R	QP	AFS/ACS	CODICE	€
D	2,5 mc/h	ACS/HSW	ML1D020G02	68,01
D	2,5 mc/h	AFS/CSW	ML0D020G02	55,39
D	2,5 mc/h	DUALE/GREY	ML4D020G02	55,39
D	2,5 mc/h	MIX	ML2D02MG02	261,50
M	2,5 mc/h	ACS/HSW	ML1M020G02	99,94
M	2,5 mc/h	AFS/CSW	ML0M020G02	91,33
M	2,5 mc/h	DUALE/GREY	ML4M020G02	91,33
M	2,5 mc/h	MIX	ML2M02MG02	329,37
R	2,5 mc/h	ACS/HSW	ML1R020G02	99,94
R	2,5 mc/h	AFS/CSW	ML0R020G02	91,33
R	2,5 mc/h	DUALE/GREY	ML4R020G02	91,33
R	2,5 mc/h	MIX	ML2R02MG02	329,51

SENZA MISURATORI CON TRONCHETTO SPAZIATORE - WITHOUT FLOW METERS WITH CONNECTION PIPES

LINEE RISCALDAMENTO - HEATING RANGE			
Q3	H/C	COD. SX/DX	€
3/4" F x 110 mm	H/C	M71B010A02	65,07
1" F x 130 mm	H/C	M71B020A02	69,25

LINEE SANITARIE - SANITARY HOT AND COLD WATER LINES			
QP	AFS/ACS	COD. SX/DX	€
3/4" F x 110 mm	ACS/HSW	ML1B020G02	27,87
3/4" F x 110 mm	AFS/CSW	ML0B020G02	27,87
3/4" F x 110 mm	MIX	ML2B02MG02	197,26
3/4" F x 110 mm	DUALE/GREY	ML4B020G02	29,58

CASSETTE, ZANCHE, ARMADI MULTIUTENZA - CABINETS, BRACKETS, MULTI-USERS CABINETS

IVR 409 CASSETTA / ZANCHE - CABINETS/BRACKETS			
D/M/R	DIMENSIONI	COD. SX/DX	€
D/M	550 X 550	MB55027D01	220,34
R	550 X 550	MB55027R01	233,20
D/M	650 X 550	MB65027D01	302,91
R	650 X 550	MB65027R01	315,00
ZANCA	350 X 550	MB01527Z01	80,01
ZANCA	550 X 550	MB05527Z01	153,11
ZANCA	650 X 550	MB06527Z01	164,58

CASSETTA MULTIUTENZA - MULTI-USER CABINETS			
D/M/R	DIMENSIONI	COD. SX/DX	€
D/M	2 UTENZE 1080 X 550	MB72027D01	543,33
R	2 UTENZE 1080 X 550	MB72027R01	586,74
D/M	3 UTENZE 1630 X 550	MB73027D01	835,71
R	3 UTENZE 1630 X 550	MB73027R01	900,82
D/M	4 UTENZE 2180 X 550	MB74027D01	1079,63
R	4 UTENZE 2180 X 550	MB74027R01	1166,44

ACCESSORI MULTIKLIMA / MULTIKLIMA ACCESSORIES

IVR 4A0



Set 2 tubi di collegamento linee riscaldamento
Set of 2 union pipes for heating lines
Garnitur von 2 Anschlussrohren für die Heizungsleitungen
Set de 2 tubes de connexion pour les lignes de chauffage
Набор из 2-х соединительных труб для сегмента отопления

Cod./Code	□/田	€
4A00000A10	1	26,61

IVR 4A0



Set 2 tubi di collegamento linee acqua sanitaria
Set of 2 union pipes for sanitary water lines
Garnitur von 2 Anschlussrohren für die Wasserleitungen
Set de 2 tubes de connexion pour les lignes de l'eau sanitaire
Набор из 2-х соединительных труб для сегмента санитарного водоснабжения

Cod./Code	□/田	€
4A00000A12	1	25,81

IVR 4A0



Set 3 tubi di collegamento linee acqua sanitaria e acqua duale di servizio
Set of 3 union pipes for sanitary water and greywater lines
Garnitur von 3 Anschlussrohren für Wasser- und Nutwasserleitungen
Set de 3 tubes de connexion pour les lignes de l'eau sanitaire et de l'eau de récupération
Набор из 3-х соединительных труб для сегментов санитарного и технического водоснабжения

Cod./Code	□/田	€
4A00000A13	1	38,56

IVR 4A0



Set 4 di tubi collegamento linee riscaldamento e acqua sanitaria
Set of 4 union pipes for heating and sanitary water lines
Garnitur von 4 Anschlussrohren für Heizungs- und Wasserleitungen
Set de 4 tubes pour les lignes de chauffage et de l'eau sanitaire
Набор из 4-х соединительных труб для сегмента отопления и санитарного водоснабжения

Cod./Code	□/田	€
4A00000A14	1	52,48

IVR 4A0



Set 5 di tubi collegamento linee riscaldamento, acqua sanitaria e acqua duale di servizio
Set of 5 union pipes for heating, sanitary water and greywater lines
Garnitur von 4 Anschlussrohren für Heizungs- und Wasserleitungen
Set de 5 tubes pour les lignes de chauffage, de l'eau sanitaire et de l'eau de récupération
Набор из 5 соединительных труб для сегментов санитарного и технического водоснабжения

Cod./Code	□/田	€
4A00000A15	1	65,10

IVR 847 M



Guscio di coibentazione per linee di riscaldamento/raffrescamento
Insulating shell for heating/cooling lines
Isolierhülse für Heizung/Erkältungsleitungen
Coque isolante pour les lignes de chauffage/rafraîchissement
Изолирующая оболочка для систем нагрева / охлаждения

Cod./Code	□/田	€
335800412 SX	1	43,17
335800413 DX	1	43,17

IVR 496



Centralina Datalogger M-Bus
M-Bus Data logger
M-Bus Datenlogger
Data logger M-Bus
Регистратор данных M-Bus

Cod./Code	□/田	€
149600060 60	1	916,88
149600120 120	1	1556,25
149600250 250	1	1687,50

IVR 335



Convertitore di segnale M-Bus fissaggio a muro
M-Bus signal converter - wall mounting
M-Bus Signalumsetzer - Wandbefestigung
Convertisseur de signal - fixé au mur
Конвертирующий адаптер сигнала M-Bus - настенный монтаж

Cod./Code	□/田	€
335800107	1	137,65

IVR 497



MODEM GSM trasmissione dati con antenna
GSM MODEM for antenna data transmission
GSM MODEM für Übertragungen mittels Antenne
MODEM GSM pour les transmissions avec antenne
МОДЕМ GSM - прибор передачи данных с антенной

Cod./Code	□/田	€
1497PY001	1	621,56

VALVOLE PER RADIATORI / RADIATOR VALVES

Valvole termostatiche / Thermostatic valves
THERMOCHROME



KIT TERMOARREDO composto da valvola termostattizzabile e detentore, cromati
KIT for design radiator with thermostatic valve and lockshield, chrome-plated
DESIGNGARNITUR: Regulierventil (für Thermostat) und Rücklaufverschraubung, verchromt
KIT pour radiateurs design composé de vanne thermostatizable et coude de réglage chromés
Комплект для дизайнерских радиаторов, состоящий из термостатического и отсекающего клапанов, хромированный

IVR 597 CHR



Testa termostatica con sensore a liquido; a bassa inerzia termica - Cromata, dark grey e light grey
Thermostatic head with liquid sensor; low thermal inertia - Chrome-plated, dark grey and light grey
Thermostatkopf mit Flüssigkeitssensor; geringe thermische Trägheit - Verchromt, dark grey und light grey
Tête thermostatique avec capteur à liquide - à faible inertie thermique - Chromée, dark grey et light grey
Термостатическая головка с жидкостным сенсором с низкой термоинерцией - Хромированная.
Цвет: светло-серый и темно-серый

Cod./Code	Misura/Size	□/田	€	
159700701	chrome	M30 x 1,5	1/50	20,00
159700704	dark grey	M30 x 1,5	1/50	20,00
159700705	light grey	M30 x 1,5	1/50	20,00

IVR 777 CHR



A squadra, attacco tubo rame, PEX e multistrato
Angle, PEX, multilayer and copper pipe connection
Eckförmig, Anschluss für Kupfer, PEX und Mehrschichtrohr
Équerre, fixation tube en cuivre, PEX et multicouche
Угловой, соединение для медной, PEX и многослойной трубы

Cod./Code	Misura/Size	Attacco/Connection	□/田	€
177705185	1/2"	24-19	1/15	36,16

IVR 563 CHR

NEW



THERMOCHROME, valvola termostattizzabile a squadra, attacco PEX, multistrato e tubo rame, bocchettone autotenuta, cromata

THERMOCHROME, chrome-plated angle thermostatic valve, PEX, multilayer and copper pipe connection, autoseal tail piece

THERMOCHROME, Eckthermostatventil, Anschluss für PEX, Kupfer- und Mehrschichtrohr, mit Selbstdichtung, verchromt

THERMOCHROME, vanne thermostatizable équerre, fixation PEX, multicouche et tube en cuivre, raccord avec auto-étanche, chromée

THERMOCHROME, термостатический угловой клапан, соединение для PEX, металлопластиковой и стальной трубы. С самогерметизирующимся патрубком хромированный.

Cod./Code	Misura/Size	Attacco/Connection	□/田	€
156305187	1/2"	24-19	1/18	20,04

IVR 557 CHR

NEW



THERMOCHROME, detentore a squadra, attacco PEX, multistrato e tubo rame, bocchettone autotenuta, cromato

THERMOCHROME, chrome-plated angle lockshield, PEX, multilayer and copper pipe connection, autoseal tail piece

THERMOCHROME, Eckrücklaufverschraubung, Anschluss für PEX, für Kupfer- und Mehrschichtrohr, mit Selbstdichtung, verchromt

THERMOCHROME, coude de réglage équerre, fixation PEX, multicouche et tube en cuivre, chromé

THERMOCHROME, угловой стопорный клапан, соединение для PEX, металлопластиковой и стальной трубы. С самогерметизирующимся патрубком. хромированный.

Cod./Code	Misura/Size	Attacco/Connection	□/田	€
155705187	1/2"	24-19	1/18	15,58

IVR 776 CHR



Dritto, attacco tubo rame, PEX e multistrato

Straight, PEX, multilayer and copper pipe connection

gerade, Anschluss für Kupfer, PEX und Mehrschichtrohr

Droit, fixation tube en cuivre, PEX et multicouche

Прямой, соединение для медной, PEX и многослойной трубы

Cod./Code	Misura/Size	Attacco/Connection	□/田	€
177605185	1/2"	24-19	1/15	37,86

IVR 562 CHR

NEW



THERMOCHROME, valvola termostattabile diritta, attacco PEX, multistrato e tubo rame, bocchettone autotenuta, cromata

THERMOCHROME, chrome-plated straight thermostatic valve, PEX, multilayer and copper pipe connection, autoseal tail piece

THERMOCHROME, Gerade Thermostatventil, Anschluss für PEX, Kupfer- und Mehrschichtrohr, mit Selbstdichtung, verchromt

THERMOCHROME, vanne thermostatisable droite, fixation PEX, multicouche et tube en cuivre, raccord avec auto-étanche, chromée

THERMOCHROME, термостатический прямой клапан, соединение для PEX, металлопластиковой и стальной трубы. С самогерметизирующимся патрубком. хромированный.

Cod./Code	Misura/Size	Attacco/Connection	□/田	€
156205187	1/2"	24-19	1/18	20,80

IVR 555 CHR

NEW



THERMOCHROME, detentore diritto, attacco PEX, multistrato e tubo rame, bocchettone autotenuta, cromato

THERMOCHROME, chrome-plated straight lockshield, PEX, multilayer and copper pipe connection, autoseal tail piece

THERMOCHROME, Gerade Rücklaufverschraubung, Anschluss für PEX, für Kupfer- und Mehrschichtrohr, mit Selbstdichtung, verchromt

THERMOCHROME, coude de réglage droit, fixation PEX, multicouche et tube en cuivre, chromé

THERMOCHROME, прямой стопорный клапан, соединение для PEX, металлопластиковой и стальной трубы. С самогерметизирующимся патрубком. хромированный.

Cod./Code	Misura/Size	Attacco/Connection	□/田	€
155505187	1/2"	24-19	1/18	16,52

IVR 774 CHR



A squadra, fornita con adattatore per attacco tubo ferro
Angle, iron pipe connection
Eckförmig, Anschluss für Eisenrohr
Équerre, fixation tube en cuivre
Угловой вентиль, соединение для стальной трубы

Cod./Code	Misura/Size	□/田	€
177405005	1/2"	1/15	51,02

IVR 561 CHR



THERMOCHROME, valvola termostattabile a squadra, fornita con adattatore per attacco tubo ferro, bocchettone autotenuta, cromata
THERMOCHROME, chrome-plated angle thermostatic valve, iron pipe connection, autoseal tail piece
THERMOCHROME, eckförmiges Thermostatventil, Anschluss für Eisenrohr, mit Selbstdichtung, verchromt
THERMOCHROME, vanne thermostatizable équerre, fournie avec adaptateurs pour fixation tube en fer, raccord avec auto-étanche, chromée
THERMOCHROME, термостатический угловой клапан, поставляется с адаптером для стальной трубы, с самогерметизирующимся патрубком. хромированный.

Cod./Code	Misura/Size	□/田	€
156105015	1/2"	1/18	27,21

IVR 553 CHR



THERMOCHROME, detentore a squadra, fornita con adattatore per attacco tubo ferro, bocchettone autotenuta, cromato
THERMOCHROME, chrome-plated angle lockshield, iron pipe connection, autoseal tail piece
THERMOCHROME, Eckrücklaufverschraubung mit Anschluss für Eisenrohr, mit Selbstdichtung, verchromt
THERMOCHROME, coude de réglage équerre, fixation tube en fer, raccord avec auto-étanche, chromée
THERMOCHROME, угловой стопорный клапан, поставляется с адаптером для стальной трубы, с самогерметизирующимся патрубком. хромированный.

Cod./Code	Misura/Size	□/田	€
155305015	1/2"	1/18	22,77

IVR 773 CHR



Dritto, fornita con adattatore per attacco tubo ferro
Straight, iron pipe connection
Gerade Verschraubung, Anschluss für Eisenrohr
Droit, fixation tube fer
Прямой вентиль, соединение для стальной трубы

Cod./Code	Misura/Size	□/田	€
177305005	1/2"	1/15	52,76

IVR 560 CHR



THERMOCHROME, valvola termostattabile diritta, fornita con adattatore per attacco tubo ferro, bocchettone autotenuta, cromata

THERMOCHROME, chrome-plated straight thermostatic valve, iron pipe connection, autoseal tail piece

THERMOCHROME, Gerade Rücklaufverschraubung mit Anschluss für Eisenrohr, mit Selbstdichtung, verchromt

THERMOCHROME, vanne thermostatizable droite, fournie avec adaptateurs pour fixation tube en fer, raccord avec auto-étanche, chromée

THERMOCHROME, термостатический прямой клапан, поставляется с адаптером для стальной трубы, с самогерметизирующимся патрубком. хромированный.

Cod./Code	Misura/Size	□/田	€
156005015	1/2"	1/18	27,96

IVR 551 CHR



THERMOCHROME, detentore diritto, fornita con adattatore per attacco tubo ferro, bocchettone autotenuta, cromato

THERMOCHROME, chrome-plated straight lockshield, iron pipe connection, autoseal tail piece

THERMOCHROME, Gerade Rücklaufverschraubung mit Anschluss für Eisenrohr, mit Selbstdichtung, verchromt

THERMOCHROME, coude de réglage droit, fourni avec adaptateurs pour fixation fixation tube en fer, raccord avec auto-étanche, chromé

THERMOCHROME, прямой стопорный клапан, поставляется с адаптером для стальной трубы, с самогерметизирующимся патрубком. хромированный.

Cod./Code	Misura/Size	□/田	€
155105015	1/2"	1/18	23,69

IVR 580 CHR



Adattatori per tubo rame - Cromati

Adapters for copper pipe - Chrome

Zwischenstücke / Adapter für Kupferrohr - verchromt

Adaptateurs pour tubes en cuivre - Chromé

Фитинги для медной трубы - хромированные

Cod./Code	Misura/Size	Attacco/Connection	CH(mm)	□/田	€
158024710	10	24-19	27	10/180	6,33
158024720	12	24-19	27	10/180	7,04
158024740	14	24-19	27	10/180	5,66
158024750	15	24-19	27	10/180	5,92
158024760	16	24-19	27	10/180	5,19

IVR 581 CHR



Adattatori universali a compressione per tubi multistrato e polietilene reticolato PEX, nichelati - Cromati

Adapters for multilayer pipe and cross-linked polyethylene pipe PEX, nickel plated - chrome-plated

Universal-Zwischenstücke/Adapter zur Kompression für Mehrschichtrohren und Rohren aus vernetztem Polyethylen PEX - vernickelt - verchromt

Adaptateurs universels à compression pour tubes multicouche et polyéthylène réticulé PEX - nickelés - Chromé

Фитинги для многослойной трубы и труб из сшитого полиэтилена PEX, никелированные - хромированные

Cod./Code	Misura/Size	Attacco/Connection	CH(mm)	□/田	€
158124743	14 x 2	24-19	27	10/200	6,88
158124763	16 x 2	24-19	27	10/200	5,96
158124764	16 x 2,2	24-19	27	10/200	5,62

VALVOLE PER RADIATORI / RADIATOR VALVES

Valvole termostatiche / Thermostatic valves



Testa termostatica con sensore a liquido; a bassa inerzia termica
Thermostatic head with liquid sensor; low thermal inertia
Thermostatkopf mit Flüssigkeitssensor; geringe thermische Trägheit
Tête thermostatique avec capteur à liquide - à faible inertie thermique
Термостатическая головка с жидкостным сенсором; с низкой термоинерцией

IVR 597



Testa termostatica con sensore a liquido; a bassa inerzia termica - Bianca, dark grey e light grey
Thermostatic head with liquid sensor; low thermal inertia - White, dark grey and light grey
Thermostatkopf mit Flüssigkeitssensor; geringe thermische Trägheit - Verchromt
Weiß, dark grey und light grey
Tête thermostatique avec capteur à liquide - à faible inertie thermique - Blanc, dark grey et light grey
Термостатическая головка с жидкостным сенсором; с низкой термоинерцией - Белая
Цвет: светло-серый и тёмно-серый

Cod./Code	Misura/Size	□/田	€	
159700001	bianca	M30 x 1,5	1/50	20,00
159700704	dark grey	M30 x 1,5	1/50	20,00
159700705	light grey	M30 x 1,5	1/50	20,00

IVR 599



Testa termostatica con sensore a liquido; a bassa inerzia termica - Con sensore a distanza
Thermostatic head with liquid sensor; low thermal inertia - With remote sensor
Thermostatkopf mit Flüssigkeitssensor; geringe thermische Trägheit. Mit Fernsensor
Tête thermostatique avec capteur à liquide - à faible inertie thermique - Avec capteur à distance
Термостатическая головка с жидкостным сенсором; с низкой термоинерцией - С дистанционным датчиком

Cod./Code	Misura/Size	□/田	€
159900001	M30 x 1,5	1/15	19,36

IVR 591



Testa termostatica con sensore a liquido a bassa inerzia termica - con sonda ad immersione
Thermostatic head with liquid sensor at low thermal inertia - with sensor immersion sleeve
Thermostatkopf mit Flüssigkeitssensor mit geringer thermischen Trägheit - mit Tauchsonde
Tête thermostatique avec capteur à liquide à faible inertie thermique - avec sonde à immersion
Термостатическая головка с жидкостным сенсором, низкой термоинерцией и погружным датчиком

Cod./Code	Misura/Size	□/田	€
159100001	M30 x 1,5	1/20	21,14

VALVOLE PER RADIATORI / RADIATOR VALVES

Valvole termostatiche / Thermostatic valves
SATURN - Attacco tubo ferro / Iron pipe connection



Valvola termostattizzabile attacco tubo ferro, bocchettone con / senza autotenuta, nichelata
Straight thermostatic valve with manual handle, iron pipe connection, with / without auto-seal tail piece; nickel plated
Thermostatventil mit Anschluss für Eisenrohr, mit /ohne Selbstdichtung - vernickelt
Vanne thermostatisable, fixation tube fer, raccord autoétanche ou non étanche - nickelée
Термостатический клапан с ручным управлением, соединение для стальной трубы, с / без самогерметизации; никелированный

IVR 561 - IVR 561/2



IVR 561



IVR 561/2

A squadra con volantino manuale
Angle valve with manual handle
Eckförmig mit Handrad
Equerre avec volant manuel
Угловой клапан с ручным управлением

Cod./Code	Misura/Size	□/田	€
156103000	3/8"	10/60	8,37
156105000	1/2"	10/40	9,37
156107000	3/4"	10/40	12,60
156103002	3/8"	10/60	8,08 (1)
156105002	1/2"	10/40	9,01 (1)
156107002	3/4"	10/40	11,66 (1)

- (1) 561/2 - Art. con bocchettone senza autotenuta
- (1) 561/2 - Item with tail piece without auto-seal
- (1) 561/2 - Art. Ventil mit Stutzen ohne Selbstdichtung
- (1) 561/2 - Art. avec raccord non étanche
- (1) 561/2 - Клапан с патрубком без самогерметизации

IVR 561/3 - IVR 561/4 PREREGOLAZIONE / PRESETTING



IVR 561/3



IVR 561/4

Con prerogolazione, a squadra con volantino manuale
Angle valve with presetting and with manual handle
Eckförmige Verschraubung mit Voreinstellung und Handrad
Avec préréglage, équerre avec volant manuel
Угловой термостатический клапан для радиаторов с преднастройкой и ручным управлением

Cod./Code	Misura/Size	□/田	€
156103003	3/8"	10/60	8,79
156105003	1/2"	10/40	9,80
156107003	3/4"	10/40	13,08
156103004	3/8"	10/60	8,53 (1)
156105004	1/2"	10/40	9,44 (1)
156107004	3/4"	10/40	12,15 (1)

- (1) 561/4 - Art. con bocchettone senza autotenuta
- (1) 561/4 - Item with tail piece without auto-seal
- (1) 561/4 - Art. Ventil mit Stutzen ohne Selbstdichtung
- (1) 561/4 - Art. avec raccord non étanche
- (1) 561/4 - Клапан с патрубком без самогерметизации



IVR 567 - IVR 567/2



IVR 567

IVR 567/2

A squadra con cappello di regolazione
Angle valve with operating plastic cap
Eckförmige Verschraubung mit Einstellkappe
A équerre, avec chapeau de réglage
Угловой термостатический клапан с регулирующим колпачком

Cod./Code	Misura/Size	□/田	€
156703000	3/8"	10/120	7,40
156705000	1/2"	10/120	8,38
156707000	3/4"	10/60	11,63

- (1) 567/2 - Art. con bocchettone senza autotenuta
- (1) 567/2 - Item with tail piece without auto-seal
- (1) 567/2 - Art. Ventil mit Stutzen ohne Selbstdichtung
- (1) 567/2 - Art. avec raccord non étanche
- (1) 567/2 - Клапан с патрубком без самогерметизации

156703002	3/8"	10/120	7,15	(1)
156705002	1/2"	10/120	8,02	(1)
156707002	3/4"	10/60	10,69	(1)

IVR 567/3 - IVR 567/4 PREREGOLAZIONE / PRESETTING



IVR 567/3

IVR 567/4

Con prerregolazione, a squadra con cappello di regolazione
Angle valve with presetting, operating plastic cap
Eckförmige Verschraubung mit Voreinstellung und Einstellkappe
Avec pré-réglage, équerre avec chapeau de réglage
Угловой термостатический клапан с преднастройкой, регулирующий колпачок

Cod./Code	Misura/Size	□/田	€
156703003	3/8"	10/120	7,82
156705003	1/2"	10/120	8,81
156707003	3/4"	10/60	12,11

- (1) 567/4 - Art. con bocchettone senza autotenuta
- (1) 567/4 - Item with tail piece without auto-seal
- (1) 567/4 - Art. Ventil mit Stutzen ohne Selbstdichtung
- (1) 567/4 - Art. avec raccord non étanche
- (1) 567/4 - Клапан с патрубком без самогерметизации

156703004	3/8"	10/120	7,57	(1)
156705004	1/2"	10/120	8,45	(1)
156707004	3/4"	10/60	11,17	(1)

IVR 570 - IVR 570/2



IVR 570

IVR 570/2

Reversa con cappello di regolazione
 Reverse angle valve with operating plastic cap
 Echförmiges Umsteuerungsventil mit Einstellkappe
 À corps inversé avec chapeau de réglage
 Реверсивный угловой термостатический клапан с регулирующим колпачком

- (1) 570/2 - Art. con bocchettone senza autotenuta
- (1) 570/2 - Item with tail piece without auto-seal
- (1) 570/2 - Art. Ventil mit Stutzen ohne Selbstdichtung
- (1) 570/2 - Art. avec raccord non étanche
- (1) 570/2 - Клапан с патрубком без самогерметизации

Cod./Code	Misura/Size	□/田	€
157005000	1/2"	10/60	10,17
157005002	1/2"	10/60	9,81 (1)

IVR 570/3 - IVR 570/4 PREREGOLAZIONE / PRESETTING



IVR 570/3

IVR 570/4

Reversa con prerregolazione, con cappello di regolazione
 Reverse angle valve with presetting and operating plastic cap
 Umsteuerungsventil mit Voreinstellung, mit Einstellkappe
 À corps inversé avec préreglage, avec chapeau de réglage
 Реверсивный термостатический клапан с регулирующим колпачком.

- (1) 570/4 - Art. con bocchettone senza autotenuta
- (1) 570/4 - Item with tail piece without auto-seal
- (1) 570/4 - Art. Ventil mit Stutzen ohne Selbstdichtung
- (1) 570/4 - Art. avec raccord non étanche
- (1) 570/4 - Клапан с патрубком без самогерметизации

Cod./Code	Misura/Size	□/田	€
157005003	1/2"	10/60	10,46
157005004	1/2"	10/60	10,10 (1)

IVR 560 - IVR 560/2



IVR 560

IVR 560/2

Dritta con volantino manuale
 Straight with manual handle
 Gerade mit Handrad
 Droit avec volant manuel
 Прямой термостатический клапан с ручным управлением

- (1) 560/2 - Art. con bocchettone senza autotenuta
- (1) 560/2 - Item with tail piece without auto-seal
- (1) 560/2 - Art. Ventil mit Stutzen ohne Selbstdichtung
- (1) 560/2 - Art. avec raccord non étanche
- (1) 560/2 - Клапан с патрубком без самогерметизации

Cod./Code	Misura/Size	□/田	€
156003000	3/8"	10/60	8,87
156005000	1/2"	10/40	10,26
156007000	3/4"	10/40	13,69
156003002	3/8"	10/60	8,61 (1)
156005002	1/2"	10/40	9,90 (1)
156007002	3/4"	10/40	12,75 (1)

IVR 560/3 - IVR 560/4 PREREGOLAZIONE / PRESETTING



IVR 560/3

IVR 560/4

Con prerogolazione, dritta con volantino manuale
Straight valve with presetting and with manual handle
Gerade Verschraubung mit Voreinstellung und Handrad
Avec pré-réglage, equerre avec volant manuel
Прямой термостатический клапан с преднастройкой и ручным управлением

Cod./Code	Misura/Size	□/田	€	
156003003	3/8"	10/60	9,30	
156005003	1/2"	10/40	10,69	
156007003	3/4"	10/40	14,16	
156003004	3/8"	10/60	9,03	(1)
156005004	1/2"	10/40	10,33	(1)
156007004	3/4"	10/40	13,23	(1)

- (1) 560/4 - Art. con bocchettone senza autotenuta
- (1) 560/4 - Item with tail piece without auto-seal
- (1) 560/4 - Art. Ventil mit Stutzen ohne Selbstdichtung
- (1) 560/4 - Art. avec raccord non étanche
- (1) 560/4 - Клапан с патрубком без самогерметизации

IVR 566 - IVR 566/2



IVR 566

IVR 566/2

Dritta con cappello di regolazione
Straight valve with operating plastic cap
Gerade Verschraubung mit Einstellkappe
Droite avec chapeau de réglage
Прямой термостатический клапан с регулирующим колпачком

Cod./Code	Misura/Size	□/田	€	
156603000	3/8"	10/60	7,92	
156605000	1/2"	10/60	9,27	
156607000	3/4"	10/60	12,70	
156603002	3/8"	10/60	7,66	(1)
156605002	1/2"	10/60	8,91	(1)
156607002	3/4"	10/60	11,77	(1)

- (1) 566/2 - Art. con bocchettone senza autotenuta
- (1) 566/2 - Item with tail piece without auto-seal
- (1) 566/2 - Art. Ventil mit Stutzen ohne Selbstdichtung
- (1) 566/2 - Art. avec raccord non étanche
- (1) 566/2 - Клапан с патрубком без самогерметизации

IVR 566/3 - IVR 566/4 PREREGOLAZIONE / PRESETTING



IVR 566/3

IVR 566/4

Con prerogolazione, dritta con cappello di regolazione
Straight valve with presetting, operating plastic cap
Gerade Verschraubung mit Voreinstellung und Einstellkappe
Avec pré-réglage, droite avec chapeau de réglage
Прямой термостатический клапан с преднастройкой и регулирующим колпачком

Cod./Code	Misura/Size	□/田	€	
156603003	3/8"	10/60	8,35	
156605003	1/2"	10/60	9,70	
156607003	3/4"	10/60	13,18	
156603004	3/8"	10/60	8,08	(1)
156605004	1/2"	10/60	9,34	(1)
156607004	3/4"	10/60	12,24	(1)

- (1) 566/4 - Art. con bocchettone senza autotenuta
- (1) 566/4 - Item with tail piece without auto-seal
- (1) 566/4 - Art. Ventil mit Stutzen ohne Selbstdichtung
- (1) 566/4 - Art. avec raccord non étanche
- (1) 566/4 - Клапан с патрубком без самогерметизации



VALVOLE PER RADIATORI / RADIATOR VALVES

Valvole termostatiche / Thermostatic valves

JUPITER DETENTORE/LOCKSHIELD - Attacco tubo ferro / Iron pipe connection

Detentore per valvole Saturn, attacco tubo ferro, bocchettone con/senza autotenuta, nichelata

Straight heavy lockshield for Saturn valves, iron pipe connection, with/without auto-seal tail piece, nickel plated

Rücklaufverschraubung für Saturn - Ventile, Stutzen mit/ohne Selbstdichtung, vernickelt

Coude de réglage pour vanne Saturn, fixation PEX, multicouche et tube en cuivre, raccord autoétanche ou non étanche, nickelée

Усиленный отсекающий клапан, соединение для стальной трубы, патрубок с / без самогерметизации, никелированный

IVR 553 - IVR 553/2



IVR 553

IVR 553/2

A squadra
Angle lockshield
Eckförmige Rücklaufverschraubung
A équerre
Угловой

Cod./Code	Misura/Size	□/田	€
155303000	3/8"	10/120	5,38
155305000	1/2"	10/120	7,23
155307000	3/4"	10/60	10,01

- (1) 553/2 - Art. con bocchettone senza autotenuta
- (1) 553/2 - Item with tail piece without auto-seal
- (1) 553/2 - Art. Ventil mit Stutzen ohne Selbstdichtung
- (1) 553/2 - Art. avec raccord non étanche
- (1) 553/2 - Клапан с патрубком без самогерметизации

155303002	3/8"	10/120	5,11	(1)
155305002	1/2"	10/120	6,87	(1)
155307002	3/4"	10/60	9,08	(1)

IVR 551 - IVR 551/2



IVR 551

IVR 551/2

Dritto
Straight lockshield
Gerade Rücklaufverschraubung
Droit
Прямой

Cod./Code	Misura/Size	□/田	€
155103000	3/8"	10/120	5,86
155105000	1/2"	10/120	8,39
155107000	3/4"	10/60	11,08

- (1) 551/2 - Art. con bocchettone senza autotenuta
- (1) 551/2 - Item with tail piece without auto-seal
- (1) 551/2 - Art. Ventil mit Stutzen ohne Selbstdichtung
- (1) 551/2 - Art. avec raccord non étanche
- (1) 551/2 - Клапан с патрубком без самогерметизации

155103002	3/8"	10/120	5,59	(1)
155105002	1/2"	10/120	8,03	(1)
155107002	3/4"	10/60	10,14	(1)

VALVOLE PER RADIATORI / RADIATOR VALVES

Valvole termostatiche / Thermostatic valves

SATURN - Attacco PEX/Rame/PEX-AL-PEX / PEX/copper/PEX-AL-PEX

Valvola termostaticabile, attacco PEX, multistrato e tubo rame, bocchettone autotenuta, nichelata
Straight thermostatic valve, PEX, multilayer and copper pipe connection, auto-seal tail piece, nickel plated
Thermostatventil, gerade, mit Anschluss für PEX, Mehrschicht und Kupferrohr, selbstdichtender Stutzen, vernickelt
Vannes thermostatissables fixation pour tubes PEX, multicouche et en cuivre, raccord autoétanche, nickelée
Никелированный термостатический клапан, соединение для труб: медной, PEX и многослойной, самогерметизирующийся патрубок

IVR 563 - IVR 563/2



IVR 563

IVR 563/2

A squadra con volantino manuale
Angle valve with manual handle
Eckförmig mit Handrad
Equerre avec volant manuel
Угловой клапан с ручным управлением

Cod./Code	Misura/Size	Attacco/Connection	□/⊕	€
156303180	3/8"	24-19	10/60	8,20
156305180	1/2"	24-19	10/60	9,10
156303160	3/8"	1/2"	10/60	9,01
156305160	1/2"	1/2"	10/60	9,07
156303182	3/8"	24-19	10/60	7,93
156305182	1/2"	24-19	10/60	8,72
156303162	3/8"	1/2"	10/60	8,75
156305162	1/2"	1/2"	10/60	8,71

- (1) 563/2 - Art. con bocchettone senza autotenuta
(1) 563/2 - Item with tail piece without auto-seal
(1) 563/2 - Art. Ventil mit Stutzen ohne Selbstdichtung
(1) 563/2 - Art. avec raccord non étanche
(1) 563/2 - Клапан с патрубком без самогерметизации

IVR 563/3 - IVR 563/4 PREREGOLAZIONE / PRESETTING



IVR 563/3

IVR 563/4

Con prerogolazione, a squadra con volantino manuale
Angle valve with presetting and with manual handle
Eckförmige Verschraubung mit Voreinstellung und Handrad
Avec préréglage, équerre avec volant manuel
Угловой клапан для радиаторов с преднастройкой и ручным управлением

Cod./Code	Misura/Size	Attacco/Connection	□/⊕	€
156303183	3/8"	24-19	10/60	8,62
156305183	1/2"	24-19	10/60	9,52
156303163	3/8"	1/2"	10/60	10,02
156305163	1/2"	1/2"	10/60	9,52
156303184	3/8"	24-19	10/60	8,36
156305184	1/2"	24-19	10/60	9,16
156303164	3/8"	1/2"	10/60	9,19
156305164	1/2"	1/2"	10/60	9,16

- (1) 563/4 - Art. con bocchettone senza autotenuta
(1) 563/4 - Item with tail piece without auto-seal
(1) 563/4 - Art. Ventil mit Stutzen ohne Selbstdichtung
(1) 563/4 - Art. avec raccord non étanche
(1) 563/4 - Клапан с патрубком без самогерметизации

IVR 569 - IVR 569/2



IVR 569

IVR 569/2

A squadra con cappello di regolazione
 Angle valve with operating plastic cap
 Eckförmige Verschraubung mit Einstellkappe
 A équerre, avec chapeau de réglage
 Угловой клапан с регулирующим колпачком

Cod./Code	Misura/Size	Attacco/Connection	□/⊞	€
156903180	3/8"	24-19	10/120	7,33
156905180	1/2"	24-19	10/120	8,23
156903160	3/8"	1/2"	10/120	8,16
156905160	1/2"	1/2"	10/120	8,22

- (1) 569/2 - Art. con bocchettone senza autotenuta
- (1) 569/2 - Item with tail piece without auto-seal
- (1) 569/2 - Art. Ventil mit Stutzen ohne Selbstdichtung
- (1) 569/2 - Art. avec raccord non étanche
- (1) 569/2 - Клапан с патрубком без самогерметизации

156903182	3/8"	24-19	10/120	7,06	(1)
156905182	1/2"	24-19	10/120	7,87	(1)
156903162	3/8"	1/2"	10/120	7,89	(1)
156905162	1/2"	1/2"	10/120	7,86	(1)

IVR 569/3 - IVR 569/4 PREREGOLAZIONE / PRESETTING



IVR 569/3

IVR 569/4

Con prerregolazione, a squadra con cappello di regolazione
 Angle valve with presetting, operating plastic cap
 Eckförmige Verschraubung mit Voreinstellung und Einstellkappe
 Avec pré-réglage, équerre avec chapeau de réglage
 Угловой клапан с преднастройкой и регулирующим колпачком

Cod./Code	Misura/Size	Attacco/Connection	□/⊞	€
156903183	3/8"	24-19	10/120	7,75
156905183	1/2"	24-19	10/120	8,65
156903163	3/8"	1/2"	10/120	8,58
156905163	1/2"	1/2"	10/120	8,65

- (1) 569/4 - Art. con bocchettone senza autotenuta
- (1) 569/4 - Item with tail piece without auto-seal
- (1) 569/4 - Art. Ventil mit Stutzen ohne Selbstdichtung
- (1) 569/4 - Art. avec raccord non étanche
- (1) 569/4 - Клапан с патрубком без самогерметизации

156903184	3/8"	24-19	10/120	7,49	(1)
156905184	1/2"	24-19	10/120	8,29	(1)
156903164	3/8"	1/2"	10/120	8,32	(1)
156905164	1/2"	1/2"	10/120	8,29	(1)

IVR 571 - IVR 571/2



IVR 571

IVR 571/2

Reversa con cappello di regolazione
 Reverse angle valve with operating plastic cap
 Eckförmiges Umsteuerungsventil mit Einstellkappe
 À corps inversé avec chapeau de réglage
 Реверсивный угловой клапан с регулирующим колпачком

Cod./Code	Misura/Size	Attacco/Connection	□/⊞	€	
157105180	1/2"	24-19	10/60	10,17	
157105182	1/2"	24-19	10/60	9,81	(1)

- (1) 571/2 - Art. con bocchettone senza autotenuta
- (1) 571/2 - Item with tail piece without auto-seal
- (1) 571/2 - Art. Ventil mit Stutzen ohne Selbstdichtung
- (1) 571/2 - Art. avec raccord non étanche
- (1) 571/2 - Клапан с патрубком без самогерметизации



IVR 571/3 - IVR 571/4



IVR 571/3

IVR 571/4

Reversa con preregolazione, con cappello di regolazione
Reverse valve with presetting and operating plastic cap
Umsteuerungsventil mit Voreinstellung, mit Einstellkappe
À corps inversé avec préreglage, avec chapeau de réglage
Реверсивный термостатический клапан с регулирующим колпачком.

- (1) 571/4 - Art. con bocchettone senza autotenuta
- (1) 571/4 - Item with tail piece without auto-seal
- (1) 571/4 - Art. Ventil mit Stutzen ohne Selbstdichtung
- (1) 571/4 - Art. avec raccord non étanche
- (1) 571/4 - Клапан с патрубком без самогерметизации

Cod./Code	Misura/Size	Attacco/Connection	□/田	€
157105183	1/2"	24-19	10/60	10,46
157105184	1/2"	24-19	10/60	10,10 (1)

IVR 562 - IVR 562/2



IVR 562

IVR 562/2

Dritta con volantino manuale
Straight with manual handle
Gerade mit Handrad
Droit avec volant manuel
Прямой клапан с ручным управлением

- (1) 562/2 - Art. con bocchettone senza autotenuta
- (1) 562/2 - Item with tail piece without auto-seal
- (1) 562/2 - Art. Ventil mit Stutzen ohne Selbstdichtung
- (1) 562/2 - Art. avec raccord non étanche
- (1) 562/2 - Клапан с патрубком без самогерметизации

Cod./Code	Misura/Size	Attacco/Connection	□/田	€
156203180	3/8"	24-19	10/60	9,40
156205180	1/2"	24-19	10/60	9,89
156203160	3/8"	1/2"	10/60	9,20
156205160	1/2"	1/2"	10/60	9,92
156203182	3/8"	24-19	10/60	9,12 (1)
156205182	1/2"	24-19	10/60	9,53 (1)
156203162	3/8"	1/2"	10/60	8,93 (1)
156205162	1/2"	1/2"	10/60	9,09 (1)

IVR 562/3 - IVR 562/4 PREREGOLAZIONE / PRESETTING



IVR 562/3

IVR 562/4

Con preregolazione, dritta con volantino manuale
Straight valve with presetting and with manual handle
Gerade Verschraubung mit Voreinstellung und Handrad
Avec préreglage, equerre avec volant manuel
Прямой клапан для радиаторов с преднастройкой и ручным управлением

- (1) 562/4 - Art. con bocchettone senza autotenuta
- (1) 562/4 - Item with tail piece without auto-seal
- (1) 562/4 - Art. Ventil mit Stutzen ohne Selbstdichtung
- (1) 562/4 - Art. avec raccord non étanche
- (1) 562/4 - Клапан с патрубком без самогерметизации

Cod./Code	Misura/Size	Attacco/Connection	□/田	€
156203183	3/8"	24-19	10/60	9,83
156205183	1/2"	24-19	10/60	10,31
156203163	3/8"	1/2"	10/60	9,62
156205163	1/2"	1/2"	10/60	10,37
156203184	3/8"	24-19	10/60	9,56 (1)
156205184	1/2"	24-19	10/60	9,95 (1)
156203164	3/8"	1/2"	10/60	9,36 (1)
156205164	1/2"	1/2"	10/60	10,01 (1)

IVR 568 - IVR 568/2



Dritta con cappello di regolazione
 Straight valve with operating plastic cap
 Gerade Verschraubung mit Einstellkappe
 Droite avec chapeau de réglage
 Прямой клапан с регулирующим колпачком

Cod./Code	Misura/Size	Attacco/Connection	□/⊕	€
156803180	3/8"	24-19	10/60	8,55
156805180	1/2"	24-19	10/60	9,04
156803160	3/8"	1/2"	10/60	8,34
156805160	1/2"	1/2"	10/60	9,09

- (1) 568/2 - Art. con bocchettone senza autotenuta
- (1) 568/2 - Item with tail piece without auto-seal
- (1) 568/2 - Art. Ventil mit Stutzen ohne Selbstdichtung
- (1) 568/2 - Art. avec raccord non étanche
- (1) 568/2 - Клапан с патрубком без самогерметизации

156803182	3/8"	24-19	10/60	8,28	(1)
156805182	1/2"	24-19	10/60	8,66	(1)
156803162	3/8"	1/2"	10/60	8,08	(1)
156805162	1/2"	1/2"	10/60	8,73	(1)

IVR 568/3 - IVR 568/4 PREREGOLAZIONE / PRESETTING



IVR 568/3

IVR 568/4

Con prerregolazione, dritta con cappello di regolazione
 Straight valve with presetting, operating plastic cap
 Gerade Verschraubung mit Voreinstellung und Einstellkappe
 Avec préréglage, droite avec chapeau de réglage
 Прямой клапан с преднастройкой, регулирующий колпачок

Cod./Code	Misura/Size	Attacco/Connection	□/⊕	€
156803183	3/8"	24-19	10/60	8,97
156805183	1/2"	24-19	10/60	9,46
156803163	3/8"	1/2"	10/60	8,77
156805163	1/2"	1/2"	10/60	9,51

- (1) 568/4 - Art. con bocchettone senza autotenuta
- (1) 568/4 - Item with tail piece without auto-seal
- (1) 568/4 - Art. Ventil mit Stutzen ohne Selbstdichtung
- (1) 568/4 - Art. avec raccord non étanche
- (1) 568/4 - Клапан с патрубком без самогерметизации

156803184	3/8"	24-19	10/60	8,71	(1)
156805184	1/2"	24-19	10/60	9,10	(1)
156803164	3/8"	1/2"	10/60	8,50	(1)
156805164	1/2"	1/2"	10/60	9,15	(1)

VALVOLE PER RADIATORI / RADIATOR VALVES

Valvole termostatiche / Thermostatic valves

SATURN-COAXIAL

Attacco Tubo Ferro



Valvola coassiale termostattabile per radiatori con volantino manuale. Attacchi tubo ferro. Bocchettone con autotenuta. Impieghi: adatte per utilizzo su ogni tipo di radiatore
Thermostatic coaxial valve with plastic cap, iron pipe connection, tail piece with auto-seal. Use: suitable for any type of radiator
Koaxial-Thermostatventil für Heizkörper mit Handrad. Anschlussstutzen mit Selbstdichtung für Eisenrohr. Sie können auf jede Sorte von Heizkörper eingesetzt werden
Vanne coaxiale thermostatisable pour radiateurs avec volant manuel. Fixation tube fer. Raccord avec auto-étanche. Usage: adapté à tout type de radiateur
Коаксиальный термостатический радиаторный клапан с регулирующим пластиковым колпачком. Соединение для стальной трубы. Самогерметизирующийся патрубок. Сфера применения: может устанавливаться на любой тип радиатора

IVR 530 - IVR 530/2



3 vie, attacco tubo ferro, con cappellino di regolazione e autotenuta
3 ways, iron pipe connections, with operating plastic cap and auto-seal
3 Wege, Anschluss für Eisenrohr, mit Einstellkappe und Selbstdichtung
3 voies, fixation tube fer, avec chapeau de réglage et auto-étanche
Трехходовой, соединение для стальной трубы, с регулирующим колпачком и самогерметизацией

Cod./Code	Misura/Size	□/田	€
153003000	3/8"	10/60	10,46
153005000	1/2"	10/40	12,50

(1) 530/2 - Con bocchettone senza autotenuta
(1) 530/2 - Item with tail piece without auto-seal
(1) 530/2 - Artikel Ventil mit rohverschraubung ohne Selbstdichtung
(1) 530/2 - Article avec raccord sans étanche
(1) 530/2 - с накидной гайкой без самогерметизации

153003002	3/8"	10/60	10,00	(1)
153005002	1/2"	10/40	11,90	(1)

IVR 530 AD



Adattatore per tubo PEX/Rame/PEX-AL-PEX
Adapter for PEX, multilayer and copper pipe
PEX, Kupferrohr und Mehrschichtrohr Anschlussadapter
Adaptateur pour tube PEX, multi-couches ou cuivre.
Адаптер для труб: металлопластиковой, медной и PEX

Cod./Code	Misura/Size	Attacco/Connection	□/田	€
153003024	3/8"	24-19	10/150	2,27
153005024	1/2"	24-19	10/150	2,21

VALVOLE PER RADIATORI / RADIATOR VALVES

Valvole termostatiche / Thermostatic valves

JUPITER DETENTORE/LOCKSHIELD - Attacco PEX/Rame/PEX-AL-PEX / PEX/copper/PEX-AL-PEX



Detentore, attacco PEX, multistrato e tubo rame, bocchettone autotenuta, nichelato

Heavy lockshield, PEX, multilayer and copper pipe connection, auto-seal tail piece, nickel plated

Rücklaufverschraubung PEX, Mehrschicht - und Kupferrohr-Anschluss, selbstdichtender Stutzen, vernickelt

Coude de réglage, fixation PEX, multicouche et tube en cuivre, raccord autoétanche, nickelé

Усиленный отсекающий клапан; соединения для трубы PEX, медной и многослойной труб, патрубков с самогерметизацией, никелированный

IVR 557 - IVR 557/2



IVR 557

IVR 557/2

A squadra
Angle lockshield
Eckförmige Rücklaufverschraubung
A équerre
Угловой

Cod./Code	Misura/Size	Attacco/Connection	□/⊞	€
155703180	3/8"	24-19	10/120	5,44
155705180	1/2"	24-19	10/120	7,01
155703160	3/8"	1/2"	10/120	6,64
155705160	1/2"	1/2"	10/120	7,14
155703182	3/8"	24-19	10/120	5,17 (1)
155705182	1/2"	24-19	10/120	6,65 (1)
155703162	3/8"	1/2"	10/120	6,38 (1)
155705162	1/2"	1/2"	10/120	6,78 (1)

- (1) 557/2 - Art. con bocchettone senza autotenuta
- (1) 557/2 - Item with tail piece without auto-seal
- (1) 557/2 - Art. Ventil mit Stutzen ohne Selbstdichtung
- (1) 557/2 - Art. avec raccord non étanche
- (1) 557/2 - Клапан с патрубком без самогерметизации

IVR 555 - IVR 555/2



IVR 555

IVR 555/2

Dritto
Straight lockshield
Gerade Rücklaufverschraubung
Droit
Прямой

Cod./Code	Misura/Size	Attacco/Connection	□/⊞	€
155503180	3/8"	24-19	10/120	6,44
155505180	1/2"	24-19	10/120	8,00
155503160	3/8"	1/2"	10/120	6,51
155505160	1/2"	1/2"	10/120	8,02
155503182	3/8"	24-19	10/120	6,17 (1)
155505182	1/2"	24-19	10/120	7,64 (1)
155503162	3/8"	1/2"	10/120	6,25 (1)
155505162	1/2"	1/2"	10/120	7,66 (1)

- (1) 555/2 - Art. con bocchettone senza autotenuta
- (1) 555/2 - Item with tail piece without auto-seal
- (1) 555/2 - Art. Ventil mit Stutzen ohne Selbstdichtung
- (1) 555/2 - Art. avec raccord non étanche
- (1) 555/2 - Клапан с патрубком без самогерметизации

KIT TERMOSTATICI / THERMOSTATIC KITS



Kit termostatico composto da valvola Saturn, detentore Jupiter e testa termostatica a liquido Sunny

Thermostatic kit: Saturn valve, Jupiter lockshield and Sunny thermostatic head with liquid sensor

Gruppe bestehend aus Thermostatventil Saturn, Rücklaufverschraubung Jupiter und thermostatischem Kopf Sunny

Kit thermostatique composé de vanne Saturn, coude de réglage Jupiter et tête thermostatique avec capteur liquide Sunny

Термостатический комплект состоящий из клапана Saturn, отсекающего вентиля Jupiter и термостатической головки Sunny с жидкостным сенсором.

IVR 567 KIT

NEW



A squadra, per attacco tubo ferro

Angle, iron pipe connection

Eckförmig, Anschluss für Eisenrohr

Équerre, fixation tube en fer

Угловой вентиль, соединение для железной трубы

Cod./Code	Misura/Size	□/田	€
1567K03000	3/8"	1/15	21,63
1567K05000	1/2"	1/15	24,47
1567K07000	3/4"	1/15	30,50

IVR 566 KIT

NEW



Dritto, per attacco tubo ferro

Straight, iron pipe connection

Gerade, Anschluss für Eisenrohr

Droit, fixation tube en fer

Прямой вентиль, соединение для железной трубы

Cod./Code	Misura/Size	□/田	€
1566K03000	3/8"	1/15	22,64
1566K05000	1/2"	1/15	26,52
1566K07000	3/4"	1/15	32,64

IVR 569 KIT

NEW



A squadra, attacco tubo rame, PEX e multistrato

Angle, PEX, multilayer and copper pipe connection

Eckförmig, Anschluss für Kupfer, PEX und Mehrschichtrohr

Équerre, fixation tube en cuivre, PEX et multicouche

Угловой вентиль, соединение для медной, PEX и многослойной трубы

Cod./Code	Misura/Size	Attacco/Connection	□/田	€
1569K03160	3/8"	1/2"	1/15	23,66
1569K05160	1/2"	1/2"	1/15	24,22
1569K03180	3/8"	24-19	1/15	21,62
1569K05180	1/2"	24-19	1/15	24,09

IVR 568 KIT

NEW



Dritto, attacco tubo rame, PEX e multistrato

Straight, PEX, multilayer and copper pipe connection

Gerade, Anschluss für Kupfer, PEX und Mehrschichtrohr

Droit, fixation tube en cuivre, PEX et multicouche

Прямой вентиль, соединение для медной, PEX и многослойной трубы

Cod./Code	Misura/Size	Attacco/Connection	□/田	€
1568K03160	3/8"	1/2"	1/15	23,71
1568K05160	1/2"	1/2"	1/15	25,96
1568K03180	3/8"	24-19	1/15	23,84
1568K05180	1/2"	24-19	1/15	25,89

IVR 570 KIT

NEW



A squadra, per attacco tubo ferro
 Angle, iron pipe connection
 Eckförmig, Anschluss für Eisenrohr
 Équerre, fixation tube en fer
 Угловой вентиль, соединение для железной трубы

Cod./Code	Misura/Size	□/田	€
1570K05000	1/2"	1/15	26,26

IVR 571 KIT

NEW



A squadra, attacco tubo rame, PEX e multistrato
 Angle, PEX, multilayer and copper pipe connection
 Eckförmig, Anschluss für Kupfer, PEX und Mehrschichtrohr
 Équerre, fixation tube en cuivre, PEX et multicouche
 Угловой вентиль, соединение для медной, PEX и многослойной трубы

Cod./Code	Misura/Size	Attacco/Connection	□/田	€
1571K05180	1/2"	24-19	1/15	26,04

IVR 436



Kit valvole termostattizzabili a squadra per tubo rame, PEX e multistrato, composto da: valvola SATURN e detentore JUPITER, volantino manuale, 2+2 DX/SX riduzioni con guarnizione, valvola scarico aria, tappo ottone con cappuccio bianco

Thermostatic angle radiator valve kit for copper, PEX and multilayer pipe, includes: SATURN radiator valve and JUPITER lockshield, manual handle, 2+2 DX/SX reductions, manual air vent valve, brass plug with white plastic cap

KIT (Garnitur) Thermostatventile, eckförmig für Kupfer-, PEX- und Mehrschichtrohr, bestehend aus: Ventil SATURN und Rücklaufverschraubung JUPITER, Handrad, 2+2 Reduzierstücke rechts/links mit Dichtung, Entlüftungsventil, Messingdeckel mit weißer Kappe

Kit vannes thermostatizables équerre pour tube en cuivre, PEX et multicouche, composé de: vanne SATURN et coude de réglage JUPITER, volant manuel, 2+2 DX/SX réductions avec joint, vanne évacuation aria, bouchon en laiton avec capuchon blanc

Комплект термостатических угловых клапанов для медной, многослойной и трубы PEX включает: радиаторный клапан Saturn и отсекающий клапан Jupiter, 2 + 2 пр./лев. футорки с прокладками, ручной воздухоотводчик, заглушки из латуни с белым пластиковыми колпачками

Cod./Code	Misura/Size	Attacco/Connection	□/田	€
143603682	3/8"	24-19	1/7	23,76
143605682	1/2"	24-19	1/7	26,55

VALVOLE TERMOSTATICHE / THERMOSTATIC VALVES

Componenti e ricambi / Components and spare parts



IVR 458



Vitone per valvola termostatica
TRV bonnet
Einsatz für Thermostatventil im Verteiler
Mécanisme pour robinetterie thermostatizable
Вставка для термостатического клапана

Cod./Code	Misura/Size		□/田	€
145800005	1/2"	VITONE VAL TERMOST COMPL	50/600	2,62
145800006	3/4"	VITONE VAL TERMOST COMPL	50/600	2,97
145800020	1"	VITONE TERM COLL INX ASS	50/300	3,90
145800115	1/2"	VITONE PRE-REGOLAZ COMPL	50/600	2,87
145800117	3/4"	VITONE PRE-REGOLAZ COMPL	50/600	3,27
145800155	1/2"	VITONE TERM FLUSSO INVERSO / REVERSE FLOW	50/600	4,80
145800157	3/4"	VITONE TERM FLUSSO INVERSO / REVERSE FLOW	50/600	5,39
145800165	1/2"	VITONE TERM PRE-REG FLUSSO INVERSO / PRESET-REVERSE FLOW	50/600	4,86
145800167	3/4"	VITONE TERM PRE-REG FLUSSO INVERSO / PRESET-REVERSE FLOW	50/600	5,51

IVR 459



Chiave per sostituire vitone
Allen key for bonnets replacement
Montageblock für den Austausch (von Thermostatventil-Innenteilen unter Druck)
Clef pour changement du mécanisme
Ключ для замены кран-буксы без слива системы

Cod./Code	Misura/Size	□/田	€
338300171		1/6	356,88

IVR 457



Adattatore per montaggio testa termostatica DNF
 Adapter for mounting DNF thermostatic head
 Adapter für den Thermostatkopf DNF
 Adaptateur pour le montage de la tête thermostatique DNF
 Адаптер для монтажа термостатической головки DNF

Cod./Code	Misura/Size	□/田	€
145700500		10/500	0,35

IVR 324



Bocchettone per Saturn e Mercury - Con autotenuta
 Tail piece for Saturn e Mercury - with auto-seal
 Rohrverschraubung für Saturn und Mercury - mit Selbstdichtung
 Raccord pour Saturn et Mercury - avec autoétanche
 Самогерметизирующий патрубок для моделей Saturn и Mercury

Cod./Code	Misura/Size	□/田	€
132403051	3/8" x 1/2"	20/240	2,08
132405071	1/2" x 3/4"	20/240	2,66
132407101	3/4" x 1"	10/120	4,25

IVR 326



Bocchettone per Saturn e Mercury senza autotenuta - (codolo + calotta)
 Tail piece for Saturn e Mercury with auto-seal (tail piece and nut)
 Rohrverschraubung für Saturn und Mercury mit Selbstdichtung (Verschraubung und Nuss)
 Raccord pour Saturn et Mercury avec autoétanche (queue et calotte)
 Патрубок без самогерметизации для моделей Saturn и Mercury (хвостовая часть с гайкой)

Cod./Code	Misura/Size	□/田	€
132603051	3/8" x 1/2"	10/120	2,01
132605071	1/2" x 3/4"	20/240	2,46
132607101	3/4" x 1"	10/120	3,47
132610121	1" x 1"1/4"	10/60	5,70

IVR 325



Bocchettone telescopico, nichelato
 Telescopic tail piece, nickel- plated
 Anschluss-Stutzen teleskopisch - vernickelt
 Raccord télescopique - nickelé
 Телескопическое соединение, никелированное

Cod./Code	Misura/Size	□/田	€
132503051	3/8" x 1/2"	20/400	2,20
132505071	1/2" x 3/4"	10/200	3,13
132507101	3/4" x 1"	5/100	5,54

IVR 594



Volantino manuale. ABS colore RAL 9010 - per SATURN, AVANT FLOOR, IVR INOX
Manual handle. ABS Ral 9010 colour - for SATURN, AVANT FLOOR, IVR INOX
ABS Handrad, RAL9010 - für SATURN, AVANT FLOOR, IVR INOX
Volant manuel ABS couleur RAL 9010 - pour SATURN, AVANT FLOOR, IVR INOX
Колпачок для ручной регулировки, ABS цвет Ral 9010 - для SATURN, AVANT FLOOR, IVR INOX.

Cod./Code	Misura/Size	□/⊞	€
159400001	M30 x 1.5	10/120	1,43

IVR 596



Cappellotto di regolazione per SATURN, AVANT FLOOR, IVR INOX - ABS Colore RAL 9010
Operating plastic cap for SATURN, AVANT FLOOR, IVR INOX - ABS Ral 9010 colour
ABS Einstellkappe für SATURN, AVANT FLOOR, IVR INOX - RAL 9010
Chapeau de réglage pour SATURN, AVANT FLOOR, IVR INOX - ABS Couleur RAL 9010
Регулирующий колпачок для SATURN, AVANT FLOOR, IVR INOX - ABS цвет Ral 9010

Cod./Code	Misura/Size	□/⊞	€
159600001	M30 x 1.5	20/360	0,38

IVR 588



Cappuccio per detentori JUPITER - ABS colore RAL 9010
Plug for lockshield JUPITER - ABS colour Ral 9010
Kappe für Rücklaufverschraubungen JUPITER - ABS RAL 9010
Capuchon pour coudes de réglages JUPITER - ABS couleur RAL 9010
Колпачок для отсекающего клапана JUPITER - ABS цвет RAL 9010

Cod./Code	Misura/Size	□/⊞	€
158803001	3/8"	10/240	0,51
158805001	1/2"	10/240	0,56
158805001	3/4"	10/240	0,56

IVR 595



Anello anti manomissione
Anti-temper ring
Ring - abschließbar
Anneau contre sabotage
Защитное кольцо

Cod./Code	Misura/Size	□/⊞	€
159500001	M30 x 1,5	10/40	8,48



VALVOLE PER RADIATORI / RADIATOR VALVES

Valvole manuali / Manuale valves

MERCURY - Attacco tubo ferro / Iron pipe connection

Valvola manuale per radiatori, attacco tubo ferro, bocchettone con/senza autotenuta, nichelata
Manual radiator valve, iron pipe connection, with/without auto-seal tail piece, nickel plated
Manuelles Heizkörperventil, Anschluss für Eisenrohr, Stutzen mit/ohne Selbstdichtung - vernickelt
Robinet manuel pour radiateurs, fixation tube fer, raccord autoétanche ou non étanche - nickelée
Ручной радиаторный клапан, соединение для стальной трубы, с патрубком с/без самогерметизации

IVR 536 - IVR 536/2



IVR 536

IVR 536/2

A squadra con volantino manuale
Angle valve with manual handle
Eckförmig mit Handrad
Equerre avec volant manuel
Угловой клапан с ручным управлением

Cod./Code	Misura/Size	□/⊞	€	
153603000	3/8"	10/60	5,73	
153605000	1/2"	10/60	6,86	
153607000	3/4"	10/40	9,37	
153603002	3/8"	10/60	5,46	(1)
153605002	1/2"	10/60	6,50	(1)
153607002	3/4"	10/40	8,44	(1)

- (1) 536/2 - Art. con bocchettone senza autotenuta
- (1) 536/2 - Item with tail piece without auto-seal
- (1) 536/2 - Art. Ventil mit Stutzen ohne Selbstdichtung
- (1) 536/2 - Art. avec raccord non étanche
- (1) 536/2 - Клапан с патрубком без самогерметизации

IVR 534 - IVR 534/2



IVR 534

IVR 534/2

Dritta con volantino manuale
Straight with manual handle
Gerade mit Handrad
Droit avec Volant manuel
Прямой клапан с ручным управлением

Cod./Code	Misura/Size	□/⊞	€	
153403000	3/8"	10/60	6,15	
153405000	1/2"	10/60	7,27	
153407000	3/4"	10/40	10,24	
153403002	3/8"	10/60	5,88	(1)
153405002	1/2"	10/60	6,91	(1)
153407002	3/4"	10/40	9,31	(1)

- (1) 534/2 - Art. con bocchettone senza autotenuta
- (1) 534/2 - Item with tail piece without auto-seal
- (1) 534/2 - Art. Ventil mit Stutzen ohne Selbstdichtung
- (1) 534/2 - Art. avec raccord non étanche
- (1) 534/2 - Клапан с патрубком без самогерметизации

VALVOLE PER RADIATORI / RADIATOR VALVES

Valvole manuali / Manuale valves

MERCURY - Detentore attacco tubo ferro / Lockshield iron pipe connection



Detentore per radiatori, attacco tubo ferro, bocchettone con/senza autotenuta, nichelato
Lockshield, iron pipe connection, with/without auto-seal tail piece, nickel plated
Rücklaufverschraubung für Heizkörper, Anschluss für Eisenrohr, Stutzen mit/ohne Selbstdichtung, vernickelt
Coudes de réglages pour radiateurs, fixation tube fer, raccord autoétanche ou non étanche, nickelée
Отсекающий клапан для радиаторов, соединения для стальной трубы, патрубков с/без уплотнения, никелированный

IVR 537 - IVR 537/2



IVR 537

IVR 537/2

A squadra, con autotenuta
Angle valve with auto-seal tail piece
Eckförmig und selbstdichtend
A équerre avec autoétanche
Угловой клапан, патрубок с самогерметизацией

Cod./Code	Misura/Size	□/田	€
153703000	3/8"	10/120	4,93
153705000	1/2"	10/120	5,95
153707000	3/4"	10/60	8,60

- (1) 537/2 - Art. con bocchettone senza autotenuta
- (1) 537/2 - Item with tail piece without auto-seal
- (1) 537/2 - Art. Ventil mit Stutzen ohne Selbstdichtung
- (1) 537/2 - Art. avec raccord non étanche
- (1) 537/2 - Клапан с патрубком без самогерметизации

153703002	3/8"	10/120	4,67	(1)
153705002	1/2"	10/120	5,59	(1)
153707002	3/4"	10/60	7,68	(1)

IVR 535 - IVR 535/2



IVR 535

IVR 535/2

Dritto, con autotenuta
Straight, with auto-seal tail piece
Gerade und selbstdichtend
Droite, avec autoétanche
Прямой отсекающий клапан с самогерметизацией

Cod./Code	Misura/Size	□/田	€
153503000	3/8"	10/120	5,35
153505000	1/2"	10/120	6,50
153507000	3/4"	10/60	9,40

- (1) 535/2 - Art. con bocchettone senza autotenuta
- (1) 535/2 - Item with tail piece without auto-seal
- (1) 535/2 - Art. Ventil mit Stutzen ohne Selbstdichtung
- (1) 535/2 - Art. avec raccord non étanche
- (1) 535/2 - Клапан с патрубком без самогерметизации

153503002	3/8"	10/120	5,09	(1)
153505002	1/2"	10/120	6,14	(1)
153507002	3/4"	10/60	8,48	(1)



VALVOLE PER RADIATORI / RADIATOR VALVES

Valvole manuali / Manuale valves

MERCURY PLUS - Ispezionabili/Unscrewable - Attacco tubo ferro / Iron pipe connection

Valvola ispezionabile manuale a squadra per radiatori, attacco tubo ferro, bocchettone con/senza autotenuta, nichelata

Angle manual radiators valve, iron pipe connection, with/without auto-seal tail piece, nickel plated

Eckförmiges inspektionierbar manuelles Heizkörperventil, Anschluss für Eisenrohr, Stutzen mit/ohne Selbstdichtung, vernickelt

Vanne contrôlable manuelle équerre pour radiateurs, fixation à souder pour tube en cuivre, raccord autoétanche ou non étanche, nickelée

Ручной радиаторный клапан, соединение для стальной трубы, патрубок с/без самогерметизации, никелированный

IVR 548 - IVR 548/2



IVR 548



IVR 548/2

A squadra con volantino manuale

Angle valve with manual handle

Eckförmig mit Handrad

Equerre avec volant manuel

Угловой клапан с ручным управлением

(1) 548/2 - Art. con bocchettone senza autotenuta

(1) 548/2 - Item with tail piece without auto-seal

(1) 548/2 - Art. Ventil mit Stutzen ohne Selbstdichtung

(1) 548/2 - Art. avec raccord non étanche

(1) 548/2 - Клапан с патрубком без самогерметизации



Cod./Code	Misura/Size	□/田	€
154805000	1/2"	10/60	7,51
154807000	3/4"	10/60	9,95
154805002	1/2"	10/60	7,15
154807002	3/4"	10/60	9,02

(1)

(1)

IVR 546 - IVR 546/2



IVR 546



IVR 546/2

Dritta con volantino manuale

Straight with manual handle

Gerade mit Handrad

Droit avec volant manuel

Прямой клапан с ручным управлением

(1) 546/2 - Art. con bocchettone senza autotenuta

(1) 546/2 - Item with tail piece without auto-seal

(1) 546/2 - Art. Ventil mit Stutzen ohne Selbstdichtung

(1) 546/2 - Art. avec raccord non étanche

(1) 546/2 - Клапан с патрубком без самогерметизации



Cod./Code	Misura/Size	□/田	€
154605000	1/2"	10/60	8,02
154607000	3/4"	10/40	10,79
154605002	1/2"	10/60	7,66
154607002	3/4"	10/40	9,85

(1)

(1)

VALVOLE PER RADIATORI / RADIATOR VALVES

Valvole manuali / Manuale valves

MERCURY PLUS - Detentore attacco tubo ferro / Lockshield iron pipe connection



Detentore ispezionabile a squadra per radiatori, attacco tubo ferro, bocchettone con/senza autotenuta, nichelata
Angle lockshield, iron pipe connection, with/without auto-seal tail piece, nickel plated
Eckförmiges Rücklaufverschraubung, inspektionierbar, für Heizkörper, Anschluss für Kupferrohr, Stutzen mit/ohne Selbstdichtung, vernickelt
Coude de réglage controlable étanche, fixation à souder pour tube en cuivre, raccord autoétanche ou non étanche, nickelée
Отсекающий угловой клапан, соединения для стальной трубы, патрубок с / без самогерметизации, никелированный

IVR 549 - IVR 549/2



A squadra
Angle lockshield
Eckförmige Rücklaufverschraubung
A équerre
Угловой клапан

IVR 549

IVR 549/2

- (1) 549/2 - Art. con bocchettone senza autotenuta
(1) 549/2 - Item with tail piece without auto-seal
(1) 549/2 - Art. Ventil mit Stutzen ohne Selbstdichtung
(1) 549/2 - Art. avec raccord non étanche
(1) 549/2 - Клапан с патрубком без самогерметизации

Cod./Code	Misura/Size	□/田	€
154905000	1/2"	10/120	6,21
154907000	3/4"	10/60	8,92
154905002	1/2"	10/120	5,85 (1)
154907002	3/4"	10/60	7,98 (1)

IVR 547 - IVR 547/2



Dritto
Straight lockshield
Gerade Rücklaufverschraubung
Droit
Прямой клапан

IVR 547

IVR 547/2

- (1) 547/2 - Art. con bocchettone senza autotenuta
(1) 547/2 - Item with tail piece without auto-seal
(1) 547/2 - Art. Ventil mit Stutzen ohne Selbstdichtung
(1) 547/2 - Art. avec raccord non étanche
(1) 547/2 - Клапан с патрубком без самогерметизации

Cod./Code	Misura/Size	□/田	€
154705000	1/2"	10/120	6,74
154707000	3/4"	10/60	9,74
154705002	1/2"	10/120	6,38 (1)
154707002	3/4"	10/60	8,81 (1)



VALVOLE PER RADIATORI / RADIATOR VALVES

Valvole manuali / Manuale valves

MERCURY - Attacco PEX/Rame/PEX-AL-PEX / PEX/copper/PEX-AL-PEX

Valvola manuale per radiatori, attacco PEX, multistrato e tubo rame, bocchettone con/senza autotenuta, nichelata
Manual valve for radiators, PEX, multilayer and copper pipe connection, tail piece with/without auto-seal, nickel-plated
Handventil für Heizkörper, PEX, Mehrschicht- und Kupferrohr-Anschluss, Rohrverschraubung mit/ohne Selbstdichtung, vernickelt
Vanne manuelle pour radiateurs, fixation PEX, multicouche et tube en cuivre, raccord avec/sans auto-étanche, nickelée
Ручной радиаторный клапан, соединения для: PEX, многослойной и медной трубы, патрубков с / без самогерметизации, никелированный

IVR 540 - IVR 540/2



IVR 540

IVR 540/2

- (1) 540/2 - Art. con bocchettone senza autotenuta
- (1) 540/2 - Item with tail piece without auto-seal
- (1) 540/2 - Art. Ventil mit Stutzen ohne Selbstdichtung
- (1) 540/2 - Art. avec raccord non étanche
- (1) 540/2 - Клапан с патрубком без самогерметизации

A squadra con volantino manuale
Angle valve with manual handle
Eckförmig mit Handrad
Equerre avec volant manuel
Угловой клапан с ручным управлением

Cod./Code	Misura/Size	Attacco/Connection	□/田	€	
154003180	3/8"	24-19	10/60	5,89	
154005180	1/2"	24-19	10/60	6,57	
154003160	3/8"	1/2"	10/60	5,57	
154005160	1/2"	1/2"	10/60	6,41	
154003182	3/8"	24-19	10/60	5,62	(1)
154005182	1/2"	24-19	10/60	6,21	(1)
154003162	3/8"	1/2"	10/60	5,30	(1)
154005162	1/2"	1/2"	10/60	6,05	(1)

IVR 538 - IVR 538/2



IVR 538

IVR 538/2

- (1) 538/2 - Art. con bocchettone senza autotenuta
- (1) 538/2 - Item with tail piece without auto-seal
- (1) 538/2 - Art. Ventil mit Stutzen ohne Selbstdichtung
- (1) 538/2 - Art. avec raccord non étanche
- (1) 538/2 - Клапан с патрубком без самогерметизации

Dritta con volantino manuale
Straight with manual handle
Gerade mit Handrad
Droite avec volant manuel
Прямой клапан с ручным управлением

Cod./Code	Misura/Size	Attacco/Connection	□/田	€	
153803180	3/8"	24-19	10/60	6,11	
153805180	1/2"	24-19	10/60	8,64	
153803160	3/8"	1/2"	10/60	7,42	
153805160	1/2"	1/2"	10/60	8,12	
153803182	3/8"	24-19	10/60	5,85	(1)
153805182	1/2"	24-19	10/60	8,28	(1)
153803162	3/8"	1/2"	10/60	7,15	(1)
153805162	1/2"	1/2"	10/60	7,84	(1)



VALVOLE PER RADIATORI / RADIATOR VALVES

Valvole manuali / Manuale valves

MERCURY - Detentore attacco PEX/Rame/PEX-AL-PEX / Lockshield PEX/copper/PEX-AL-PEX

Detentore a squadra per radiatori, attacco tubo rame, bocchettone con/senza autotenuta, nichelata
Angle lockshield, copper connection, with/without auto-seal tail piece, nickel plated
Eckförmiges, inspektionierbar, für Heizkörper, Anschluss für Kupferrohr, Stutzen mit/ohne Selbstdichtung, vernickelt
Coude de réglage étanche, fixation à souder pour tube en cuivre, raccord autoétanche ou non étanche, nickelée
Угловой отсекающий клапан, соединения для стальной трубы, патрубком С / без самогерметизации, никелированный

IVR 541 - IVR 541/2



A squadra
Angle lockshield
Eckförmige Rücklaufverschraubung
Equerre avec volant manuel
Угловой клапан

IVR 541

IVR 541/2

- (1) 541/2 - Art. con bocchettone senza autotenuta
- (1) 541/2 - Item with tail piece without auto-seal
- (1) 541/2 - Art. Ventil mit Stutzen ohne Selbstdichtung
- (1) 541/2 - Art. avec raccord non étanche
- (1) 541/2 - Клапан с патрубком без самогерметизации

Cod./Code	Misura/Size	Attacco/Connection	□/⊕	€	
154103180	3/8"	24-19	10/120	5,12	
154105180	1/2"	24-19	10/120	5,78	
154103160	3/8"	1/2"	10/120	4,77	
154105160	1/2"	1/2"	10/120	5,60	
154103182	3/8"	24-19	10/120	4,85	(1)
154105182	1/2"	24-19	10/120	5,42	(1)
154103162	3/8"	1/2"	10/120	4,51	(1)
154105162	1/2"	1/2"	10/120	5,24	(1)

IVR 539 - IVR 539/2



Dritto
Straight lockshield
Gerade Rücklaufverschraubung
Droit
Прямой клапан

IVR 539

IVR 539/2

- (1) 539/2 - Art. con bocchettone senza autotenuta
- (1) 539/2 - Item with tail piece without auto-seal
- (1) 539/2 - Art. Ventil mit Stutzen ohne Selbstdichtung
- (1) 539/2 - Art. avec raccord non étanche
- (1) 539/2 - Клапан с патрубком без самогерметизации

Cod./Code	Misura/Size	Attacco/Connection	□/⊕	€	
153903180	3/8"	24-19	10/120	5,26	
153905180	1/2"	24-19	10/120	7,83	
153903160	3/8"	1/2"	10/120	6,57	
153905160	1/2"	1/2"	10/120	7,43	
153903182	3/8"	24-19	10/120	5,00	(1)
153905182	1/2"	24-19	10/120	7,47	(1)
153903162	3/8"	1/2"	10/120	6,31	(1)
153905162	1/2"	1/2"	10/120	7,07	(1)



VALVOLE PER RADIATORI / RADIATOR VALVES

Valvole manuali / Manuale valves
MARS

IVR 505 - IVR 505/2

NEW



IVR 505



IVR 505/2



LOTTO MINIMO
 MINIMUM BATCH

- (1) 505/2 - Art. con bocchettone senza autotenuta
- (1) 505/2 - Item with tail piece without auto-seal
- (1) 505/2 - Art. Ventil mit Stutzen ohne Selbstdichtung
- (1) 505/2 - Art. avec raccord non étanche
- (1) 505/2 - Клапан с патрубком без самогерметизации

Mars, valvola manuale per radiatori, a squadra, attacco tubo ferro, bocchettone con autotenuta, nichelata

Mars, angle manual radiator valve, iron pipe connection, with auto-seal tail piece, nickel plated

Mars, eckförmiges Handventil für Heizkörper, Anschluss für Eisenrohr, Stutzen mit Selbstdichtung - vernickelt Mercury

Mars, robinet manuel équerre pour radiateurs, fixation tube fer, raccord autoétanche - nickelée

Mars, ручной радиаторный клапан угловой, соединение для стальной трубы, патрубков с самогерметизацией, никелированный

Cod./Code	Misura/Size	□/田	€	
150503000	3/8"	10/60	6,38	
150505000	1/2"	10/60	6,38	
150503002	3/8"	10/60	6,00	(1)
150505002	1/2"	10/60	6,00	(1)

IVR 506 - IVR 506/2

NEW



IVR 506



IVR 506/2



LOTTO MINIMO
 MINIMUM BATCH

- (1) 506/2 - Art. con bocchettone senza autotenuta
- (1) 506/2 - Item with tail piece without auto-seal
- (1) 506/2 - Art. Ventil mit Stutzen ohne Selbstdichtung
- (1) 506/2 - Art. avec raccord non étanche
- (1) 506/2 - Клапан с патрубком без самогерметизации

Mars, detentore per radiatori, a squadra, attacco tubo ferro, bocchettone con autotenuta, nichelato

Mars, angle lockshield, iron pipe connection, with auto-seal tail piece, nickel plated

Mars, eckförmige Rücklaufverschraubung für Heizkörper, Anschluss für Eisenrohr, Stutzen mit Selbstdichtung, vernickelt

Mars, coude de réglage pour radiateurs, équerre, fixation tube fer, raccord autoétanche, nickelée

Mars, угловой отсекающий клапан для радиаторов, соединения для стальной трубы, патрубков с уплотнения, никелированный

Cod./Code	Misura/Size	□/田	€	
150603000	3/8"	1/120	5,63	
150605000	1/2"	1/120	5,63	
150603002	3/8"	1/120	5,25	(1)
150605002	1/2"	1/120	5,25	(1)



IVR 508 - IVR 508/2



IVR 508

IVR 508/2



LOTTO MINIMO
MINIMUM BATCH

- (1) 508/2 - Art. con bocchettone senza autotenuta
- (1) 508/2 - Item with tail piece without auto-seal
- (1) 508/2 - Art. Ventil mit Stutzen ohne Selbstdichtung
- (1) 508/2 - Art. avec raccord non étanche
- (1) 508/2 - Клапан с патрубком без самогерметизации

Mars, valvola manuale per radiatori, a squadra, attacco tubo rame, bocchettone con autotenuta, nichelata
Mars, angle manual radiator valve, copper connection, with auto-seal tail piece, nickel plated
Mars, eckförmiges, Handventil für Heizkörper, Anschluss für Kupferrohr, Stutzen mit Selbstdichtung, vernickelt
Mars, robinet manuel pour radiateurs, équerre, fixation tube cuivre, raccord autoétanche - nickelée
Mars, ручной радиаторный клапан,угловой,соединения для медной трубы, патрубков с самогерметизацией, никелированный

Cod./Code	Misura/Size	Attacco/Connection	□/田	€	
150803160	3/8"	1/2"	10/60	5,36	
150805160	1/2"	1/2"	10/60	6,11	
150803162	3/8"	1/2"	10/60	5,10	(1)
150805162	1/2"	1/2"	10/60	5,74	(1)

IVR 510 - IVR 510/2



IVR 510

IVR 510/2



LOTTO MINIMO
MINIMUM BATCH

- (1) 510/2 - Art. con bocchettone senza autotenuta
- (1) 510/2 - Item with tail piece without auto-seal
- (1) 510/2 - Art. Ventil mit Stutzen ohne Selbstdichtung
- (1) 510/2 - Art. avec raccord non étanche
- (1) 510/2 - Клапан с патрубком без самогерметизации

Mars, detentore per radiatori, a squadra, attacco tubo rame, bocchettone con autotenuta, nichelato
Mars, angle lockshield, copper connection, with auto-seal tail piece, nickel plated
Mars, eckförmige Rücklaufverschraubung für Heizkörper, Anschluss für Kupferrohr, Stutzen mit Selbstdichtung, vernickelt
Mars, coude de réglage pour radiateurs, équerre, fixation tube cuivre, raccord autoétanche ou non étanche, nickelée
Mars, угловой отсекающий клапан,соединения для медной трубы, патрубков с самогерметизации, никелированный

Cod./Code	Misura/Size	Attacco/Connection	□/田	€	
151003160	3/8"	1/2"	1/120	4,73	
151005160	1/2"	1/2"	1/120	5,44	
151003162	3/8"	1/2"	1/120	4,50	(1)
151005162	1/2"	1/2"	1/120	5,06	(1)



VALVOLE MANUALI / MANUAL VALVES

Componenti e ricambi / Components and spare parts

IVR 324



Bocchettone per Saturn e Mercury - Con autotenuta
Tail piece for Saturn e Mercury - with auto-seal
Rohrverschraubung für Saturn und Mercury - mit Selbstdichtung
Raccord pour Saturn et Mercury - avec autoétanche
Самогерметизирующий патрубок для моделей Saturn и Mercury

Cod./Code	Misura/Size	□/⊕	€
132403051	3/8" x 1/2"	20/240	2,08
132405071	1/2" x 3/4"	20/240	2,66
132407101	3/4" x 1"	10/120	4,25

IVR 326



Bocchettone per Saturn e Mercury senza autotenuta - (codolo + calotta)
Tail piece for Saturn e Mercury with auto-seal (tail piece and nut)
Rohrverschraubung für Saturn und Mercury mit Selbstdichtung (Verschraubung und Nuss)
Raccord pour Saturn et Mercury avec autoétanche (queue et calotte)
Патрубок без самогерметизации для моделей Saturn и Mercury (хвостовая часть с гайкой)

Cod./Code	Misura/Size	□/⊕	€
132603051	3/8" x 1/2"	20/240	2,01
132605071	1/2" x 3/4"	20/240	2,46
132607101	3/4" x 1"	10/120	3,47
132610121	1" x 1"1/4	10/160	5,70

IVR 325



Bocchettone telescopico, nichelato
Telescopic tail piece, nickel- plated
Anschluss-Stutzen teleskopisch - vernickelt
Raccord télescopique - nickelé
Телескопическое соединение, никелированное

Cod./Code	Misura/Size	□/⊕	€
132503051	3/8"	20/400	2,20
132505071	1/2"	10/200	3,13
132507101	3/4"	5/100	5,54

IVR 590



Volantino manuale ABS colore RAL 9010 - per MERCURY, AVANT FLOOR
ABS manual handle Ral 9010 colour - for MERCURY, AVANT FLOOR
ABS Handrad, RAL9010 - für MERCURY, AVANT FLOOR
Volant manuel ABS couleur RAL 9010 - pour MERCURY, AVANT FLOOR -
Колпачок для ручной регулировки, ABS цвет Ral 9010 - для MERCURY, AVANT FLOOR

Cod./Code	Misura/Size	□/⊞	€
159000002	3/8" - 1/2"	10/180	0,67

IVR 586



Cappuccio per detentori - Per detentori MERCURY - MERCURY PLUS - Ottone nichelato
Plug for MERCURY lockshield - MERCURY PLUS - nickel-plated brass
Kappe für Rücklaufverschraubungen MERCURY - MERCURY PLUS - aus vernickeltem Messing
Capuchon pour coude de réglage MERCURY - MERCURY PLUS - en laiton nickélé
Заглушка для отсекающего клапана MERCURY - MERCURY PLUS из латуни, никелированная

Cod./Code	Misura/Size	□/⊞	€
158600001	3/8" - 1/2" - 3/4"	10/240	0,62

IVR 587



Cappuccio per detentori - Per detentori MERCURY - ABS colore Ral 9010
Plug for Lockshield - For lockshields MERCURY - ABS color Ral 9010
Kappe für Rücklaufverschraubung MERCURY - ABS Farbe Ral 9010
Capuchon pour coudes de réglage MERCURY - ABS couleur RAL 9010
Крышка для отсекающего клапана MERCURY - ABS, цвет Ral 9010

Cod./Code	Misura/Size	□/⊞	€
158700001	3/8" - 1/2"	10/240	0,30

IVR 435



Kit valvole manuali a squadra per tubo rame, PEX e multistrato, composto da: valvola e detentore MERCURY, 2+2 DX/SX riduzioni con guarnizione siliconica, valvola scarico aria, tappo ottone con cappuccio bianco

Manual angle radiator valve kit for copper, PEX and multilayer pipe, includes: MERCURY radiator valve and lockshield, 2+2 DX/SX reductions with silicone gasket, manual air vent valve, brass plug with white plastic cap

KIT (Garnitur) manuelles Heizkörperventile, eckförmig für Kupfer-, PEX - und Mehrschichtrohr, bestehend aus: Ventil und Rücklaufverschraubung MERCURY, 2+2 rechts/links, Reduzierstücke mit Silikondichtung, Luftablassventil, Messingdeckel mit weißer Kappe

Kit vannes manuelles équerre pour tube en cuivre, PEX et multicouche, composé de: vanne et coude de réglage MERCURY, 2+2 DX/SX réductions avec joint silicone, vanne d'évacuation de l'air, bouchon en laiton avec capuchon blanc

Комплект ручных угловых клапанов для медной, многослойной и трубы PEX включает: радиаторный клапан и отсекающий клапан Mercury, 2 + 2 пр./лев. футорки с силиконовыми прокладками, ручной воздухоотводчик, заглушки из латуни с белыми пластиковыми колпачками.

Cod./Code	Misura/Size	Attacco/Connection	□/田	€
143503682	3/8"	24-19	1/7	20,38
143505682	1/2"	24-19	1/7	21,85

IVR 437



Kit universale per radiatori alluminio 1" flangia Ø 42 RAL 9010 composto da: n° 2 DX + n° 2 SX riduzioni con guarnizione siliconica, valvola scarico aria, tappo ottone con cappuccio bianco

Universal kit for aluminum radiators 1" series, Ø 42 flange RAL 9010 includes: n° 2 DX + n° 2 SX reductions with silicone gasket, manual air vent valve, brass plug with white plastic cap

Universalgarnitur für Aluheizkörper, 1" Flansch, Ø 42 RAL 9010, bestehend aus: 2 rechten + 2 linken Reduzierstücke mit Silikondichtung, Entlüftungsventil, Messingdeckel mit weißer Kappe

Kit universel pour radiateurs aluminium 1" bride Ø 42 RAL 9010 composé de: n° 2 DX + n° 2 SX réductions avec joint silicone, vanne d'évacuation de l'air, bouchon en laiton avec capuchon blanc

Универсальный набор для алюминиевых радиаторов 1", фланец Ø 42, RAL 9010 состоящий из: 2+2 пр./лев. футорки с силиконовыми прокладками, воздухоотводчиком, заглушка из латуни с белым пластиковым колпачком

Cod./Code	Misura/Size	Attacco/Connection	□/田	€
143710673	1"	3/8"	1/5	6,85
143710675	1"	1/2"	1/5	6,85

IVR 438



Kit universale per radiatori alluminio 1" flangia Ø 42 RAL 9010 composto da: n° 2 DX + n° 2 SX riduzioni con guarnizione siliconica, valvola scarico aria, tappo ottone con cappuccio bianco

Universal kit for aluminum radiators 1" series, Ø 42 flange RAL 9010 includes: n° 2 DX + n° 2 SX reductions with silicone gasket, manual air vent valve, brass plug with white plastic cap

Universalgarnitur für Aluheizkörper, 1" Flansch, Ø 42 RAL 9010, bestehend aus: 2 rechten + 2 linken Reduzierstücke mit Silikondichtung, Entlüftungsventil, Messingdeckel mit weißer Kappe

Kit universel pour radiateurs en aluminium 1" bride Ø 42 RAL 9010 composé de: n° 2 DX + n° 2 SX réductions avec joint de silicone, vanne d'évacuation de l'air, bouchon en laiton avec chapeau blanc, couple de supports

Универсальный набор для алюминиевых радиаторов 1", фланец Ø 42, RAL 9010 состоящий из: 2+2 пр./лев. футорки с силиконовыми прокладками, ручной воздухоотводчик, заглушки из латуни с белыми пластиковыми колпачками

Cod./Code	Misura/Size	Attacco/Connection	□/田	€
143810673	1"	3/8"	1/5	7,37
143810675	1"	1/2"	1/5	8,38

VALVOLE PER RADIATORI / RADIATOR VALVES

Valvole H / H valves



IVR 753



Valvola "H" con attacco M per impianti bitubo con derivazioni a parete
 "H" valve with male connection for double pipe systems with wall pipes
 Zweirohr-Hahnblock Eckform mit AG-Anschluß
 Pièce "H" avec embout mâle pour systèmes bitube avec dérivation murales
 Клапан "H" с наружной резьбой, для двухтрубных систем, с возможностью монтажа в стену

Cod./Code	Misura/Size	□/田	€
175307001	3/4"	6/48	15,53

IVR 754



Valvola "H" con attacco M per impianti monotubo/bitubo (con bypass regolabile 50-100%) con derivazioni a parete
 "H" valve with male connection for single/double pipe systems (with adjustable bypass 50-100%) with wall pipes
 Ein-/Zweirohr-Hahnblock (mit regelbarer Bypass 50-100%) Eckform mit AG Anschluß
 Pièce "H" avec embout mâle pour systèmes monotube/bitube (avec bypass réglable 50-100%) avec dérivation murales
 Клапан "H" с наружной резьбой для одно/двухтрубных систем (с регулируемым бай-пасом 50-100%) с возможностью монтажа в стену

Cod./Code	Misura/Size	□/田	€
175407001	3/4"	6/48	19,39

IVR 755



Valvola "H" con attacco M per impianti bitubo con derivazioni a pavimento
 "H" valve with male connection for double pipe systems with floor pipes
 Zweirohr-Hahnblock Durchgangsform mit AG Anschluß
 Pièce "H" avec embout mâle pour systèmes bitube avec dérivation au sol
 Клапан "H" с наружной резьбой, для двухтрубных систем, с возможностью монтажа в пол

Cod./Code	Misura/Size	□/田	€
175507001	3/4"	6/48	15,60

IVR 756



Valvola "H" con attacco "M" per impianti monotubo/bitubo (con bypass regolabile 50-100%) con derivazioni a pavimento

"H" valve with male connection for single/double pipe systems (with adjustable bypass 50-100%) with floor pipes

Ein-/Zweirohr-Hahnblock (mit regelbarer Bypass 50-100%) Durchgangsform mit AG Anschluß

Pièce "H" avec embout mâle pour systèmes monotube/bitube (avec bypass réglable 50-100%) avec dérivation au sol

Клапан "H" с наружной резьбой, для одно/двухтрубных систем (с регулируемым бай-пасом 50-100%), с возможностью монтажа в пол

Cod./Code	Misura/Size	□/田	€
175607001	3/4"	6/48	18,75

IVR 758



Adattatore per valvole "H"

Adapter for "H" valves

Adapter für "H"-Ventile

Adaptateur pour pièces "H"

Адаптер для "H" клапанов

Cod./Code	Misura/Size	□/田	€
175807051	3/4"x1/2"	100/800	1,62

VALVOLE FAN-COIL / FAN-COIL VALVES

IVR 748

NEW



Valvola fan-coil a 2 vie - attacchi M/M
Fan-coil 2-way valve - M/M
2-Wege Kugelhan für Gebläsekonvektoren - AG/AG
Vanne à 2 voies pour ventilo-convecteurs - M/M
2-ходовой клапан для фанкойлов ,соединения Н/Н

Cod./Code	Misura/Size	□/田	€
174805001	1/2"	1	11,59
174807001	3/4"	1	11,70
174810001	1"	1	16,73

IVR 749

NEW



Valvola fan-coil a 3 vie - attacchi M/M
Fan-coil 3-way valve - M/M
3-Wege Kugelhan für Gebläsekonvektoren - AG/AG
Vanne à 3 voies pour ventilo-convecteurs - M/M
3-ходовой клапан для фанкойлов ,соединения Н/Н

Cod./Code	Misura/Size	□/田	€
174905001	1/2"	1	14,96
174907001	3/4"	1	15,79
174910001	1"	1	21,11

IVR 750

NEW



Valvola fan-coil a 4 vie - attacchi M/M
Fan-coil 4-way valve - M/M
4-Wege Kugelhan für Gebläsekonvektoren - AG/AG
Vanne à 4 voies pour ventilo-convecteurs - M/M
4-ходовой клапан для фанкойлов ,соединения Н/Н

Cod./Code	Misura/Size	□/田	€
175005001	1/2"	1	18,71
175007001	3/4"	1	17,96
175010001	1"	1	27,23



COMPONENT / COMPONENTS

Adattatori / Adapters

IVR 580



Adattatori preassemblati per tubo rame - Nichelato
Adapters preassembled for copper pipe - Nickel plated
Eingebaute Zwischenstücke für Kupferrohr - Vernickelt
Adaptateurs préassemblés pour tubes en cuivre - Niklé
Адаптеры в сборе для медной трубы - Никелированные

Cod./Code	Misura/Size	Attacco/Connection	□/田	€
158005100	10	1/2"	20/200	3,00
158005120	12	1/2"	20/400	1,88
158005140	14	1/2"	20/200	2,21
158005150	15	1/2"	20/400	1,95
158005160	16	1/2"	20/400	2,21
158024100	10	24-19	20/400	2,74
158024120	12	24-19	20/400	2,10
158024140	14	24-19	20/400	2,60
158024150	15	24-19	20/400	2,14
158024160	16	24-19	20/400	2,14
158024180	18	24-19	20/400	2,21
158007120	12	3/4" EK	20/400	2,66
158007140	14	3/4" EK	20/400	2,63
158007150	15	3/4" EK	20/400	3,23
158007160	16	3/4" EK	20/400	2,25
158007180	18	3/4" EK	20/400	2,36

IVR 581



Adattatori universali a compressione per tubi multistrato e polietilene reticolato PEX, nichelati
Adapters for multilayer pipe and cross-linked polyethylene pipe PEX, nickel plated
Universal-Zwischenstücke/Adapter zur Kompressions für Mehrschichtrohre und Rohre aus vernetztem und vernickelt Polyethylen PEX - vernickelt
Adaptateurs universels à compression pour tubes multicouche et polyéthylène réticulé PEX - nichelés - nichelés
Никелированные универсальные компрессионные адаптеры для металлопластиковых труб ,труб из сшитого полиэтилена PEX, никелированных труб

Cod./Code	Misura/Size	Attacco/Connection	□/田	€
158105143	14 x 2	1/2"	20/400	2,06
158105156	15 x 2,5	1/2"	20/400	2,06
158105163	16 x 2	1/2"	20/400	2,21
158105164	16 x 2,25	1/2"	20/400	2,59
158124143	14 x 2	24-19	20/400	3,56
158124156	15 x 2,5	24-19	20/400	2,35
158124163	16 x 2	24-19	20/400	2,35
158124164	16 x 2,25	24-19	20/400	2,35
158124173	17 x 2	24-19	20/400	3,00
158124183	18 x 2	24-19	20/400	2,85
158124203	20 x 2	24-19	20/400	3,68
158107143	14 x 2	3/4" EK	20/400	2,35
158107163	16 x 2	3/4" EK	20/300	2,26
158107173	17 x 2	3/4" EK	20/300	4,01
158107183	18 x 2	3/4" EK	20/300	4,65
158107203	20 x 2	3/4" EK	20/300	3,60
158110203	20 x 2	1"	10/150	3,28
158110255	25 x 2,3	1"	10/150	4,14
158110256	25 x 2,5	1"	10/150	4,05
158110268	26 x 3	1"	10/80	4,05

COMPONENTI / COMPONENTS Centrale termica / Thermal central



IVR 334



Gruppo di alimentazione serie pesante per impianti di riscaldamento a circuito chiuso con riduttore di pressione, attacco manometro da 1/4", filtro e rubinetto di intercettazione. Entrata F, uscita M a bocchettone

Automatic filling unit with pressure reducer, 1/4" manometer connection, filter and shut off valve, with inlet F thread and M union connection

Versorgungsgruppe für Heizungssystemen mit geschlossenem Kreislauf mit Druckminderer - schwere Ausführung, Manometeranschluß 1/4", Filter und Absperrventil. Eingang IG und Ausgang AG mit Anschluss-Stutzen (Verschraubung)

Groupe d'alimentation série lourde pour implémentation de chauffage à circuit fermé avec reducteur de pression, fixations manomètre de 1/4", filtre et robinet d'interception. Entrée F sortie M à raccord

Группа подпитки, усиленная версия для закрытых систем отопления, включает редуктор давления, соединение под манометр 1/4", фильтр и перекрывающий клапан. Соединения: В со стороны входа и гон с накидной гайкой со стороны выхода

Cod./Code	Misura/Size	□/田	€
133405001	1/2"	1/15	33,54

IVR 336



Gruppo di alimentazione serie leggera per impianti di riscaldamento a circuito chiuso con riduttore di pressione, attacco manometro da 1/4", filtro e rubinetto di intercettazione. Entrata M a bocchettone, uscita F

Automatic filling unit with pressure reducer, 1/4" manometer connection, filter and shut off valve, with inlet M union connection and F thread

Versorgungsgruppe für Heizungssysteme mit geschlossenem Kreislauf mit Druckminderer - leichte Ausführung, Manometeranschluß 1/4", Filter und Absperrventil. Eingang (IG) und Ausgang (AG) mit Anschluss-Stutzen (Verschraubung)

Groupe d'alimentation série légère pour implémentation de chauffage à circuit fermé avec reducteur de pression, Fixations manomètre de 1/4", filtre et robinet d'interception. Entrée M raccord, sortie F

Группа подпитки, облегченная версия, для закрытых систем отопления, включает редуктор давления, соединение под манометр 1/4", фильтр и перекрывающий клапан. Соединения: патрубок с накидной гайкой со стороны входа и В со стороны выхода

Cod./Code	Misura/Size	□/田	€
133605001	1/2"	1/25	25,80

IVR 358



Manometro diametro 50 - 63 mm - attacco radiale Per IVR 334 - 336

Radial pressure gauge circle 50 - 63 mm. For IVR 334 - 336

Manometer Ø 50 - 63 mm - Anschluss unten, für IVR 304

Manometre Ø 50 - 63mm - fixation radiale pour ivr 304

Радиальный манометр 50-63 мм. Для IVR 334 - 336

Cod./Code	Misura/Size	□/田	€
135802116	1/4" Ø 50 - scala/scale 0-16 bar	1/100	7,28
135802206	1/4" Ø 63 - scala/scale 0-6 bar	1/100	8,25
135802210	1/4" Ø 63 - scala/scale 0-10 bar	1/100	8,25
135802216	1/4" Ø 63 - scala/scale 0-16 bar	1/100	8,25

COMPONENTI / COMPONENTS

Valvole di bilanciamento / Balancing valves



IVR 340



Valvola in ottone DZR ad orifizio fisso, filettata F/F (ISO 228/1 per DN15/20, ISO7/1 Rp oltre).
Brugola di presettaggio in dotazione. Condizioni di esercizio: da -10° C a +130° C

Fixed orifice DZR brass double reg. valve, threaded F/F (ISO 228/1 for DN15/20, ISO7/1 Rp above).
Valve supplied with allen key for setting. Working conditions: -10°C to +130° C

Ventil aus DZR-Messing mit fester Öffnung, alle Anschlüsse mit Innengewinde (ISO 228/1 für DN15/20, ISO7/1 Rp höher). Ausstattung mit Inbusschlüssel zur Voreinstellung. Betriebstemperatur von -10° C zu +130° C

Vanne d'équilibrage statique en laiton DZR, orifice fixe, fileté F/F (ISO 228/1 pour DN15 / 20, ISO7 / Rp 1 au-dessus). Valve fourni avec une clé Allen pour le réglage. Conditions de travail: -10° C à +130° C

Балансировочный клапан из латуни марки DZR, фиксированное отверстие, резьбовое соединение В/В (ISO 228/1 для DN15/20, ISO7/1). Клапан поставляется с ключом для регулировки. Рабочая температура от -10° C до +130° C

Cod./Code	Misura/Size	□/田	€
134005001	1/2"	4/16	58,10
134007001	3/4"	5/20	62,29
134010001	1"	4/16	65,22
134012001	1"1/4	4/16	99,50
134015001	1"1/2	2/8	120,75
134020001	2"	2/8	175,75

IVR 342



Valvola in ghisa a doppia reg. con prese di pressione in DZR (non montate), ad orifizio variabile, flangiata PN16 (EN1092-2). Condizioni di esercizio: da -10° C a +120° C

Cast iron double setting valve with test points in DZR brass (unmounted), variable orifice, Flangiata PN16 (EN1092-2). Working conditions: -10° C to +120° C

Ventil aus Gusseisen - DoppelEinstellung mit DZR Drucksteckdose (nicht eingebaut), mit veränderbarer Öffnung, Flansch PN16 (EN 1092-2). Betriebstemperatur: -10° C to +120° C

Vanne d'équilibrage statique en fonte, avec prises de pression pas montée, orifice variable, pourvue de brides PN16 (EN1092-2). Conditions de travail: -10° C à +120° C

Чугунный клапан с двойной регулировкой, вставки для контроля из латуни DZR (не установлены), фланцы PN16 (EN1092-2). Рабочая температура: от -10° C до +120° C

Cod./Code	Misura/Size	□/田	€
134225001	dn 65	1	429,00
134230001	dn 80	1	622,88
134240001	dn 100	1	853,88
134250001	dn 125	1	1175,63
134260001	dn 150	1	1460,25
134280001	dn 200	1	2582,25
134290001	dn 250	1	3778,50
134295001	dn 300	1	6971,25

IVR 341

NEW



Valvola in bronzo ad orifizio variabile, filettata F/F ISO 228/1, brugola di presettaggio in dotazione. Condizioni di esercizio da -10° a +130°

Bronze valve with variable orifice, F/F ISO 228/1 threaded unions, supplied with Allen key for setting. Working temperatures: -10 +130°

Ausgleichventil aus Rotguss mit veränderbarer Öffnung, IG/IG Gewinde ISO 228/1, geliefert mit dem Inbusschlüssel zur Voreinstellung. Betriebstemperaturen: -10° +130°

Vanne en bronze avec orifice variable, filetage F/F ISO 228/1, fournie avec la clé Allen pour le réglage. Températures de fonctionnement: -10° +130°

Бронзовый клапан с вариационным отверстием, резьбовое соединение В/В ISO 228/1, поставляется с установочным ключом. Условия эксплуатации от -10 ° до +130 °

Cod./Code	Misura/Size	□/田	€
134105001	1/2"	4/16	56,53
134107001	3/4"	5/20	59,88
134110001	1"	4/16	64,33
134112001	1"1/4	4/16	93,93
134115001	1"1/2	2/8	115,46
134120001	2"	2/8	153,74

IVR 344

NEW



Valvola di bilanciamento automatico in ottone DZR con bocchettoni filettata F/F ISO 7/1 RP condizioni di esercizio da -10° a +130°

Automatic balancing valve in DZR brass with tail piece F/F ISO 7/1 RP thread working temperatures -10° +130°

Automatisches Ausgleichsventil aus DZR-Messing mit Rohrverschraubungen Gewinde IG/IG ISO 7/1 RP Betriebstemperaturen -10° +130°

Vanne d'équilibrage en laiton DZR avec raccord de tuyauterie température de fonctionnement -10° +130°

Автоматический балансировочный клапан из латуни DZR, со сгоном ,резьбовые соединения В/В ISO 7/1 RP . Условия эксплуатации от -10 ° до + 130 °

Cod./Code	Misura/Size	□/田	€
134405001	1/2"	4/16	57,17
134407001	3/4"	5/20	62,94
134410001	1"	4/16	70,13
134412001	1*1/4	4/16	139,44
134415001	1*1/2	2/8	147,98
134420001	2"	2/8	172,70

IVR 344/C

NEW



Cartuccia stabilizzatrice di portata per valvola di bilanciamento automatico

Cartridge for the stabilisation of water flow for automatic balancing

Kartusche zur Stabilisierung des Wasserflusses für automatischen Ausgleich

Cartouche de stabilisation du débit pour la vanne d'équilibrage automatique

Картридж стабилизации потока для автоматического балансировочного клапана

DN15 - DN20 - DN25

Cod./Code	Range ΔP	I/h	□/田	€
134452001	17 - 240 kPa	468	1	54,26
134452002	17 - 240 kPa	540	1	54,26
134452003	17 - 240 kPa	612	1	54,26
134452004	17 - 240 kPa	684	1	54,26
134452011	18 - 240 kPa	756	1	54,26
134452012	18 - 240 kPa	864	1	54,26
134452013	18 - 240 kPa	972	1	54,26
134452014	18 - 240 kPa	1080	1	54,26
134452015	18 - 240 kPa	1188	1	54,26
134452016	18 - 240 kPa	1296	1	54,26
134452017	18 - 240 kPa	1440	1	54,26
134452021	19 - 240 kPa	1620	1	54,26
134452022	19 - 240 kPa	1800	1	54,26
134452031	21 - 240 kPa	1980	1	54,26
134452041	22 - 240 kPa	2160	1	54,26
134452051	24 - 240 kPa	2376	1	54,26
134452052	24 - 240 kPa	2592	1	54,26

DN32 - DN40 - DN50

Cod./Code	Range ΔP	I/h	□/田	€
134453001	13 - 230 kPa	1116	1	91,54
134453002	13 - 230 kPa	1224	1	91,54
134453003	13 - 230 kPa	1332	1	91,54
134453011	14 - 230 kPa	1440	1	91,54
134453012	14 - 230 kPa	1656	1	91,54
134453013	14 - 230 kPa	1800	1	91,54
134453014	14 - 230 kPa	1980	1	91,54
134453015	14 - 230 kPa	2088	1	91,54
134453016	14 - 230 kPa	2232	1	91,54
134453021	15 - 230 kPa	2412	1	91,54
134453022	15 - 230 kPa	2664	1	91,54
134453023	15 - 230 kPa	2988	1	91,54
134453024	15 - 230 kPa	3240	1	91,54
134453025	15 - 230 kPa	3492	1	91,54
134453026	15 - 230 kPa	3780	1	91,54
134453027	15 - 230 kPa	4320	1	91,54
134453031	16 - 230 kPa	4680	1	91,54
134453041	17 - 230 kPa	5184	1	91,54
134453042	17 - 230 kPa	5616	1	91,54
134453051	18 - 230 kPa	6048	1	91,54
134453061	19 - 230 kPa	6480	1	91,54
134453062	19 - 230 kPa	7056	1	91,54

IVR 346



Prese di pressione, filettata M 1/4" ISO 7/1 R in ottone DZR
 Pressure test point, M 1/4" ISO 7/1 R in DZR brass
 Drucksteckdose, Außengewinde 1/4" ISO 7/1 R aus DZR-Messing
 Prises de pression, filetée M 1/4" ISO 7/1 R en laiton DZR
 Точка контроля давления, соединения Н 1/4" ISO 7/1 R, латунь марки DZR

Cod./Code	Misura/Size	□/田	€
134610201	1/4" presa press cravatta blu	5/90	7,43
134610202	1/4" presa press cravatta ros	5/90	7,43
134630201	1/4" kit pr press c/prol crav blu	5/90	23,93
134630202	1/4" kit pr press c/prol crav ros	5/90	23,93

COMPONENTI / COMPONENTS

Gruppi valvole di Sicurezza e scarico caldaia / Safety Valves

IVR 718



Gruppo di sicurezza caldaia in ottone; valvola di intercettazione; manometro; scarico aria automatico; valvola di sicurezza

Brass safety set; automatic shut-off valve; pressure gauge; automatic air-vent; safety valve

Sicherheitsgruppe für Heizkessel aus Messing; Abfang / Absperrventil; Manometer; automatisches Entlüftung; Sicherheitsventil

Groupe de sécurité chaudière en laiton, vanne d'interception, manometre; sortie aire automatique; vanne de sécurité

Группа безопасности котла латунная, отсекающий кран, манометр, автоматический воздухоотводчик, предохранительный клапан

Cod./Code	Misura/Size	□/田	€
171810020	1" - 2,0 bar	1/7	52,57
171810025	1" - 2,5 bar	1/7	52,57
171810030	1" - 3,0 bar	1/7	52,57
171810040	1" - 4,0 bar	1/7	52,57
171810050	1" - 5,0 bar	1/7	52,57

IVR 718/C



Guscio di coibentazione per GRUPPO SAFETY IVR 718

Isolating element for SAFETY SET IVR 718

Isolierhülse für SAFETY SET IVR 718

Coque isolante pour GROUPE SAFETY IVR 718

Изолирующий элемент для ГРУППЫ БЕЗОПАСНОСТИ IVR 718

Cod./Code	Misura/Size	□/田	€
335800421	Guscio / Coibent	1/5	18,11

IVR 355



Valvola di sicurezza M/F
Safety valve M/F
Sicherheitsventile AG/IG
Soupape de sécurité M/F
Предохранительный клапан Н/В

Cod./Code	Misura/Size	□/田	€
135505151	1/2" 1.5 Bar	10/150	5,11
135505201	1/2" 2 Bar	10/150	5,11
135505251	1/2" 2.5 Bar	10/150	5,11
135505301	1/2" 3 Bar	10/150	5,11
135505401	1/2" 4 Bar	10/150	5,11
135505501	1/2" 5 Bar	10/150	5,11
135505601	1/2" 6 Bar	10/150	5,11

IVR 356



Valvola di sicurezza M/F - con attacco manometro 1/4"
Safety valve M/F - with manometer connection 1/4"
Sicherheitsventile AG/IG - mit manometeranschluss 1/4"
Soupape de sécurité M/F - avec fixations pour le manomètre 1/4"
Предохранительный клапан В/Н - с соединением для манометра 1/4"

Cod./Code	Misura/Size	□/田	€
135605151	1/2" 1.5 Bar	10/100	6,74
135605201	1/2" 2 Bar	10/100	6,74
135605251	1/2" 2.5 Bar	10/100	6,74
135605301	1/2" 3 Bar	10/100	6,74
135605401	1/2" 4 Bar	10/100	6,74
135605501	1/2" 5 Bar	10/100	6,74
135605601	1/2" 6 Bar	10/100	6,74

IVR 350



Valvola di sicurezza F/F
Safety valve F/F
Sicherheitsventile IG/IG
Soupape de sécurité F/F
Предохранительный клапан В/В

Cod./Code	Misura/Size	□/田	€
135005151	1/2" 1.5 Bar	10/150	5,11
135005201	1/2" 2 Bar	10/150	5,11
135005251	1/2" 2.5 Bar	10/150	5,11
135005301	1/2" 3 Bar	10/150	5,11
135005401	1/2" 4 Bar	10/150	5,11
135005501	1/2" 5 Bar	10/150	5,11
135005601	1/2" 6 Bar	10/150	5,11
135007151	3/4" 1.5 Bar	10/140	8,02
135007201	3/4" 2 Bar	10/140	8,02
135007251	3/4" 2.5 Bar	10/140	8,02
135007301	3/4" 3 Bar	10/140	8,02
135007401	3/4" 4 Bar	10/140	8,02
135007501	3/4" 5 Bar	10/140	8,02
135007601	3/4" 6 Bar	10/140	8,02
135010151	1" 1.5 Bar	10/60	11,91
135010201	1" 2 Bar	10/60	11,91
135010251	1" 2.5 Bar	10/60	11,91
135010301	1" 3 Bar	10/60	11,91
135010401	1" 4 Bar	10/60	11,91
135010501	1" 5 Bar	10/60	11,91
135010601	1" 6 Bar	10/60	11,91

IVR 351

NEW



Valvola di sicurezza F/F - con attacco manometro 1/4"

Safety valve F/F with manometer connection

Sicherheitsventil IG/IG mit Druckmesseranschluss

Soupape de sécurité F/F avec fixation manomètre

Предохранительный клапан В/В - с соединением для манометра 1/4"

Cod./Code	Misura/Size	□/田	€
135105151	1/2" 1.5 Bar	10/150	6,74
135105201	1/2" 2 Bar	10/150	6,74
135105251	1/2" 2.5 Bar	10/150	6,74
135105301	1/2" 3 Bar	10/150	6,74
135105401	1/2" 4 Bar	10/150	6,74
135105501	1/2" 5 Bar	10/150	6,74
135105601	1/2" 6 Bar	10/150	6,74

IVR 347

NEW



Valvola di sicurezza doppia funzione - temperatura e pressione attacchi filettati MF

Double-use safety valve - temperature and pressure M/F

Sicherheitsventil mit doppeltem Einsatz - Temperatur und Druck, AG/IG

Soupape de sécurité avec double fonction - température et pression, M/F

Двухфункциональный предохранительный клапан (температура и давление), резьбовые соединения Н/В

Cod./Code	Misura/Size	T°	PN	□/田	€
134705053	1/2" x 1/2"	90 °C	3 bar	1/24	34,35
134705054	1/2" x 1/2"	90 °C	4 bar	1/24	34,35
134705056	1/2" x 1/2"	90 °C	6 bar	1/24	34,35
134705057	1/2" x 1/2"	90 °C	7 bar	1/24	34,35
134705058	1/2" x 1/2"	90 °C	8 bar	1/24	34,35
134707053	3/4" x 1/2"	90 °C	3 bar	1/24	34,13
134707054	3/4" x 1/2"	90 °C	4 bar	1/24	34,13
134707056	3/4" x 1/2"	90 °C	6 bar	1/24	34,13
134707057	3/4" x 1/2"	90 °C	7 bar	1/24	34,13
134707058	3/4" x 1/2"	90 °C	8 bar	1/24	34,13
134707073	3/4" x 3/4"	90 °C	3 bar	1/24	37,46
134707074	3/4" x 3/4"	90 °C	4 bar	1/24	37,46
134707076	3/4" x 3/4"	90 °C	6 bar	1/24	37,46
134707077	3/4" x 3/4"	90 °C	7 bar	1/24	37,46
134707078	3/4" x 3/4"	90 °C	8 bar	1/24	37,46

IVR 354

NEW



Valvola di sicurezza doppia funzione - temperatura e pressione attacchi M e raccordo a bicono per tubo rame

Double-use safety valve - temperature and pressure M and copper compression connection

Sicherheitsventil mit doppeltem Einsatz - Temperatur und Druck, AG und Kupfer-Kompressionsverbindung

Soupape de sécurité avec double fonction - température et pression, M et raccord à compression pour tube en cuivre

Двухфункциональный предохранительный клапан - (температура и давление), Наружный фитинг с двойным конусом для медной трубы

Cod./Code	Misura/Size	T°	PN	□/田	€
135405153	1/2" x 15	90 °C	3 bar	1/24	35,44
135405154	1/2" x 15	90 °C	4 bar	1/24	35,44
135405156	1/2" x 15	90 °C	6 bar	1/24	35,44
135405157	1/2" x 15	90 °C	7 bar	1/24	35,44
135405158	1/2" x 15	90 °C	8 bar	1/24	35,44
135407153	3/4" x 15	90 °C	3 bar	1/24	37,20
135407154	3/4" x 15	90 °C	4 bar	1/24	37,20
135407156	3/4" x 15	90 °C	6 bar	1/24	37,20
135407157	3/4" x 15	90 °C	7 bar	1/24	37,20
135407158	3/4" x 15	90 °C	8 bar	1/24	37,20
135407223	3/4" x 22	90 °C	3 bar	1/24	41,36
135407224	3/4" x 22	90 °C	4 bar	1/24	41,36
135407226	3/4" x 22	90 °C	6 bar	1/24	41,36
135407227	3/4" x 22	90 °C	7 bar	1/24	41,36
135407228	3/4" x 22	90 °C	8 bar	1/24	41,36



IVR 369



Valvola di sicurezza a squadra a tenuta metallica
Angle safety valve with metallic sealing
Eckförmiges Sicherheitsventil mit Metalldichtung
Soupape de sécurité équerre avec obturateur métallique
Угловой предохранительный клапан с металлическим уплотнением

Cod./Code	Misura/Size	□/田	€
136905001	1/2"	50	23,44
136907001	3/4"	40	32,81
136910001	1"	25	44,25
136912001	1" 1/4	15	67,31
136915001	1" 1/2	10	86,25
136920001	2"	5	115,13

IVR 352



Valvola di sicurezza per scaldabagni - tipo leggero
Safety valve for water heaters - light version
Sicherheitsventil für Wasserkessel - leichte Ausführung
Soupape de sécurité pour chauffe eau - variante légère
Предохранительный клапан для водонагревателей - облегченная версия

Cod./Code	Misura/Size	□/田	€
135205001	1/2"	25/300	4,65



IVR 352/L



Valvola di sicurezza con leva per scaldabagni - tipo leggero
Safety valve for water heaters - light version
Sicherheitsventil für Wasserkessel - leichte Ausführung
Soupape de sécurité pour chauffe eau - variante lourde
Предохранительный клапан с ручкой "флажок" для водонагревателей - облегченная версия

Cod./Code	Misura/Size	□/田	€
135205002	1/2"	250	4,65



IVR 353



Valvola di sicurezza per scaldabagni - tipo pesante
Safety valve for water heaters - heavy version
Sicherheitsventil für Wasserkessel - schwere Ausführung
Soupape de sécurité pour chauffe eau - variante lourde
Предохранительный клапан для водонагревателей - усиленная версия

Cod./Code	Misura/Size	□/田	€
135305001	1/2"	200	6,60



IVR 353/L

NEW



Valvola di sicurezza con leva per scaldabagni - tipo pesante
Safety valve for water heaters - heavy version
Sicherheitsventil für Wasserkessel - schwere Ausführung
Soupape de sécurité pour chauffe eau - variante lourde
Предохранительный клапан с ручкой "флажок" для водонагревателей - усиленная версия

Cod./Code	Misura/Size	□/田	€
135305002	1/2"	150	7,50

IVR 103



Rubinetto per scarico caldaia serie pesante con quadro di manovra e cappuccio con chiave incorporata; attacco F
Heavy boiler blow-off valve. Fastenings F - hose connect
KFE-Hahn - schwere Ausführung - mit Schalltabelle und Kappe mit integriertem Schlüssel - Anschluss IG
Robinet d'évacuation chaudière série lourde avec tableau de manoeuvre et capuchon à clé intégrée - fixation F
Усиленный сливной клапан для котла тяжелой серии с квадратной управляющей головкой и крышкой со встроенным ключом. Соединение B

Cod./Code	Misura/Size	Ø	□/田	€
110305001	1/2"x3/4"	10	10/60	10,52
110307001	3/4"x1"	15	10/60	16,12
110310001	1"	25	10/40	24,46

IVR 105



Rubinetto per scarico caldaia serie pesante con quadro di manovra e cappuccio con chiave incorporata attacco M
Heavy boiler blow-off valve. Fastenings M - hose connect
KFE-Hahn - schwere Ausführung - mit Schalltabelle und Kappe mit integriertem Schlüssel - Anschluss AG
Robinet d'évacuation chaudière série lourde avec tableau de manoeuvre et capuchon à clé intégrée - fixation M
Усиленный сливной клапан для котла тяжелой серии с квадратной управляющей головкой и крышкой со встроенным ключом. Соединение H

Cod./Code	Misura/Size	Ø	□/田	€
110505001	1/2"x3/4"	10	10/60	10,89
110507001	3/4"x1"	15	10/60	16,47
110510001	1"	25	10/40	25,40

IVR 904



Rubinetto per scarico caldaia completo di tappo; attacchi M - portagomma - leva nera
Boiler blow-off valve complete with hose tail and plug - Fastenings M - hose connect - black handle
KFE-Hahn mit Deckel - Anschlüsse AG - Schlauchanschluss - schwarzer Griff
Robinet d'évacuation chaudière avec bouchon - fixations M - porte tuyau souple - Poignée noire
Сливной кран для котла в комплекте с заглушкой и соединением под шланг. Соединение H - черная ручка-флажок

Cod./Code	Misura/Size	Ø	□/田	€
190403001	3/8"x3/4"	8	40/160	4,78
190405001	1/2"x3/4"	10	40/160	5,12
190407001	3/4"x1"	15	20/100	7,74

IVR 905



Rubinetto per scarico caldaia completo di tappo; attacchi M - portagomma - leva rossa e guarnizione di tenuta

Boiler blow-off valve complete with hose tail and plug - Fastenings M - hose connect - red handle and seal

KFE-Hahn mit Deckel - Anschlüsse AG - Schlauchanschluss - roter Griff und Dichtung

Robinet d'évacuation chaudière avec bouchon - fixations M - porte tuyau souple - poignée rouge et joint étanchéité

Сливной кран для котла в комплекте с заглушкой и соединением под шланг. Соединение Н - красная ручка-флажок и прокладка

Cod./Code	Misura/Size	Ø	□/⊞	€
190505001	1/2"x3/4"	10	20/100	6,49

IVR 62



Rubinetto per scarico caldaia serie pesante, con tappo, attacco F

Heavy boiler blow-off valve. F threads with plug

KFE-Hahn schwere Ausführung mit Kappe Anschluss IG

Robinet d'évacuation chaudière type lourd fixation F et bouchon

Сливной кран для котла тяжелой серии, с заглушкой, соединение B

Cod./Code	Misura/Size	□/⊞	€
106205001	1/2" scarico caldaia Fem Nic	10/60	6,37
106205011	1/2" scarico caldaia Fem Gia	10/60	6,22

IVR 64



Rubinetto per scarico caldaia serie pesante, con tappo, attacco M

Heavy boiler drain valve with cap and M connection

KFE-Hahn mit Kappe - Anschluss AG

Robinet d'évacuation chaudière type lourd avec bouchon - fixation M

Сливной кран для котла тяжелой серии, с заглушкой, соединение H

Cod./Code	Misura/Size	□/⊞	€
106405001	1/2" scarico caldaia Mas Nic	10/60	6,83
106405011	1/2" scarico caldaia Mas Gia	10/60	6,67

IVR 149

NEW



Rubinetto porta manometro M/F con premistoppa e foro di spurgo, maniglia termoplastica
 Manometer holder M/F with packing nut and drain hole, handle in thermoplastic
 Manometerhalter AG/IG mit Stopfbüchse und Ablassbohrung und Griff aus Thermoplastik
 Robinet porte-manomètre M/F avec presse-étoupe et purge, poignée en thermoplastique
 Кран для установки манометра, соединения Н/В, с сальником, выпускным отверстием, термопластиковая ручка

Cod./Code	Misura/Size	□/田	€
114902001	1/4"	10/60	12,34
114903001	3/8"	10/60	12,71
114905001	1/2"	10/60	13,91

IVR 150

NEW



Rubinetto porta manometro M/F con premistoppa, flangia e tappo su flangia e foro di spurgo, maniglia termoplastica
 Manometer holder M/F with packing nut, flange and cap on the flange, handle in thermoplastic
 Manometerhalter AG/IG mit Stopfbüchse, Flansche und Deckel auf der Flansche, Griff aus Thermoplastik
 Robinet porte-manomètre M/F avec presse-étoupe, bride et bouchon sur la bride, poignée en thermoplastique
 Кран для установки манометра, соединения Н/В, с сальником, выпускным отверстием, фланцем и заглушкой на фланце, термопластиковая ручка

Cod./Code	Misura/Size	□/田	€
115002001	1/4"	10/60	15,11
115003001	3/8"	10/60	15,90
115005001	1/2"	10/60	17,48

IVR 909

NEW



Defangatore magnetico completo di tappo, bocchettoni e rubinetto di scarico
 Dirt separator with magnet, cap, fittings and drain cock with hose connection
 Séparateur de boue magnétique avec bouchon, raccords et robinet de vidange avec tétine
 Schlammabscheider mit magnet, kappe, anschluss-stuck und entleerungshahn mit schlauch-anschluss
 Магнитный грязеуловитель (дешламатор) с заглушкой, фитингами и сливным краном с насадкой для шланга

Cod./Code	Misura/Size	□/田	€
190907000	3/4"	1/6	88,00

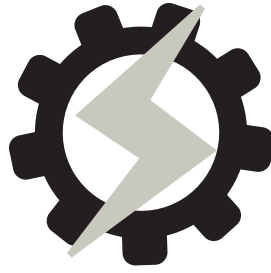

SERVOCOMANDI E VALVOLE MOTORIZZABILI
ACTUATORS AND MOTORIZED VALVES
SERVOSTEUERUNGEN UND MOTORISIERBARE KUGELHÄHNE
SERVOCOMMANDES ET VANNES MOTORISABLES
ЭЛЕКТРИЧЕСКИЕ И ПНЕВМАТИЧЕСКИЕ ПРИВОДЫ





Compact Motor + Motorhead

Valvole di zona 2 vie - 2 way zone valves	p. 114
Valvole di zona 3 vie deviatrici - 3 way diverter zone valves	p. 115
Valvole di zona 3 vie by-pass - 3 way by-pass zone valves	p. 117



Compact Motor

Valvole di zona 2 vie - 2 way zone valves	p. 118
Valvole di zona 3 vie deviatrici - 3 way diverter zone valves	p. 120
Valvole di zona 3 vie by-pass - 3 way by-pass zone valves	p. 121



Motorhead

Servocomandi per valvole - Actuators for valves	p. 123
---	--------



Automat + Motorhead

Automat MIX + Motorhead MIX	p. 126
Automat DIV + Motorhead DIV	p. 129
Automat MIX Easy + Motorhead MIX easy	p. 131
Automat DIV Easy + Motorhead DIV easy	p. 132
Componenti di controllo - Components for control	p. 133



COMPACT MOTOR + MOTORHEAD



AUTOMAT L + MOTORHEAD ISO



COMPACT MOTOR



AUTOMAT L



MOTORHEAD



MOTORHEAD ISO

2 VIE/WAY

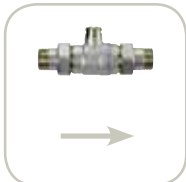

F/F IVR 220
 M/F IVR 221
 M/M IVR 222
 C/C IVR 223

3 VIE/WAY D



F/F/M IVR 235
 M/F/M IVR 236
 M/M/M IVR 237
 C/C/M IVR 238

3 VIE/WAY BP

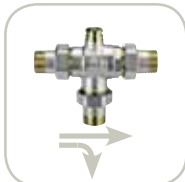

F/F/M IVR 240
 M/F/M IVR 241
 M/M/M IVR 242
 C/C/M IVR 243

2 VIE/WAY



F/F IVR 230

UNI-BI DIREZIONALE/ONE-BI DIRECTIONAL



IVR 215

- Relè (2 Pt./Cnt.)
 - NO Relè (3 Pt./Cnt.)

Con/With 1 AUX Microswitch



IVR 215

- Relè (2 Pt./Cnt.)
 - NO Relè (3 Pt./Cnt.)

Con/With 1 AUX Microswitch

BI DIREZIONALE/BI DIRECTIONAL



IVR 217

- NO Relè (3 Pt./Cnt.)

Con/With 1 AUX Microswitch

COMPACT MOTOR + MOTORHEAD

Valvole di zona 2 vie - 2 ways zone valves

IVR 220 + IVR 215



IVR 220 Compact Motor, valvola di zona a 2 vie, attacchi F/F + IVR 215 Motorhead uni-bidirezionale 230 V. con relé a 2 punti, 1 micro supplementare

IVR 220 Compact Motor, 2-way zone valve, threaded ends F/F + IVR 215 uni-/bidirectional Motorhead 230 V with relay, 2 contact terminals, 1 auxiliary microswitch

IVR 220 Compact Motor, 2-Wege-Zonenventil, IG/IG + IVR 215 Motorhead, uni-bidirektional 230 V, mit Relais, mit 2-Punkt-Steuerung und einem zusätzlichen Mikroschalter

IVR 220 Compact Motor, vanne de zone à 2 voies, fixations F/F + IVR 215 Motorhead uni-bidirectionnel 230 V avec relais, 2 points, 1 micro supplémentaire

IVR 220 Compact Motor, двухходовой клапан, соединения В/В + IVR 215 Motorhead одно-двухнаправленный 230 V, 2 контактных зажима с реле, 1 вспомогательный микровыключатель

Cod./Code	Misura/Size	□/田	€
422005106	1/2"	1/4	95,73
422007106	3/4"	1/4	99,25
422010106	1"	1/4	105,99
422012106	1*1/4	1/4	110,58



IVR 230 + IVR 217



IVR 230 Automat L, valvola di zona a 2 vie, flangia ISO 5211, attacchi F/F + IVR 217 Motorhead, bidirezionale 230 V. 3 punti

IVR 230 Automat L, 2-way zone valve, ISO 5211 flange, threaded ends F/F + IVR 217 Motorhead, bidirectional 230 V, 3 contact terminals

IVR 230 Automat L, 2-Wege-Zonenventil, mit Flansch ISO 5211, IG/IG + IVR 217 Motorhead, bidirektional 230 V 3-Punkt-Steuerung

IVR 230 Automat L, vanne de zone à 2 voies, avec la bride ISO 5211, fixations F/F + IVR 217 Motorhead, bidirectionnelle 230V, 3 points

IVR 230 Automat L, двухходовой клапан, фланец ISO 5211, соединения В/В + IVR 217 Motorhead, двунаправленный 230 V, 3 контактных зажима

Cod./Code	Misure/Size	ISO 5211	□/田	€
423015218	1*1/2	FO4	1/4	203,88
423020218	2"	FO4	1/4	218,94



IVR 221 + IVR 215



IVR 221 Compact Motor, valvola di zona a 2 vie, attacchi M/F + IVR 215 Motorhead uni-bidirezionale 230 V. con relé a 2 punti, 1 micro supplementare

IVR 221 Compact Motor, 2-way zone valve, threaded ends M/F + IVR 215 uni-/bidirectional Motorhead 230 V with relay, 2 contact terminals, 1 auxiliary microswitch

IVR 221 Compact Motor 220, 2-Wege-Zonenventil, AG/IG + IVR 215 Motorhead, uni-bidirektional 230 V, mit Relais, mit 2-Punkt-Steuerung und einem zusätzlichen Mikroschalter

IVR 221 Compact Motor, vanne de zone à 2 voies, fixations M/F + IVR 215 Motorhead uni-bidirectionnel 230 V avec relais, 2 points, 1 micro supplémentaire

IVR 221 Compact Motor, двухходовой клапан, соединения Н/В + IVR 215 Motorhead одно-двухнаправленный 230 V, 2 контактных зажима с реле, 1 вспомогательный микровыключатель

Cod./Code	Misura/Size	□/田	€
422105106	1/2"	1/4	98,18
422107106	3/4"	1/4	102,42
422110106	1"	1/4	110,53
422112106	1*1/4	1/4	117,29



IVR 222 + IVR 215



IVR 222 Compact Motor, valvola di zona a 2 vie, attacchi M/M + IVR 215 Motorhead uni-bidirezionale 230 V. con relé a 2 punti, 1 micro supplementare

IVR 222 Compact Motor, 2-way zone valve, threaded ends M/M + IVR 215 uni-/bidirectional Motorhead 230 V with relay, 2 contact terminals, 1 auxiliary microswitch

IVR 222 Compact Motor, 2-Wege-Zonenventil, AG/AG + IVR 215 Motorhead, uni-bidirektional 230 V, mit Relais, mit 2-Punkt-Steuerung und einem zusätzlichen Mikroschalter

IVR 222 Compact Motor, vanne de zone à 2 voies, fixations M/M + IVR 215 Motorhead uni-bidirectionnel 230 V avec relais, 2 points, 1 micro supplémentaire

IVR 222 Compact Motor, двухходовой клапан, соединения H/H + IVR 215 Motorhead одно-двунаправленный 230 V, 2 контактных зажима с реле, 1 вспомогательный микровыключатель



Cod./Code	Misura/Size	□/田	€
422205106	1/2"	1/4	100,66
422207106	3/4"	1/4	105,81
422210106	1"	1/4	115,74
422212106	1"1/4	1/4	125,06

IVR 223 + IVR 215



SU RICHIESTA
 ON DEMAND

IVR 223 Compact Motor, valvola di zona a 2 vie, attacchi tubo rame a compressione C/C + Motorhead 215 uni-bidirezionale 230 V. con relé a 2 punti, 1 micro supplementare

IVR 223 Compact Motor, 2-way zone valve, copper compression ends for copper pipe CxC + IVR 215 uni-/bidirectional Motorhead 230 V with relay, 2 contact terminals, 1 auxiliary microswitch

IVR 223 Compact Motor, 2-Wege-Zonenventil, Kompressionanschlüsse für Kupferrohr + IVR 215 Motorhead, uni-bidirektional 230 V, mit Relais, mit 2-Punkt-Steuerung und einem zusätzlichen Mikroschalter

IVR 223 Compact Motor, vanne de zone à 2 voies, fixations tube cuivre à compression + IVR 215 Motorhead uni-bidirectionnel 230 V avec relais, 2 points, 1 micro supplémentaire

IVR 223 Compact Motor, двухходовой клапан, компрессионные соединения для медной трубы + 215 Motorhead одно-двунаправленный 230 V, 2 контактных зажима с реле, 1 вспомогательный микровыключатель



LOTTO MINIMO
 MINIMUM BATCH

Cod./Code	Misura/Size	LM/MB	□/田	€
422315106	15		1/4	97,23
422322106	22		1/4	101,57
422328106	28		1/4	108,51

COMPACT MOTOR + MOTORHEAD

Valvole di zona 3 vie deviatrici - 3 ways diverter zone valves

IVR 235 + IVR 215



IVR 235 Compact Motor, valvola di zona a 3 vie deviatrici, attacchi F/F/M + IVR 215 Motorhead uni-bidirezionale 230 V. con relé a 2 punti, 1 micro supplementare

IVR 235 Compact Motor 3-way diverting zone valve, threaded ends F/F/M + IVR 215 uni-/bidirectional Motorhead 230 V with relay, 2 contact terminals, 1 auxiliary microswitch

IVR 235 Compact Motor, 3-Wege-Ableitzoneventil, IG/IG/AG + IVR 215 Motorhead, uni-bidirektional 230 V, mit Relais, mit 2-Punkt-Steuerung und einem zusätzlichen Mikroschalter

IVR 235 Compact Motor, vanne de zone déviatrice à 3 voies, fixations F/F/M + IVR 215 Motorhead uni-bidirectionnel 230 V avec relais, 2 points, 1 micro supplémentaire

IVR 235 Compact Motor, трехходовой клапан распределитель, соединения В/В/Н + IVR 215 Motorhead одно-двунаправленный 230 V, 2 контактных зажима с реле, 1 вспомогательный микровыключатель



Cod./Code	Misura/Size	□/田	€
423507112	3/4"	1/4	108,71
423510112	1"	1/4	118,47

IVR 236 + IVR 215



IVR 236 Compact Motor, valvola di zona a 3 vie deviatrice, attacchi M/F/M + IVR 215 Motorhead uni-bidirezionale 230 V. con relé a 2 punti, 1 micro supplementare

IVR 236 Compact Motor, 3-way diverting zone valve, threaded ends M/F/M + IVR 215 Motorhead uni-bidirectional 230 V with relay, 2 contact terminals, 1 microswitch

IVR 236 Compact Motor, 3-Wege-Ableitzoneventil, AG/IG/AG + IVR 215 Motorhead, uni-bidirektional 230 V, mit Relais, mit 2-Punkt-Steuerung und einem zusätzlichen Mikroschalter

IVR 236 Compact Motor, vanne de zone déviatrice à 3 voies, fixations M/F/M + IVR 215 Motorhead uni-bidirectionnel 230 V avec relais, 2 points, 1 micro supplémentaire

IVR 236 Compact Motor ,трехходовой клапан распределитель ,соединения Н/В/Н + IVR 215 Motorhead одно - двунаправленный 230 V, 2 контактных зажима с реле, 1 вспомогательный микровыключатель

Cod./Code	Misura/Size	□/田	€
423607112	3/4"	1/4	111,82
423610112	1"	1/4	123,20

IVR 237 + IVR 215



IVR 237 Compact Motor, valvola di zona a 3 vie deviatrice, attacchi M/M/M + IVR 215 Motorhead uni-bidirezionale 230 V. con relé a 2 punti, 1 micro supplementare

IVR 237 Compact Motor, 3-way diverting zone valve, threaded ends M/M/M + IVR 215 Motorhead uni-bidirectional 230 V with relay, 2 contact terminals, 1 microswitch

IVR 237 Compact Motor, 3-Wege-Ableitzoneventil, AG/AG/AG + IVR 215 Motorhead, uni-bidirektional 230 V, mit Relais, mit 2-Punkt-Steuerung und einem zusätzlichen Mikroschalter

IVR 237 Compact Motor, vanne de zone déviatrice à 3 voies, fixations M/M/M + IVR 215 Motorhead uni-bidirectionnel 230 V avec relais, 2 points, 1 micro supplémentaire

IVR 237 Compact Motor ,трехходовой клапан распределитель ,соединения Н/Н/Н + IVR 215 Motorhead одно-двунаправленный 230 V , 2 контактных зажима с реле, 1 вспомогательный микровыключатель

Cod./Code	Misura/Size	□/田	€
423707112	3/4"	1/4	115,14
423710112	1"	1/4	128,45

IVR 238 + IVR 215



IVR 238 Compact Motor, valvola di zona a 3 vie deviatrice, attacchi rame a compressione C/C/M + IVR 215 Motorhead uni-bidirezionale 230 V. con relé a 2 punti, 1 micro supplementare

IVR 238 Compact Motor, diverting 3-way zone valve, copper compression ends + IVR 215 Motorhead uni-bidirectional 230 V with relay, 2 contact terminals, 1 auxiliary microswitch

IVR 238 Compact Motor, 3-Wege-Ableitzoneventil, Kompressionanschlüsse für Kupferrohr + IVR 215 Motorhead, uni-bidirektional 230 V, mit Relais, mit 2-Punkt-Steuerung und einem zusätzlichen Mikroschalter

IVR 238 Compact Motor, vanne de zone déviatrice à 3 voies, fixations tube cuivre + IVR 215 Motorhead uni-bidirectionnel 230 V avec relais, 2 points, 1 micro supplémentaire

IVR 238 Compact Motor ,трехходовой клапан распределитель,компрессионные соединения для медной трубы - Н + IVR 215 Motorhead одно-двунаправленный 230 V, 2 контактных зажима с реле, 1 вспомогательный микровыключатель

Cod./Code	Misure/Size	LM/MB	□/田	€
423822112	22 x 22 x 1"		1/4	110,76
423828112	28 x 28 x 1"		1/4	120,72

COMPACT MOTOR + MOTORHEAD

Valvole di zona 3 vie by-pass - 3 ways by-pass zone valves

IVR 240 + IVR 215



IVR 240 Compact Motor, valvola a sfera a passaggio totale, con by-pass, motorizzabile, attacchi F/F/M + IVR 215 Motorhead uni-bidirezionale 230 V. con relé a 2 punti, 1 micro supplementare

IVR 240 Compact Motor, full bore ball valve, with by-pass, motorisable, threaded ends F/F/M + IVR 215 Motorhead uni-/bidirectional 230 V with relay, 2 contact terminals, 1 auxiliary microswitch

IVR 240 Compact Motor, motorisierbares Kugelventil mit vollem Durchgang, mit Bypass, IG/IG/AG + IVR 215 Motorhead, uni-bidirektional 230 V, mit Relais, mit 2-Punkt-Steuerung und einem zusätzlichen Mikroschalter

IVR 240 Compact Motor, vanne à boisseau sphérique à passage intégral, avec by-pass, motorisable, fixations F/F/M + IVR 215 Motorhead uni-bidirectionnel 230 V avec relais, 2 points, 1 micro supplémentaire

IVR 240 Compact Motor, полнопроходной шаровой кран для привода, с бай-пасс, соединения В/В/Н + IVR 215 Motorhead одно-двунаправленный 230 V, 2 контактных зажима с реле, 1 вспомогательный микровыключатель



Cod./Code	Misura/Size	□/田	€
424007112	3/4"	1/4	111,82
424010112	1"	1/4	125,65

IVR 241 + IVR 215



IVR 241 Compact Motor, valvola a sfera a passaggio totale, con by-pass, motorizzabile, attacchi M/F/M + IVR 215 Motorhead uni-bidirezionale 230 V. con relé a 2 punti, 1 micro supplementare

IVR 241 Compact Motor, full bore ball valve with by-pass, motorisable, threaded ends M/F/M + IVR 215 uni-/bidirectional 230 V with relay, 2 contact terminals, 1 auxiliary microswitch

IVR 241 Compact Motor, motorisierbares Kugelventil mit vollem Durchgang, mit Bypass, AG/IG/AG + IVR 215 Motorhead, uni-bidirektional 230 V, mit Relais, mit 2-Punkt-Steuerung und einem zusätzlichen Mikroschalter

IVR 241 Compact Motor, vanne à boisseau sphérique à passage intégral, avec by-pass, motorisable, fixations M/F/M + IVR 215 Motorhead uni-bidirectionnel 230 V avec relais, 2 points, 1 micro supplémentaire

IVR 241 Compact Motor, полнопроходной шаровой кран для привода, с бай-пасс, соединения Н/В/Н + IVR 215 Motorhead одно-двунаправленный 230 V, 2 контактных зажима с реле, 1 вспомогательный микровыключатель



Cod./Code	Misura/Size	□/田	€
424107112	3/4"	1/4	108,43
424110112	1"	1/4	120,38

IVR 242 + IVR 215



IVR 242 Compact Motor, valvola a sfera a passaggio totale, con by-pass, motorizzabile, attacchi M/M/M + IVR 215 Motorhead uni-bidirezionale 230 V. con relé a 2 punti, 1 micro supplementare

IVR 242 Compact Motor, full bore ball valve with by-pass, motorisable, threaded ends M/M/M + IVR 215 uni-/bidirectional 230 V with relay, 2 contact terminals, 1 auxiliary microswitch

IVR 242 Compact Motor, motorisierbares Kugelhahn mit vollem Durchgang, mit Bypass, AG/AG/AG + IVR 215 Motorhead, uni-bidirektional 230 V, mit Relais, mit 2-Punkt-Steuerung und einem zusätzlichen Mikroschalter

IVR 242 Compact Motor, vanne à boisseau sphérique à passage intégral, avec by-pass, motorisable, fixations M/M/M + IVR 215 Motorhead uni-bidirectionnel 230 V avec relais, 2 points, 1 micro supplémentaire

IVR 242 Compact Motor, полнопроходной шаровой кран для привода, с бай-пасс, соединения Н/Н/Н + IVR 215 Motorhead одно-двунаправленный 230 V, 2 контактных зажима с реле, 1 вспомогательный микровыключатель



Cod./Code	Misura/Size	□/田	€
424207112	3/4"	1/4	111,79
424210112	1"	1/4	125,53

IVR 243 + IVR 215



IVR 243 Compact Motor, valvola a sfera a passaggio totale, con by-pass, motorizzabile, attacchi tubo rame a compressione C/C/M + IVR 215 Motorhead uni-bidirezionale 230 V. con relé a 2 punti, 1 micro supplementare

IVR 243 Compact Motor, full bore ball valve with by-pass, motorisable, with compression ends for copper pipe + IVR 215 uni-/bidirectional MOTORHEAD 230 V with relay, 2 contact terminals, 1 auxiliary microswitch

IVR 243 Compact Motor, motorisierbares Kugelhahn mit vollem Durchgang, mit Bypass, Kompressionanschlüsse für Kupferrohr + IVR 215 Motorhead, uni-bidirektional 230 V, mit Relais, mit 2-Punkt-Steuerung und einem zusätzlichen Mikroschalter

IVR 243 Compact Motor, vanne à boisseau sphérique à passage intégral, avec by-pass, motorisable, fixations tube cuivre à compression + IVR 215 Motorhead uni-bidirectionnel 230 V avec relais, 2 points, 1 micro supplémentaire

IVR 243 Compact Motor, полнопроходной шаровой кран для привода, с бай-пасс, с компрессионным соединением для медной трубы - Н + IVR 215 Motorhead одно-двухнаправленный 230 V, 2 контактных зажима с реле, 1 вспомогательный микровыключатель

Cod./Code	Misura/Size	LM/MB	□/田	€
424322112	22 x 22 x 1"		1/4	107,37
424328112	28 x 28 x 1"		1/4	117,91

COMPACT MOTOR

Valvole di zona 2 vie - 2 ways zone valves

IVR 220



Valvola a sfera a passaggio totale motorizzabile, 2 vie, attacchi F/F

2-way full bore ball valve, motorisable, F/F

2-Wege-Kugelhahn, motorisierbar, mit vollem Durchgang, IG/IG

Vanne à boisseau sphérique à passage intégral à 2 voies, motorisable, fixations F/F

Полнопроходной шаровой кран для привода, с двухходовым клапаном, соединения В/В



Cod./Code	DN	Ø	□/田	€
122005010	1/2	15	1/18	12,10
122007010	3/4"	20	1/18	15,62
122010010	1"	25	1/18	22,36
122012010	1"1/4	32	1/18	26,95

IVR 230



Valvola a sfera a passaggio totale, 2 vie, motorizzabile, con flangia ISO 5211, attacchi F/F

2-way full bore ball valve, motorisable, with ISO 5211 flange, threaded ends F/F

2-Wege-Kugelhahn mit vollem Durchgang, motorisierbar, mit Flansch ISO 5211, IG/IG

Vanne à boisseau sphérique à passage intégral à 2 voies, motorisable, avec la bride ISO 5211, fixations F/F

Полнопроходной шаровой кран для привода, с двухходовым клапаном, фланец ISO 5211, соединения В/В



Cod./Code	DN	ISO 5211	□/田	€
123015001	1"1/2	F04	4/16	47,27
123020001	2"	F04	4/16	62,34

IVR 221



Valvola a sfera a passaggio totale motorizzabile, 2 vie, attacchi M/F
 2-way full bore ball valve, motorisable, threaded ends M/F
 2-Wege-Kugelhahn, motorisierbar, mit vollem Durchgang, AG/IG
 Vanne à boisseau sphérique à passage intégral à 2 voies, motorisable, fixations M/F
 Полнопроходной шаровой кран для привода, с двухходовым клапаном, соединения Н/В



Cod./Code	DN	Ø	□/田	€
122105010	1/2"	15	1/18	14,55
122107010	3/4"	20	1/18	18,79
122110010	1"	25	1/18	26,90
122112010	1"1/4	32	1/18	33,66

IVR 222



Valvola a sfera a passaggio totale motorizzabile, 2 vie, attacchi M/M
 2-way full bore ball valve, motorisable, M/M
 2-Wege-Kugelhahn, motorisierbar, mit vollem Durchgang, AG/AG
 Vanne à boisseau sphérique à passage intégral à 2 voies, motorisable, fixations M/M
 Полнопроходной шаровой кран для привода, с двухходовым клапаном, соединения Н/Н



Cod./Code	DN	Ø	□/田	€
122205010	1/2"	15	1/18	17,04
122207010	3/4"	20	1/18	22,19
122210010	1"	25	1/15	32,12
122212010	1"1/4	32	1/15	41,44

IVR 223



Valvola a sfera a passaggio totale motorizzabile - attacchi tubo rame compressione
 Full bore ball valve for actuator - with compression ends for copper pipe C/C
 Kugelhahn, motorisierbar, mit vollem Durchgang - Kompressionsanschluss für Kupferrohr
 Vanne à boisseau sphérique à passage intégral motorisable - fixations tube cuivre compression C/C
 Полнопроходной шаровой кран для привода - с компрессионным соединением для медной трубы



Cod./Code	DN	Ø	LM/MB	□/田	€
122315010	15	15		1/18	13,60
122322010	22	20		1/18	17,94
122328010	28	25		1/18	24,88

COMPACT MOTOR

Valvole di zona 3 vie deviatrici - 3 ways diverter zone valves

IVR 235



Valvola a sfera a passaggio totale, 3 vie deviatrici, motorizzabile, attacchi F/F/M

3-way diverting full bore ball valve, motorisable, threaded ends F/F/M

3-Wege-Ableitzoneventil, motorisierbar, IG/IG/AG

Vanne à boisseau sphérique à passage intégral déviateur à 3 voies, motorisable, fixations F/F/M

Полнопроходной шаровой кран для привода, с трехходовым клапаном распределителем, соединения В/В/Н

Cod./Code	DN	Ø	□/⊕	€
123507010	3/4"	20	1/15	25,08
123510010	1"	25	1/15	34,84



IVR 236



Valvola a sfera a passaggio totale, 3 vie deviatrici, motorizzabile, attacchi M/F/M

3-way diverting full bore ball valve, motorisable, threaded ends M/F/M

3-Wege-Ableitzoneventil, motorisierbar, AG/IG/AG

Vanne à boisseau sphérique à passage intégral déviateur à 3 voies, motorisable, fixations M/F/M

Полнопроходной шаровой кран для привода, с трехходовым клапаном распределителем, соединения Н/В/Н

Cod./Code	DN	Ø	□/⊕	€
123607010	3/4"	20	1/15	28,19
123610010	1"	25	1/15	39,57



IVR 237



Valvola a sfera a passaggio totale, 3 vie deviatrice, motorizzabile, attacchi M/M/M

3-way diverting full bore ball valve, motorisable, threaded ends M/M/M

3-Wege-Ableitzonventil, motorisierbar, AG/AG/AG

Vanne à boisseau sphérique à passage intégral déviatrice à 3 voies, motorisable, fixations M/M/M

Полнопроходной шаровой кран для привода, с трехходовым клапаном распределителем, соединения Н/Н/Н

Cod./Code	DN	Ø	□/田	€
123707010	3/4"	20	1/15	31,51
123710010	1"	25	1/15	44,90

IVR 238



Valvola a sfera a passaggio totale, 3 vie deviatrice, motorizzabile, attacchi tubo rame a compressione C/C/M

3-way full bore ball valve, motorisable, compression ends for copper pipe

3-Wege-Ableitzonventil, motorisierbar, Kompressionanschlüsse für Kupferrohr

Vanne à boisseau sphérique à passage intégral déviatrice à 3 voies, motorisable, fixations tube cuivre à compression

Полнопроходной шаровой кран для привода, с трехходовым клапаном распределителем, с компрессионным соединением для медной трубы - Н

Cod./Code	DN	Ø	LM/MB	□/田	€
123822010	22 x 22 x 1"	20		1/18	27,13
123828010	28 x 28 x 1"	25		1/15	37,09

COMPACT MOTOR

Valvole di zona 3 vie by-pass - 3 ways by-pass zone valves

IVR 240



Valvola a sfera a passaggio totale, con by-pass, motorizzabile, attacchi F/F/M

Full bore ball valve with by-pass, motorisable, threaded ends F/F/M

Kugelhahn mit vollem Durchgang, mit Bypass, motorisierbar, IG/IG/AG

Vanne à boisseau sphérique à passage intégral, avec by-pass, motorisable, fixations F/F/M

Полнопроходной шаровой кран для привода, с бай-пасс, соединения В/В/Н

Cod./Code	DN	Ø	□/田	€
124007010	3/4"	20	1/18	28,19
124010010	1"	25	1/15	42,02

IVR 241



Valvola a sfera a passaggio totale, 3 vie con by-pass, motorizzabile, attacchi M/F/M

Full bore ball valve with by-pass, motorisable, threaded ends M/F/M

3-Wege-Kugelhahn mit vollem Durchgang mit Bypass, motorisierbar, AG/IG/AG

Vanne à boisseau sphérique à passage intégral à 3 voies, avec by-pass, motorisable, fixations M/F/M

Полнопроходной шаровой кран для привода, с трехходовым клапаном, с бай-пасс, соединения Н/В/Н

Cod./Code	DN	Ø	□/田	€
124107010	3/4"	20	1/15	24,80
124110010	1"	25	1/15	36,75

IVR 242

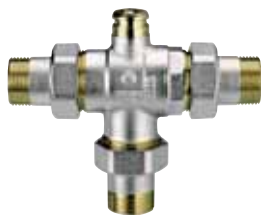

Valvola a sfera a passaggio totale, 3 vie con by-pass, motorizzabile, attacchi M/M/M

3-way full bore ball valve with by-pass, motorisable, threaded ends M/M/M

3-Wege-Kugelhahn mit vollem Durchgang mit Bypass, motorisierbar, AG/AG/AG

Vanne à boisseau sphérique à passage intégral à 3 voies, avec by-pass, motorisable, fixations M/M/M

Полнопроходной шаровой кран для привода с трехходовым клапаном, с бай-пасс, соединения Н/Н/Н

Cod./Code	DN	Ø	□/田	€
124207010	3/4"	20	1/15	28,16
124210010	1"	25	1/15	41,97

IVR 243



Valvola a sfera a passaggio totale, 3 vie con by-pass, motorizzabile, attacchi tubo rame a compressione C/C/M

3-way full bore ball valve with by-pass, motorisable, compression ends for copper pipe

3-Wege-Kugelhahn mit vollem Durchgang mit Bypass, motorisierbar, Kompressionanschlüsse für Kupferrohr

Vanne à boisseau sphérique à passage intégral à 3 voies, avec by-pass, motorisable, fixations tube cuivre à compression

Полнопроходной шаровой кран для привода, с трехходовым клапаном бай-пасс, компрессионным соединениям для медной трубы - Н

Cod./Code	DN	Ø	LM/MB	□/田	€
124322010	22 x 22 x 1"	20		1/18	23,74
124328010	28 x 28 x 1"	25		1/15	34,28

In accordo alle Direttive Europee
 According to European Directive
 98/37 CEE:198
 2006/95/CE 12/12/2006
 04/108/CEE:2004, 92/31/CEE:1992
 93/68/CEE:1993, 93/97/CEE:1993

MOTORHEAD

IVR 215 UB



Servomotori utilizzati per accoppiamento con valvole COMPACT MOTOR

Actuators suitable for COMPACT MOTOR ball valves

Verwendete Servomotoren für Kupplung mit COMPACT MOTOR Ventilen

Servomoteurs utilisés pour l'accouplement avec des vannes COMPACT MOTOR

Приводы используются с клапанами COMPACT MOTOR

OPZIONI:

- Su richiesta versione con tempi di manovra veloci
- Su richiesta versione 110V

Lotto minimo 20 pz.

OPZIONAL:

- Version with fast operating time on request
- 110V version on request

Minimum quantity 20 pcs.

OPTIONEN:

- 110V Version mit schnellen Betätigungszeiten auf Wunsch

Mindestabnahme 20 Stk

OPTIONS:

- Version 110V et/o version avec temps rapide de manoeuvre rapides sur demande

Lot minimum 20 pièces

ОПЦИИ:

- Возможен заказ версии для 110V и/или с повышенной скоростью работы

Минимум 20 шт

IVR 215 Motorehad servocomando per valvole serie "COMPACT MOTOR" uni-bidirezionale (on-off), comando a 2 punti con relè, 1 micro supplementare libero in apertura di serie

IVR 215 MOTORHEAD actuator for the valve series "COMPACT MOTOR" uni-bidirectional (on-off), 2 contact terminals with relay, 1 auxiliary microswitch included, free on opening

IVR 215 Motorhead für die Serie "COMPACT MOTOR", uni-bidirektional (On-Off), 2-Punkt-Steuerung mit Relais, mit einem zusätzlichen Mikroschalter beim Öffnen ausgestattet

IVR 215 Motorhead servocommande pour les vannes "COMPACT MOTOR", uni-bidirectionnelle (on-off), 2 points, avec relais, 1 micro-interrupteur supplémentaire inclus, libre en ouverture

IVR 215 Motorhead сервопривод для клапанов серии "COMPACT MOTOR", одно-двухнаправленный (on-off), 2 контактных зажима с реле, 1 вспомогательный микровыключатель свободный для подключения.

- Comando a 2 punti con relè : un singolo comando può azionare più servocomandi
- 2 contact terminals with relay: a single control device can operate several actuators
- 2-Punkt-Steuerung: kann mehrere Servosteuerungen betätigen
- Commande à 2 points: peut actionner plusieurs servocommandes
- 2 контактных зажима: можно подключать несколько приводов

Cod./Code	Vie/Way	Alim./Power Sup.	Coppia/Torque	Tem./Time	◁	□/田	€
121538041	2 - 3 • 3 by pass	230V 50/60 Hz	8 Nm	45 sec.	90°	1/15	82,54
121518041	2 - 3 • 3 by pass	24V 50/60 Hz	8 Nm	45 sec.	90°	1/15	82,54

IVR 215 B

IVR 215 Motorhead servocomando per valvole serie "COMPACT MOTOR" bidirezionale, comando a 3 punti, 1 micro supplementare libero in apertura di serie

IVR 215 Motorhead actuator for the series "COMPACT MOTOR" bidirectional, 3 contact terminals, 1 auxiliary microswitch included, free on opening

IVR 215 Motorhead für die Serie "COMPACT MOTOR", uni-bidirektional, 3-Punkt-Steuerung mit Relais, mit einem zusätzlichen Mikroschalter beim Öffnen ausgestattet

IVR 215 Motorhead servocommande pour les vannes "COMPACT MOTOR", uni-bidirectionnelle, 3 points, avec relais, 1 micro-interrupteur supplémentaire inclus, libre en position d'ouverture

IVR 215 Motorhead сервопривод для клапанов серии "COMPACT MOTOR", двухнаправленный, 3 контактных зажима, 1 вспомогательный микровыключатель свободный для подключения

- Comando a 3 punti: un singolo comando può azionare un solo servocomando
- 3 contact terminals: a single control device can operate only one actuator
- 3-Punkt-Steuerung: kann nur eine Servosteuerung betätigen
- Commande à 3 points: peut actionner plusieurs servocommandes
- 3 контактных зажима: можно подключать только один привод

Cod./Code	Vie/Way	Alim./Power Sup.	Coppia/Torque	Tem./Time	◁	□/田	€
121538020	2 - 3 • 3 by pass	230V 50/60 Hz	8 Nm	35 sec.	90°	1/15	101,03
121518020	2 - 3 • 3 by pass	24V 50/60 Hz	8 Nm	35 sec.	90°	1/15	102,61

IVR 215/D



Distanziale per isolamento termico per IVR 215

Thermal insulation box for IVR215

Thermische Isolierbox für IVR 215

Coque d'isolation thermique IVR 215

Теплоизоляционная коробка для IVR 215

Cod./Code	□/田	€
121501001	10/180	24,75

IVR 217 3P



Servomotori utilizzati per accoppiamento con valvole AUTOMAT L

Actuators suitable for AUTOMAT L ball valves

Verwendete Servomotoren für Kupplung mit AUTOMAT L -

Kügelhähne

Servomoteurs utilisés pour l'accouplement avec des vannes

AUTOMAT L

Приводы используются с клапанами AUTOMAT L

IVR 217 Motorhead ISO 5211, per valvole serie Automat L, bidirezionale, comando a 3, 1 micro supplementare libero in apertura di serie

IVR 217 Motorhead ISO 5211 for Automat L valves, bidirectional, 3 contact terminals, 1 auxiliary microswitch included, free on opening

IVR 217 Motorhead ISO 5211, für die Kugelventile der Serie Automat L, bidirektional, mit 3-Punkt-Steuerung und mit einem zusätzlichen Mikroschalter beim Öffnen ausgestattet

IVR 217 Motorhead ISO 5211 pour les vannes Automat L, bidirectionnelle, 3 points, 1 micro-interrupteur inclus libre en position d'ouverture

IVR 217 Motorhead ISO 5211 для кранов серии Automat L, двунаправленный, 3 контактных зажима, 1 вспомогательный микровыключатель свободный для подключения

- Comando a 3 punti: un singolo comando può azionare un solo servocomando
- 3 contact terminals: a single control device can operate only one actuator
- 3-Punkt-Steuerung: kann nur eine Servosteuerung betätigen
- Commande à 3 points: peut actionner plusieurs servocommandes
- 3 контактных зажима: можно подключать только один привод

Cod./Code	ISO 5211	Alim./Power Sup.	Coppia/Torque	Tem./Time			€
121743520	F04	230 V 50/60 Hz	14 Nm	35 sec.	90°	1/8	155,48



FLANGIA ISO

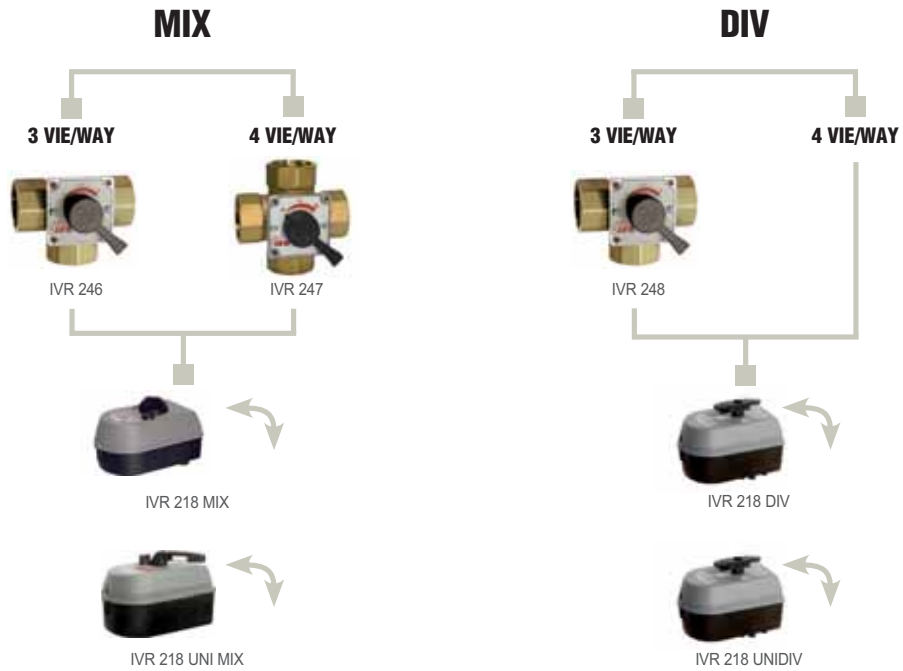

ATTACCO RAPIDO (EASY)



AUTOMAT MIX + MOTORHEAD MIX

IVR 246 + IVR 218 MIX



IVR 246 - Valvola miscelatrice rotante a tre vie in ottone - attacchi F/F/F + MOTORHEAD 218 MIX - Servocomando bidirezionale per valvole miscelatrici rotanti- 230 V - 3 punti

IVR 246 - 3-way rotary mixing valve in brass - F/F/F + MOTORHEAD IVR 218 MIX - Electrical actuators bidirectional for rotary mixing valves - 230 V - 3 point control

IVR 246 - drehbares 3-Wege-Mischventil aus Messing - IG/IG/IG + Motorhead 218 MIX - bidirektionale Servosteuerung für drehbare Mischventile - 230V - 3 Punkt-Steuerung

IVR 246 - vanne trois voies mélangeuse tournante - F/F/F + Motorhead 218 MIX - actionneur électrique bidirectionnel pour vannes mélangeuses tournantes - 230 V - contrôle de 3 points

IVR 246 - трехходовой поворотный смесительный клапан из латуни .Соединение: резьба В/В/В + MOTORHEAD 218 MIX - двунаправленный сервопривод для смесительных поворотных шаровых кранов - 230 V - 3 контактных зажима



Cod./Code	Misure/Size	□/⊞	€
424605005	MHM 105s + AUTOMAT MIX 3V 1/2"	1/9	125,63
424607005	MHM 105s + AUTOMAT MIX 3V 3/4"	1/9	129,38
424610005	MHM 105s + AUTOMAT MIX 3V 1"	1/9	132,00
424612005	MHM 105s + AUTOMAT MIX 3V 1"1/4	1/9	138,38
424605010	MHM 210s + AUTOMAT MIX 3V 1/2"	1/9	125,63
424607010	MHM 210s + AUTOMAT MIX 3V 3/4"	1/9	129,38
424610010	MHM 210s + AUTOMAT MIX 3V 1"	1/9	132,00
424612010	MHM 210s + AUTOMAT MIX 3V 1"1/4	1/9	138,38

EAC

IVR 247 + IVR 218 MIX



IVR 247 - Valvola miscelatrice rotante a quattro vie in ottone - attacchi F/F/F/F + MOTORHEAD IVR 218 MIX - Servocomando bidirezionale per valvole miscelatrici rotanti- 230 V - 3 punti

IVR 247 - 4-way rotary mixing valve - F/F/F/F + MOTORHEAD IVR 218 MIX - Electrical actuators bidirectional for rotary mixing valves - 230 V - 3 point control

IVR 247 drehbares 4-Wege-Mischventil - aus Messing - IG/IG/IG/IG + Motorhead IVR 218 MIX - bidirektionale Servosteuerung für drehbares Mischventile - 230 V - 3 Punkt-Steuerung

IVR 247 - vanne quatre voies mélangeuse tournante - F/F/F/F + Motorhead IVR 218 MIX - actionneur électrique bidirectionnel pour vannes mélangeuses tournantes- 230 V - contrôle de 3 points

IVR 247 - четырехходовой поворотный смесительный клапан из латуни. Соединение: резьба В/В/В/В + MOTORHEAD 218 MIX - двунаправленный сервопривод для смесительных поворотных шаровых кранов - 230 V - 3 контактных зажима



Cod./Code	Misure/Size	□/⊞	€
424705005	MHM 105s + AUTOMAT MIX 4V 1/2"	1/9	125,63
424707005	MHM 105s + AUTOMAT MIX 4V 3/4"	1/9	129,38
424710005	MHM 105s + AUTOMAT MIX 4V 1"	1/9	132,00
424712005	MHM 105s + AUTOMAT MIX 4V 1"1/4	1/9	138,38
424705010	MHM 210s + AUTOMAT MIX 4V 1/2"	1/9	125,63
424707010	MHM 210s + AUTOMAT MIX 4V 3/4"	1/9	129,38
424710010	MHM 210s + AUTOMAT MIX 4V 1"	1/9	132,00
424712010	MHM 210s + AUTOMAT MIX 4V 1"1/4	1/9	138,38

EAC

AUTOMAT MIX

IVR 246



EAC



Valvola miscelatrice rotante a tre vie in ottone - attacchi F/F/F
 3-way brass rotary mixing valve in brass - F/F/F
 Drehbares 3-Wege-Mischventil - aus Messing - IG/IG/IG
 Vanne trois voies mélangeuse tournante en laiton - F/F/F
 Трехходовой латунный поворотный смесительный клапан. Соединение: резьба В/В/В

Cod./Code	DN	Ø	□/⊕	€
124605001	1/2"	15	1/28	43,13
124607001	3/4"	20	1/28	52,13
124610001	1"	25	1/20	54,38
124612001	1 1/4"	32	1/20	58,13

IVR 247



EAC



Valvola miscelatrice rotante a quattro vie in ottone - attacchi F/F/F/F
 4-way brass rotary mixing valve in brass - F/F/F/F
 Drehbares 4-Wege-Mischventil - aus Messing - IG/IG/IG/IG
 Vanne quatre voies mélangeuse tournante en laiton - F/F/F/F
 Четырехходовой поворотный смесительный клапан из латуни. Соединение: резьба В/В/В/В

Cod./Code	DN	Ø	□/⊕	€
124705001	1/2"	15	1/28	43,13
124707001	3/4"	20	1/28	52,13
124710001	1"	25	1/20	54,38
124712001	1 1/4"	32	1/20	58,13

MOTORHEAD MIX / UNIMIX

IVR 218 MIX



IVR 218 MIX MOTORHEAD - Servocomando bidirezionale per valvole miscelatrici rotanti - 230 V - 3 punti
 IVR 218 MIX MOTORHEAD - Electrical actuators bidirectional for mixing rotary valves - 230 V - 3 point control
 IVR 218 MIX MOTORHEAD - bidirektionale Servosteuerung für Dreh-Mischventile - 230 V - 3 Punkt-Steuerung
 IVR 218 MIX MOTORHEAD - actionneur électrique double-directionnel pour vannes mélangeuses à rotor - 230 V - 3 points
 IVR 218 MIX MOTORHEAD - двунаправленный сервопривод для смесительных поворотных клапанов - 230 V - 3 контактных зажима



Cod./Code	Vie/Way	Alim./Power Sup.	Coppia/Torque	Tem./Time	◁	□/⊞	€
121803005	3 - 4 vie / 3- 4 ways	230V 50/60 Hz	8 Nm	105 sec.	90°	1/9	88,13
121803010	3 - 4 vie / 3- 4 ways	230V 50/60 Hz	8 Nm	210 sec.	90°	1/9	88,13

IVR 218 UNI MIX



IVR 218 MOTORHEAD UNIMIX - Servocomando bidirezionale per valvole miscelatrici rotanti a sfera - 230 V - 3 punti
 IVR 218 MOTORHEAD UNIMIX - Electrical actuators bidirectional for mixing rotary ball valve - 230 V - 3 point control
 IVR 218 MOTORHEAD UNIMIX - bidirektionale Servosteuerung für Dreh-Mischventile - 230 V - 3 Punkt-Steuerung
 IVR 218 MOTORHEAD UNIMIX - actionneur électrique double-directionnel pour vannes mélangeuses à rotor - 230 V - 3 points
 IVR 218 MOTORHEAD UNIMIX - двунаправленный сервопривод для смесительных поворотных клапанов - 230 V - 3 контактных зажима



Cod./Code	Vie/Way	Alim./Power Sup.	Coppia/Torque	Tem./Time	◁	□/⊞	€
121803320	3 - 4 vie / 3- 4 ways	230V 50/60 Hz	8 Nm	73 sec.	90°	1/9	91,88
121803330	3 - 4 vie / 3- 4 ways	230V 50/60 Hz	8 Nm	147 sec.	90°	1/9	93,38

AUTOMAT DIV + MOTORHEAD DIV

IVR 248 + IVR 218 DIV



IVR 248 - Valvola deviatrice rotante a 3 vie in ottone - attacchi F/F/F + MOTORHEAD 218 DIV - servocomando bidirezionale rotazione non definite per valvole deviatrici rotanti - 230 V con relè - 2 punti

IVR 248 - 3-way rotary diverter valve in brass - F/F/F + MOTORHEAD 218 DIV - Electrical actuators with undefined rotation bidirectional for diverting rotary valves - 230 V - 2 point control with relay

IVR 248 - drehbares 3 Wege-Ableitventil aus Messing- IG/IG/IG + Motorhead 218 DIV - bidirektionale Servosteuerung - unbestimmte Schwenkung für drehbare Ableitventile - 230V mit Relais - 2 Punkt

IVR 248 - vanne déviatrice trois voies - F/F/F + Motorhead 218 DIV - actionneur électrique avec rotation indéfinie bidirectionnelle pour vannes déviateurs tournantes - 230 V - avec relais - contrôle de 2 points

IVR 248 - трехходовой поворотный распределительный клапан из латуни. Соединение: В/В/В + MOTORHEAD 218 DIV - двунаправленный сервопривод для смесительных поворотных клапанов - 230 V с реле - 2 контактных зажима



Cod./Code	Misure/Size	□/田	€
424805050	MHD 18s + AUTOMAT DIV 3V 1/2"	1/9	106,88
424807050	MHD 18s + AUTOMAT DIV 3V 3/4"	1/9	112,13
424810050	MHD 18s + AUTOMAT DIV 3V 1"	1/9	114,38
424812050	MHD 18s + AUTOMAT DIV 3V 1"1/4	1/9	119,63

AUTOMAT DIV

IVR 248



Valvola deviatrice rotante a tre vie in ottone - attacchi F/F/F

3-way rotary diverter valve in brass - F/F/F

Drehbares 3-Wege-Ableitventil aus Messing - IG/IG/IG

Vanne déviatrice tournante trois voies tournante - F/F/F

Трехходовой распределительный поворотный латунный клапан. Соединение: В/В/В



Cod./Code	DN	Ø	□/田	€
124805001	1/2"	15	1/28	43,13
124807001	3/4"	20	1/28	52,13
124810001	1"	25	1/20	54,38
124812001	1"1/4	32	1/20	58,88

MOTORHEAD DIV / UNI DIV

IVR 218 DIV



IVR 218 MOTORHEAD DIV - Servocomando bidirezionale rotazione non definita per valvole deviatrici rotanti - 230 V - con relé - 2 punti

IVR 218 MOTORHEAD DIV - Electrical actuators undefined rotation bidirectional for diverting rotary valve - 230 V - with relay - 2 point control

IVR 218 MOTORHEAD DIV - bidirektionale Servosteuerung - nicht bestimmte Schwenkung für Dreh - Steuerventile - 230 V mit Relais - 2 Punkt-Steuerung

IVR 218 MOTORHEAD DIV - actionneur électrique double-directionnel avec rotation indéfinie pour vannes de répartition à rotor - 230 V - avec relé - 2 points

IVR 218 MOTORHEAD DIV - двунаправленный сервопривод для распределительных поворотных клапанов - 230 V - с реле - 2 контактных зажима

EAC



Cod./Code	Vie/Way	Alim./Power Sup.	Coppia/Torque	Tem./Time	◁	□/⊞	€
121803050	3 vie / 3 ways	230V 50/60 Hz	8 Nm	18 sec.	90°	1/9	73,13

IVR 218 UNI DIV



IVE 218 MOTORHEAD UNI DIV - Servocomando bidirezionale per valvole deviatrici rotanti a sfera - 230 V - con relé - 2 punti

IVE 218 MOTORHEAD UNI DIV - Electrical actuators bidirectional for diverting rotary ball valve - 230 V - with relay - 2 point control

IVE 218 MOTORHEAD UNI DIV - bidirektionale Servosteuerung für Dreh - Steuerventile - 230V mit Relais - 2 Punkt-Steuerung

IVE 218 MOTORHEAD UNI DIV - actionneur électrique double-directionnel pour vannes de répartition à rotor - 230 V - avec relé - 2 points

IVE 218 MOTORHEAD UNI DIV - двунаправленный сервопривод для распределительных поворотных клапанов - 230 V - с реле - 2 контактных зажима

EAC



Cod./Code	Vie/Way	Alim./Power Sup.	Coppia/Torque	Tem./Time	◁	□/⊞	€
121803205	3 - 4 vie / 3- 4 ways	230V 50/60 Hz	10 Nm	16 sec.	90°	1/9	82,13

AUTOMAT MIX EASY + MOTORHEAD MIX EASY

IVR 245 MIX EASY + IVR 215 MIX EASY



IVR 245 - Valvola miscelatrice rotante a tre vie in ottone - attacchi F/F/F + MOTORHEAD 215 MIX EASY - Servocomando bidirezionale rotazione non definita per valvole miscelatrici rotanti - 230 V - 3 punti

IVR 245 - 3-way rotary mixing valve in brass - F/F/F + MOTORHEAD 215 MIX EASY - bidirectional electrical actuator with undefined rotation for mixing rotary valves - 230 V - 3 point control

IVR 245 - drehbares 3-Wege-Mischventil - aus Messing - IG/IG/IG + MOTORHEAD 215 MIX EASY - bidirektionale Servosteuerung - unbestimmte Schwenkung für drehbares Mischventile - 230 V - 3 Punkt

IVR 245 - vanne mélangeuse trois voies tournante - F/F/F + MOTORHEAD 215 MIX EASY - actionneur électrique bidirectionnel avec rotation indéfinie pour vannes mélangeuses tournantes - 230 V - 3 contrôle du point

IVR 245 - трехходовой поворотный смесительный клапан из латуни. Соединение: резьба В/В/В + MOTORHEAD 215 MIX EASY - Двухнаправленный сервопривод для смесительных поворотных клапанов - 230 V - 3 контактных зажима



Cod./Code	Misure/Size	□/田	€
424507110	MHMEASY 230 V 110s MIX 3V 3/4"	1/9	108,75
424510110	MHMEASY 230 V 110s MIX 3V 1"	1/9	112,50

AUTOMAT MIX EASY

IVR 245 MIX EASY



Valvola miscelatrice rotante a tre vie in ottone - attacchi F/F/F

3-way rotary mixing valve in brass - F/F/F

Drehbares 3-Wege-Ableitventil aus Messing - IG/IG/IG

Vanne mélangeuse trois voies tournante - F/F/F

Трехходовой поворотный распределительный клапан из латуни. Соединение: резьба В/В/В



Cod./Code	Misure/Size	□/田	€
124507001	3/4" VALV 3V AUTOMAT EASY-MIX	1/9	40,88
124510001	1" VALV 3V AUTOMAT EASY-MIX	1/9	54,38

MOTORHEAD MIX EASY

IVR 215 MIX EASY



Servocomando bidirezionale rotazione non definita per valvole miscelatrici rotanti - 230 V - 3 punti

Bidirectional electrical actuator with undefined rotation for mixing rotary valve - 230 V - 3 point control

Bidirektionale Servosteuerung - nicht bestimmte Schwenkung für Dreh-Mischventile - 230V - 3 Punkt-Steuerung

Actionneur électrique double-directionnel avec rotation indéfinie pour vannes mélangeuses à rotor - 230 V - 3 contrôle du point

Двухнаправленный сервопривод для смесительных поворотных клапанов - 230 V - с реле - 3 контактных зажима



Cod./Code	Misure/Size	□/田	€
121503110	MOTORHEAD EASY-MIX 230 V 110s	1/9	60,00

AUTOMAT DIV EASY + MOTORHEAD DIV EASY

IVR 249 DIV EASY + IVR 215 DIV EASY



IVR 249 - Valvola deviatrice rotante a tre vie in ottone - attacchi F/F/F + MOTORHEAD 215 DIV EASY
 Servocomando bidirezionale rotazione non definita per valvole deviatrici rotanti - 230 V - con relé - 2 punti

IVR 249 - 3-way rotary diverter valve in brass - F/F/F + MOTORHEAD 215 DIV EASY Electrical actuators with
 undefined rotation bidirectional for rotary diverter valves - 230 V - with relay - 2 point control

IVR 249 - drehbares 3 Wege-Ableitventil aus Messing - IG/IG/IG + MOTORHEAD 215 DIV EASY bidirektionale
 Servosteuerung - unbestimmte Schwenkung für Ableitventile - 230V mit Relais - 2 Punkt

IVR 249 - vanne déviatrice trois voies tournante - F/F/F + MOTORHEAD 215 DIV EASY - actionneur électrique
 bidirectionnel avec rotation indéfinie pour vannes déviateurs tournantes- 230 V - 3 contrôle du point

IVR 249 - трехходовой поворотный распределительный клапан из латуни. Соединение: резьба В/В/В
 + MOTORHEAD 215 DIV EASY - Двухнаправленный сервопривод для распределительных поворотных
 клапанов - 230 V - с реле - 2 контактных зажима

ERC



Cod./Code	Misure/Size	□/田	€
424907013	MHDEASY 230 V 13s DIV 3V 3/4"	1/9	108,75
424910013	MHDEASY 230 V 13s DIV 3V 1"	1/9	112,50

AUTOMAT DIV EASY

IVR 249 DIV EASY



Valvola deviatrice rotante a tre vie in ottone - attacchi F/F/F

3-way rotary diverter valve in brass - F/F/F

Drehbares 3-Wege-Ableitventil aus Messing - IG/IG/IG

Vanne déviatrice trois voies tournante en laiton - F/F/F

Трехходовой поворотный распределительный клапан из латуни. Соединение: резьба В/В/В

ERC



Cod./Code	Misure/Size	□/田	€
124907001	3/4" VALV 3V AUTOMAT EASY-DIV	1/10	52,13
124910001	1" VALV 3V AUTOMAT EASY-DIV	1/10	54,38

MOTORHEAD DIV EASY

IVR 215 DIV EASY



Servocomando bidirezionale rotazione non definita per valvole deviatrici rotanti - 230 V - con relé - 2 punti

Electrical actuators with undefined rotation bidirectional for diverter rotary valves - 230 V - with relay - 2 point
 control

Bidirektionale Servosteuerung - unbestimmte Schwenkung für Ableitventile - 230V mit Relais - 2 Punkt

Actionneur électrique bidirectionnel avec rotation indéfinie pour vannes déviateurs tournantes- 230 V - 3 contrôle
 du point

Двухнаправленный сервопривод для смесительных поворотных клапанов - 230 V - с реле - 2 контактных
 зажима

ERC



Cod./Code	Misure/Size	□/田	€
121503013	MOTORHEAD EASY-DIV 230 V 13s	1/9	60,00

CAST MIX + MOTORHEAD UNIMIX

IVR 990



Componenti di controllo e regolazione della temperatura per valvole di miscelazione
 Components for control and setting of the temperature for mixing valves
 Zubehör zur Kontrolle und Regelung der Temperatur für Mischventile
 Composants de contrôle et de régulation de la température pour les vannes de mélange
 Компоненты контроля и регулировки температуры для смесительных клапанов



Cod./Code	Misure/Size	□/田	€
199000001	CENTRALINA ROTOTERM MR-TR	1	232,50
199000010	CRONOTERMOSTATO AS2000	1	112,50
199000020	TERMOSTATO SK3	1	30,00



Applicazioni es./Applications ex.:
 Sistema ACS con impianto solare
 Domestic hot waters system with solar collector

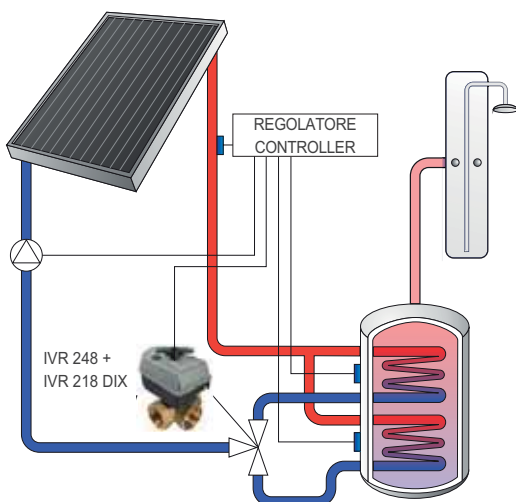

Riscaldamento con caldaia e radiatori
 Radiator heating with gas boiler

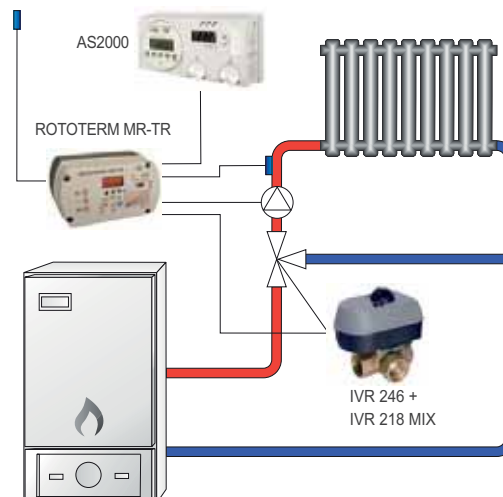



VALVOLE ACQUA
WATER VALVES
KUGELHÄHNE FÜR WASSER
VANNES EAU
ЗАПОРНАЯ АРМАТУРА ДЛЯ ВОДЫ



Valvole in ottone per acqua

Brass water valves



Top p. 137

Export Plus p. 139

Export p. 140

Everlast Plus p. 149



Everlast p. 150

Everwater Plus p. 158

Everwater p. 159



Evermid p. 164

Elite GW 4MS p. 172

Elite GW 4MS Kiwa p. 175



Solar Line p. 178

NPT p. 181

DZR p. 182

Nordika p. 185



Valvola con bocchettone - Valve with tail piece p. 187

Valvola a sfera con portasonda - Ball valves with sensor connection p. 188

Valvola a sfera a tre - 3-way valve p. 191



Valvole attacco pompa - Valves for pump connection p. 193

Valvole di ritegno e raccoglitori di impurità - Check valves and strainers p. 202

Saracinesche - Gate valves p. 206

Riduttori di pressione - Pressure reducing valves p. 208



Raccordi - Fittings p. 210

Filtro autopulente - Self-cleaning filter p. 216



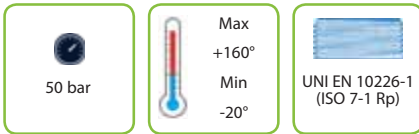

IVR TOP

IVR 48 TOP



Valvola a sfera a passaggio totale - attacchi F/F
Full bore ball valve - threaded ends F/F
Kugelhahn mit vollem Durchgang - IG/IG
Vanne à boisseau sphérique à passage intégral - Fixations F/F
Полнопроходной шаровой кран - Соединения В/В

Cod./Code	DN	Ø	□/田	€
104803024	3/8"	10	10/120	5,63
104805024	1/2"	15	5/60	8,45
104807024	3/4	20	15/60	11,02
104810024	1"	25	10/40	19,17
104812024	1 1/4	32	4/16	28,13
104815024	1 1/2	40	4/16	40,33
104820024	2"	50	2/8	63,69

EAC

IVR 48/A TOP



Valvola a sfera a passaggio totale - attacchi F/F
Full bore ball valve - threaded ends F/F
Kugelhahn mit vollem Durchgang - IG/IG
Vanne à boisseau sphérique à passage intégral - fixations F/F
Полнопроходной шаровой кран - Соединения В/В

Cod./Code	DN	Ø	□/田	€
104803021	3/8"	10	10/120	5,08
104805021	1/2"	15	5/60	8,02
104807021	3/4	20	15/60	10,58
104810021	1"	25	10/40	17,68

EAC

IVR 49 TOP



Valvola a sfera a passaggio totale - attacchi M/F
Full bore ball valve - threaded ends M/F
Kugelhahn mit vollem Durchgang - AG/IG
Vanne à boisseau sphérique à passage intégral - fixations M/F
Полнопроходной шаровой кран - Соединения Н/В

Cod./Code	DN	Ø	□/田	€
104903024	3/8"	10	10/120	5,73
104905024	1/2"	15	5/60	8,60
104907024	3/4	20	15/60	11,46
104910024	1"	25	10/40	19,39
104912024	1 1/4	32	4/16	28,47
104915024	1 1/2	40	4/16	42,25
104920024	2"	50	2/8	63,76



EAC

IVR 49/A TOP



Valvola a sfera a passaggio totale - attacchi M/F
Full bore ball valve - threaded ends M/F
Kugelhahn mit vollem Durchgang - AG/IG
Vanne à boisseau sphérique à passage intégral - fixations M/F
Полнопроходной шаровой кран - Соединения Н/В





Cod./Code	DN	Ø	□/田	€
104903021	3/8"	10	10/120	5,18
104905021	1/2"	15	5/60	8,16
104907021	3/4	20	15/60	11,02
104910021	1"	25	10/40	17,90

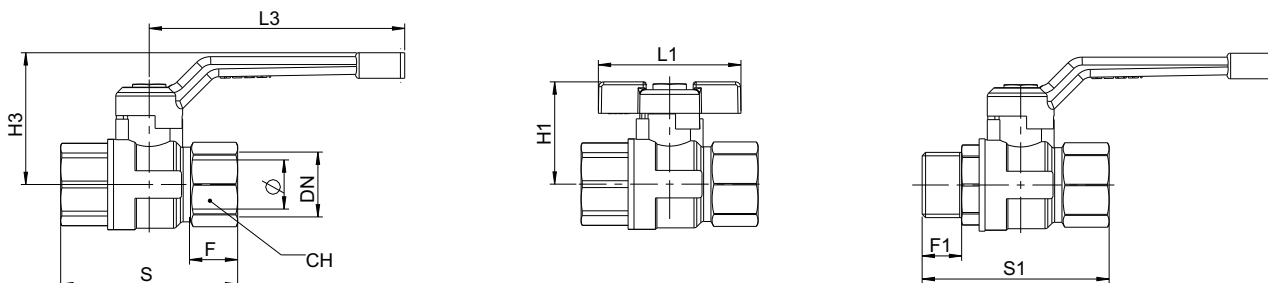

EAC



TOP															
DIMENSIONI / DIMENSIONS															
DN	Ø	S	S1	S2	L	L1	L2	L3	H	H1	H2	H3	F	F1	CH
3/8"	10	60	61			50		85		33		44	19	12	22
1/2"	15	75	76			61		110		39		52	23	15	26
3/4"	20	80	85			61		110		43		55	23,5	17	31
1"	25	90	95			72		130		52		67	24,5	20	40
1"1/4	32	110	111					130				72	31	22,5	49
1"1/2	40	120	125					160				90	32	22,5	55
2"	50	141	144					160				95	36	26,5	68

TOP						
ACCESSORI / RICAMBI - ACCESSORIES / SPARE PARTS						
						
3/8"	700702001 € 0,95	703002001 € 0,56	750106001 € 0,43	125603440 € 1,94	125603600 € 1,94	109702030 € 5,30
1/2"	700712001 € 1,24	703012001 € 0,70	750108001 € 0,44	125605440 € 2,37	125605600 € 2,37	109705030 € 6,76
3/4"	700712001 € 1,24	703012001 € 0,70	750108001 € 0,44	125605440 € 2,37	125605600 € 2,37	109705030 € 6,76
1"	700722001 € 2,66	703022001 € 0,83	750110001 € 0,48	125610440 € 3,01	125610600 € 3,01	109710030 € 9,06
1"1/4	700722001 € 2,66		750110001 € 0,48	125610440 € 3,01	125610600 € 3,01	109710030 € 9,06
1"1/2	700732001 € 3,53		750114001 € 0,55	125615440 € 5,18	125615600 € 5,18	109715030 € 12,04
2"	700732001 € 3,53		750114001 € 0,55	125615440 € 5,18	125615600 € 5,18	109715030 € 12,04

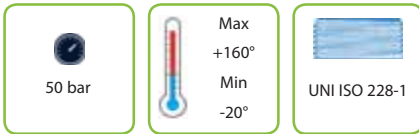

IVR EXPORT PLUS

IVR 45 PLUS



Valvola a sfera a passaggio totale - attacchi F/F

Full bore ball valve - threaded ends F/F

Kugelhahn mit vollem Durchgang - IG/IG

Vanne à boisseau sphérique à passage intégral - fixations F/F

Полнопроходной шаровой кран - Соединения В/В

Cod./Code	DN	Ø	□/田	€
104502851	1/4"	10	10/120	4,82
104503851	3/8"	10	10/120	4,41
104505851	1/2"	15	15/60	7,51
104507851	3/4"	20	15/60	10,15
104510851	1"	25	10/40	17,17
104512851	1"1/4	32	6/24	24,70
104515851	1"1/2	40	4/16	37,33
104520851	2"	50	2/8	56,94
104525487	2" 1/2	61	6	116,13 (*)
104530487	3"	74	4	164,85 (*)
104540487	4"	95	2	281,37 (*)



(*) Maniglia imbutita in acciaio
(*) Steel drawn handle
(*) Tiefgezogener Griff aus Stahl
(*) Poignée emboulée en acier
(*) Штампованная стальная ручка

IVR 46 PLUS



Valvola a sfera a passaggio totale - attacchi M/F

Full bore ball valve - threaded ends M/F

Kugelhahn mit vollem Durchgang - AG/IG

Vanne à boisseau sphérique à passage intégral - fixations M/F

Полнопроходной шаровой кран - Соединения Н/В

Cod./Code	DN	Ø	□/田	€
104602851	1/4"	10	10/120	4,01
104603851	3/8"	10	10/120	4,78
104605851	1/2"	15	12/72	7,82
104607851	3/4	20	15/60	10,61
104610851	1"	25	10/40	17,96
104612851	1"1/4	32	6/24	27,04
104615851	1"1/2	40	4/16	40,53
104620851	2"	50	2/8	60,07



IVR 47 PLUS



Valvola a sfera a passaggio totale - attacchi M/M

Full bore ball valve - threaded ends M/M

Kugelhahn mit vollem Durchgang - AG/AG

Vanne à boisseau sphérique à passage intégral - fixations M/M

Полнопроходной шаровой кран - Соединения Н/Н

Cod./Code	DN	Ø	□/田	€
195702334	1/4" ISO 228	10	10/120	4,49
195703334	3/8" ISO 228	10	10/120	4,46
104705851	1/2"	15	12/72	7,99
104707851	3/4	20	10/40	10,46
104710851	1"	25	10/40	18,44



IVR EXPORT

50 bar

Max
+160°
Min
-20°

UNI ISO 228-1

IVR 45



Valvola a sfera a passaggio totale - attacchi F/F, con maniglia rossa
Full bore ball valve - threaded ends F/F, with red handle
Kugelhahn mit vollem Durchgang - IG/IG, mit rotem Hebelgriff
Vanne à boisseau sphérique à passage intégral - fixations F/F, avec poignée rouge
Полнопроходной шаровой кран - Соединения В/В ,с красной ручкой

Cod./Code	DN	Ø	□/田	€
104502107	1/4"	10	10/120	4,57
104503107	3/8"	10	10/120	4,15
104505107	1/2"	15	12/72	7,19
104507107	3/4"	20	15/60	9,81
104510107	1"	25	10/40	15,92
104512107	1"1/4	32	6/24	23,46
104515107	1"1/2	40	4/16	35,73
104520107	2"	50	2/8	55,35
104525107	2"1/2	61	6	120,25
104530107	3"	74	4	168,98
104540107	4"	95	2	278,71



IVR 45 LB



Valvola a sfera a passaggio totale - attacchi F/F, con maniglia blu
Full bore ball valve - threaded ends F/F, with blue handle
Kugelhahn mit vollem Durchgang - IG/IG, mit blauem Hebelgriff
Vanne à boisseau sphérique à passage intégral - fixations F/F, avec poignée bleu
Полнопроходной шаровой кран - Соединения В/В,с голубой ручкой

SU RICHIESTA
ON DEMAND

Cod./Code	DN	Ø	□/田	€
104502209	1/4"	10	10/120	4,57
104503209	3/8"	10	10/120	4,15
104505209	1/2"	15	12/72	7,19
104507209	3/4"	20	15/60	9,81
104510209	1"	25	10/40	15,92
104512209	1"1/4	32	6/24	23,46
104515209	1"1/2	40	4/16	35,73
104520209	2"	50	2/8	55,35
104525209	2"1/2	61	6	120,25
104530209	3"	74	4	168,98
104540209	4"	95	2	278,71



NEW

IVR 45 LN



Valvola a sfera a passaggio totale - attacchi F/F, con maniglia nera
Full bore ball valve - threaded ends F/F, with black handle
Kugelhahn mit vollem Durchgang - IG/IG, mit schwarzem Hebelgriff
Vanne à boisseau sphérique à passage intégral - fixations F/F, avec poignée noire
Полнопроходной шаровой кран - Соединения В/В ,с чёрной ручкой

SU RICHIESTA
ON DEMAND

Cod./Code	DN	Ø	□/田	€
104502220	1/4"	10	10/120	4,57
104503220	3/8"	10	10/120	4,15
104505220	1/2"	15	12/72	7,19
104507220	3/4"	20	15/60	9,81
104510220	1"	25	10/40	15,92
104512220	1"1/4	32	6/24	23,46
104515220	1"1/2	40	4/16	35,73
104520220	2"	50	2/8	55,35
104525220	2"1/2	61	6	120,25
104530220	3"	74	4	168,98
104540220	4"	95	2	278,71



NEW

IVR 45/A



Valvola a sfera a passaggio totale - attacchi F/F, con farfalla rossa
Full bore ball valve - threaded ends F/F, with red butterfly handle
Kugelhahn mit vollem Durchgang - IG/IG, mit rotem Flügelgriff
Vanne à boisseau sphérique à passage intégral - fixations F/F, avec papillon rouge
Полнопроходной шаровой кран - Соединения В/В, с красной ручкой "бабочка"



Cod./Code	DN	Ø	□/田	€
104502004	1/4"	10	10/120	4,47
104503004	3/8"	10	10/120	4,08
104505004	1/2"	15	12/72	7,09
104507004	3/4"	20	15/60	9,72
104510004	1"	25	10/40	15,69

IVR 45/A FB



Valvola a sfera a passaggio totale - attacchi F/F, con farfalla blu
Full bore ball valve - threaded ends F/F, with blue butterfly handle
Kugelhahn mit vollem Durchgang - IG/IG, mit blauem Flügelgriff
Vanne à boisseau sphérique à passage intégral - fixations F/F, avec papillon bleu
Полнопроходной шаровой кран - Соединения В/В, с голубой ручкой "бабочка"



Cod./Code	DN	Ø	□/田	€
104502211	1/4"	10	10/120	4,47
104503211	3/8"	10	10/120	4,08
104505211	1/2"	15	12/72	7,09
104507211	3/4"	20	15/60	9,72
104510211	1"	25	10/40	15,69



IVR 45/A FN



Valvola a sfera a passaggio totale - attacchi F/F, con farfalla nera
Full bore ball valve - threaded ends F/F, with black butterfly handle
Kugelhahn mit vollem Durchgang - IG/IG, mit schwarzem Flügelgriff
Vanne à boisseau sphérique à passage intégral - fixations F/F, avec papillon noire
Полнопроходной шаровой кран - Соединения В/В, с чёрной ручкой "бабочка"



Cod./Code	DN	Ø	□/田	€
104502221	1/4"	10	10/120	4,47
104503221	3/8"	10	10/120	4,08
104505221	1/2"	15	12/72	7,09
104507221	3/4"	20	15/60	9,72
104510221	1"	25	10/40	15,69

IVR 46



Valvola a sfera a passaggio totale - attacchi M/F, con maniglia rossa
Full bore ball valve - threaded ends M/F, with red handle
Kugelhahn mit vollem Durchgang - AG/IG, mit rotem Hebelgriff
Vanne à boisseau sphérique à passage intégral - fixations M/F, avec poignée rouge
Полнопроходной шаровой кран - Соединения Н/В, с красной ручкой



Cod./Code	DN	Ø	□/田	€
104602006	1/4"	10	10/120	3,76
104603006	3/8"	10	10/120	4,53
104605006	1/2"	15	12/72	7,49
104607006	3/4"	20	15/60	10,27
104610006	1"	25	10/40	16,75
104612006	1"1/4	32	6/24	25,80
104615006	1"1/2	40	4/16	38,93
104620006	2"	50	2/8	58,48

IVR 46 LB



Valvola a sfera a passaggio totale - attacchi M/F, con maniglia blu
Full bore ball valve - threaded ends M/F, with blue handle
Kugelhahn mit vollem Durchgang - AG/IG, mit blauem Hebelgriff
Vanne à boisseau sphérique à passage intégral - fixations M/F, avec poignée bleu
Полнопроходной шаровой кран - Соединения Н/В, с голубой ручкой



Cod./Code	DN	Ø	□/田	€
104602209	1/4"	10	10/120	3,76
104603209	3/8"	10	10/120	4,53
104605209	1/2"	15	12/72	7,49
104607209	3/4"	20	15/60	10,27
104610209	1"	25	10/40	16,75
104612209	1"1/4	32	6/24	25,80
104615209	1"1/2	40	4/16	38,93
104620209	2"	50	2/8	58,48

IVR 46 LN



Valvola a sfera a passaggio totale - attacchi M/F, con maniglia nera
Full bore ball valve - threaded ends M/F, with black handle
Kugelhahn mit vollem Durchgang - AG/IG, mit schwarzem Hebelgriff
Vanne à boisseau sphérique à passage intégral - fixations M/F, avec poignée noire
Полнопроходной шаровой кран - Соединения Н/В, с чёрной ручкой



Cod./Code	DN	Ø	□/田	€
104602220	1/4"	10	10/120	3,76
104603220	3/8"	10	10/120	4,53
104605220	1/2"	15	12/72	7,49
104607220	3/4"	20	15/60	10,27
104610220	1"	25	10/40	16,75
104612220	1"1/4	32	6/24	25,80
104615220	1"1/2	40	4/16	38,93
104620220	2"	50	2/8	58,48

IVR 46/A



Valvola a sfera a passaggio totale - attacchi M/F, con farfalla rossa
Full bore ball valve - threaded ends M/F, with red butterfly handle
Kugelhahn mit vollem Durchgang - AG/IG, mit rotem Flügelgriff
Vanne à boisseau sphérique à passage intégral - fixations M/F, avec papillon rouge
Полнопроходной шаровой кран - Соединения Н/В, с красной ручкой "бабочка"

Cod./Code	DN	Ø	□/田	€
104602002	1/4"	10	10/120	3,68
104603002	3/8"	10	10/120	4,45
104605002	1/2"	15	12/72	7,40
104607002	3/4"	20	15/60	10,17
104610002	1"	25	10/40	16,47



IVR 46/A FB



Valvola a sfera a passaggio totale - attacchi M/F, con farfalla blu
Full bore ball valve - threaded ends M/F, with blue butterfly handle
Kugelhahn mit vollem Durchgang - AG/IG, mit blauem Flügelgriff
Vanne à boisseau sphérique à passage intégral - fixations M/F, avec papillon bleu
Полнопроходной шаровой кран - Соединения Н/В, с голубой ручкой "бабочка"



Cod./Code	DN	Ø	□/田	€
104602211	1/4"	10	10/120	3,68
104603211	3/8"	10	10/120	4,45
104605211	1/2"	15	12/72	7,40
104607211	3/4"	20	15/60	10,17
104610211	1"	25	10/40	16,47



IVR 46/A FN



Valvola a sfera a passaggio totale - attacchi M/F, con farfalla nera
Full bore ball valve - threaded ends M/F, with black butterfly handle
Kugelhahn mit vollem Durchgang - AG/IG, mit schwarzem Flügelgriff
Vanne à boisseau sphérique à passage intégral - fixations M/F, avec papillon noire
Полнопроходной шаровой кран - Соединения Н/В, с чёрной ручкой "бабочка"



Cod./Code	DN	Ø	□/田	€
104602221	1/4"	10	10/120	3,68
104603221	3/8"	10	10/120	4,45
104605221	1/2"	15	12/72	7,40
104607221	3/4"	20	15/60	10,17
104610221	1"	25	10/40	16,47



IVR 47



Valvola a sfera a passaggio totale - attacchi M/M, con maniglia rossa
Full bore ball valve - threaded ends M/M, with red handle
Kugelhahn mit vollem Durchgang - AG/AG, mit rotem Hebelgriff
Vanne à boisseau sphérique à passage intégral - fixations M/M, avec poignée rouge
Полнопроходной шаровой кран - Соединения Н/Н, с красной ручкой



Cod./Code	DN	Ø	□/田	€
195702007	1/4" ISO 228	10	10/120	3,98
195703007	3/8" ISO 228	10	10/120	3,96
104705006	1/2"	15	12/72	7,65
104707006	3/4"	20	10/40	10,11
104710006	1"	25	10/40	17,19

VERIFICARE
CODICE

IVR 47 LB



Valvola a sfera a passaggio totale - attacchi M/M, con maniglia blu
Full bore ball valve - threaded ends M/M, with blue handle
Kugelhahn mit vollem Durchgang - AG/AG, mit blauem Hebelgriff
Vanne à boisseau sphérique à passage intégral - fixations M/M, avec poignée bleu
Полнопроходной шаровой кран - Соединения Н/Н, с голубой ручкой



Cod./Code	DN	Ø	□/田	€
195702209	1/4" ISO 228	10	10/120	3,98
195703209	3/8" ISO 228	10	10/120	3,96
104705209	1/2"	15	12/72	7,65
104707209	3/4"	20	10/40	10,11
104710209	1"	25	10/40	17,19



IVR 47 LN



Valvola a sfera a passaggio totale - attacchi M/M, con maniglia nera
Full bore ball valve - threaded ends M/M, with black handle
Kugelhahn mit vollem Durchgang - AG/AG, mit schwarzem Hebelgriff
Vanne à boisseau sphérique à passage intégral - fixations M/M, avec poignée noire
Полнопроходной шаровой кран - Соединения Н/Н, с чёрной ручкой



Cod./Code	DN	Ø	□/田	€
195702219	1/4" ISO 228	10	10/120	3,98
195703219	3/8" ISO 228	10	10/120	3,96
104705220	1/2"	15	12/72	7,65
104707220	3/4"	20	10/40	10,11
104710220	1"	25	10/40	17,19



IVR 47/A



Valvola a sfera a passaggio totale - attacchi M/M, con farfalla rossa
Full bore ball valve - threaded ends M/M, with red butterfly handle
Kugelhahn mit vollem Durchgang - AG/AG, mit rotem Flügelgriff
Vanne à boisseau sphérique à passage intégral - fixations M/M, avec papillon rouge
Полнопроходной шаровой кран - Соединения Н/Н, с красной ручкой "бабочка"



Cod./Code	DN	Ø	□/田	€
195702008	1/4" ISO 228	10	10/120	3,90
195703008	3/8" ISO 228	10	10/120	3,89
104705002	1/2"	15	12/72	7,43
104707002	3/4"	20	10/60	9,99
104710002	1"	25	10/40	16,96

IVR 47/A FB



Valvola a sfera a passaggio totale - attacchi M/M, con farfalla blu
Full bore ball valve - threaded ends M/M, with blue butterfly handle
Kugelhahn mit vollem Durchgang - AG/AG, mit blauem Flügelgriff
Vanne à boisseau sphérique à passage intégral - fixations M/M, avec papillon bleu
Полнопроходной шаровой кран - Соединения Н/Н, с голубой ручкой "бабочка"



Cod./Code	DN	Ø	□/田	€
195702211	1/4" ISO 228	10	10/120	3,90
195703211	3/8" ISO 228	10	10/120	3,89
104705211	1/2"	15	12/72	7,43
104707211	3/4"	20	10/60	9,99
104710211	1"	25	10/40	16,96

IVR 47/A FN



Valvola a sfera a passaggio totale - attacchi M/M, con farfalla nera
Full bore ball valve - threaded ends M/M, with black butterfly handle
Kugelhahn mit vollem Durchgang - AG/AG, mit schwarzem Flügelgriff
Vanne à boisseau sphérique à passage intégral - fixations M/M, avec papillon noire
Полнопроходной шаровой кран - Соединения Н/Н, с чёрной ручкой "бабочка"



Cod./Code	DN	Ø	□/田	€
195702335	1/4" ISO 228	10	10/120	3,90
195703335	3/8" ISO 228	10	10/120	3,89
104705221	1/2"	15	12/72	7,43
104707221	3/4"	20	10/60	9,99
104710221	1"	25	10/40	16,96

IVR 45 LD



Valvola a sfera a passaggio totale - attacchi F/F - con maniglia lucchettabile
Full bore ball valve - threaded ends F/F - with lockable handle
Kugelhahn mit vollem Durchgang - IG/IG- mit verriegelbarem Hebel
Vanne à boisseau sphérique à passage intégral - fixations F/F - avec poignée cadenassable
Полнопроходной шаровой кран - Соединения В/В - с запираемой ручкой

Cod./Code	DN	Ø	□/⊕	€
104502750	1/4"	10	10/120	6,05
104503750	3/8"	10	10/120	5,64
104505750	1/2"	15	12/72	8,84
104507750	3/4"	20	15/60	11,48
104510750	1"	25	10/40	17,95
104512750	1"1/4	32	6/24	25,49
104515750	1"1/2	40	4/16	39,29
104520750	2"	50	2/8	58,90



NOTA: Disponibile anche, con maniglia blu
NOTE: Available, with blue handle
ANMERKUNG: Erhältlich auch mit blauem Griff
NOTE: Disponible, avec poignée bleu
ПРИМЕЧАНИЕ: Доступен также с голубой ручкой

IVR 46 LD



Valvola a sfera a passaggio totale - attacchi M/F - con maniglia lucchettabile
Full bore ball valve - threaded ends M/F - with lockable handle
Kugelhahn mit vollem Durchgang - AG/IG - mit verriegelbarem Hebel
Vanne à boisseau sphérique à passage intégral - fixations M/F - avec poignée cadenassable
Полнопроходной шаровой кран - Соединения Н/В - с запираемой ручкой

Cod./Code	DN	Ø	□/⊕	€
104602750	1/4"	10	10/120	5,73
104603750	3/8"	10	10/120	6,02
104605750	1/2"	15	12/72	9,15
104607750	3/4"	20	15/60	11,94
104610750	1"	25	10/40	18,75
104612750	1"1/4	32	6/24	27,83
104615750	1"1/2	40	4/16	42,48
104620750	2"	50	2/8	61,84



NOTA: Disponibile anche, con maniglia blu
NOTE: Available, with blue handle
ANMERKUNG: Erhältlich auch mit blauem Griff
NOTE: Disponible, avec poignée bleu
ПРИМЕЧАНИЕ: Доступен также с голубой ручкой

IVR 52 SFERA INOX



Valvola a sfera a passaggio totale - sfera acciaio inox AISI 304 - attacchi F/F
Full bore ball valve - ball in s.s. AISI 304 - stainless steel ball - threaded ends F/F
Kugelhahn mit vollem Durchgang - Kugel aus rostfreiem Edelstahl AISI 304 - IG/IG
Vanne à boisseau sphérique à passage intégral - Sphère acier inox AISI 304 - fixations F/F
Полнопроходной шаровой кран - шар из нержавеющей стали AISI 304 - соединения В/В

Cod./Code	DN	Ø	□/⊕	€
105202001	1/4"	10	10/120	5,36
105203001	3/8"	10	10/120	4,97
105205001	1/2"	15	12/72	7,70
105207001	3/4"	20	15/60	10,47
105210001	1"	25	10/40	16,55
105212001	1"1/4	32	6/24	25,73
105215001	1"1/2	40	4/16	39,77
105220001	2"	50	2/8	66,30

EAC

IVR 52/A SFERA INOX



Valvola a sfera a passaggio totale - sfera acciaio inox AISI 304 - attacchi F/F
Full bore ball valve - AISI 304 stainless steel ball - threaded ends F/F
Kugelhahn mit vollem Durchgang - Kugel aus rostfreiem Edelstahl AISI 304 - IG/IG
Vanne à boisseau sphérique à passage intégral - Sphère acier inox AISI 304 - fixations F/F
Полнопроходной шаровой кран - шар из нержавеющей стали AISI 304 - соединения В/В

Cod./Code	DN	Ø	□/⊕	€
105202002	1/4"	10	10/120	5,29
105203002	3/8"	10	10/120	4,89
105205002	1/2"	15	12/72	7,60
105207002	3/4"	20	15/60	10,38
105210002	1"	25	10/40	16,30

EAC



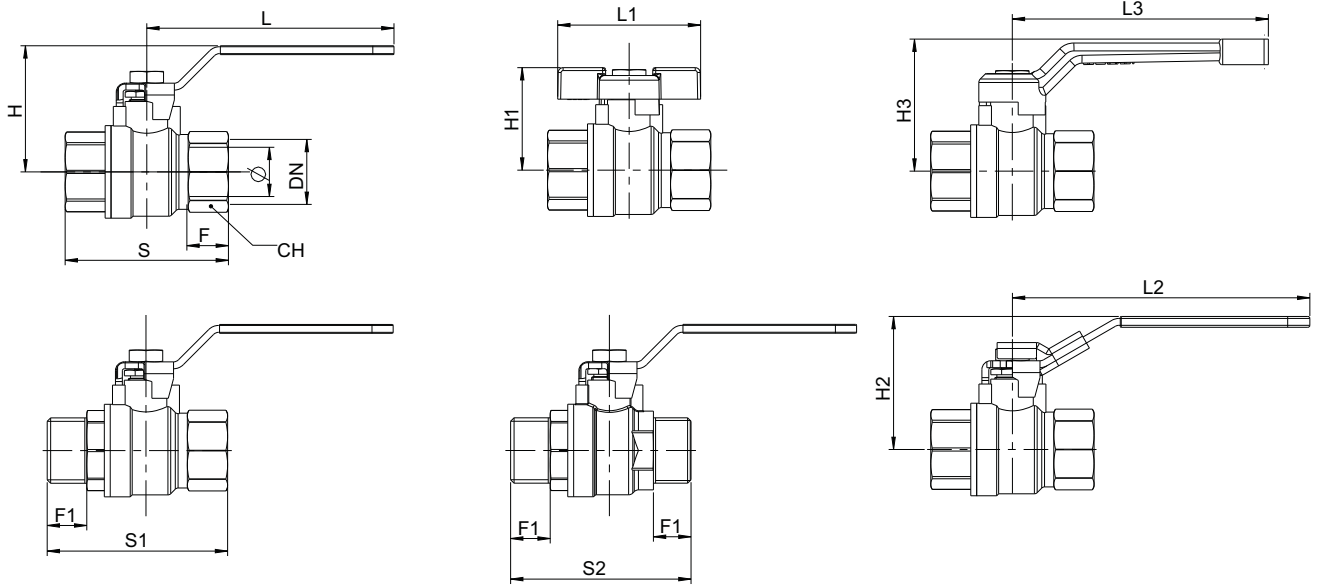

EXPORT

DIMENSIONI / DIMENSIONS

DN	Ø	S	S1	S2	L	L1	L2	L3	H	H1	H2	H3	F	F1	CH
1/4"	10	45	42	52	80	50	95	85	40	33	43	44	12	10	21
3/8"	10	45	54	54	80	50	95	85	40	33	44	44	12	12	21
1/2"	15	63	70	68	90	61	120	110	52	39	56	52	17	15	26
3/4"	20	71	80	77	90	61	120	110	55	43	60	55	19,5	16	31
1"	25	83	92	92	125	72	150	130	64	52	68	67	21	19	38
1"1/4	32	92	102		125		150	130	69	57	73	72	22	20,5	48
1"1/2	40	104	117		140		160	160	78		87	88	23,5	21,5	55
2"	50	124	137		140		160	160	85		94	95	28	24,5	68
2"1/2	60	140			250			160	131				28		85
3"	74	159			250			160	140				30,5		99
4"	94	196			250			160	154				38		125

EXPORT

ACCESSORI / RICAMBI - ACCESSORIES / SPARE PARTS

1/4"	700702001 € 0,95	700101001 € 0,61	700105001 € 0,61	700102001 € 0,60	703001501 € 0,51	703005001 € 0,56	703002001 € 0,56	750106001 € 0,43	125603440 € 1,94	125603600 € 1,94	109702030 € 5,30
3/8"	700702001 € 0,95	700101001 € 0,61	700105001 € 0,61	700102001 € 0,60	703001501 € 0,51	703005001 € 0,56	703002001 € 0,56	750106001 € 0,43	125603440 € 1,94	125603600 € 1,94	109702030 € 5,30
1/2"	700712001 € 1,24	700111001 € 0,78	700115001 € 0,78	700112001 € 0,78	703011501 € 0,70	703015001 € 0,70	703012001 € 0,70	750108001 € 0,44	125605440 € 2,37	125605600 € 2,37	109705030 € 6,76
3/4"	700712001 € 1,24	700111001 € 0,78	700115001 € 0,78	700112001 € 0,78	703011501 € 0,70	703015001 € 0,70	703012001 € 0,70	750108001 € 0,44	125605440 € 2,37	125605600 € 2,37	109705030 € 6,76
1"	700722001 € 2,66	700121001 € 1,05	700125001 € 1,05	700122001 € 1,05	703021501 € 0,83	703025001 € 0,83	703022001 € 0,83	750110001 € 0,48	125610440 € 3,01	125610600 € 3,01	109710030 € 9,06
1"1/4	700722001 € 2,66	700121001 € 1,05	700125001 € 1,05	700122001 € 1,05				750110001 € 0,48	125610440 € 3,01	125610600 € 3,01	109710030 € 9,06
1"1/2	700732001 € 3,53	700131001 € 1,47	700135001 € 1,47	700132001 € 1,47				750114001 € 0,55	125615440 € 5,18	125615600 € 5,18	109715030 € 12,04
2"	700732001 € 3,53	700131001 € 1,47	700135001 € 1,47	700132001 € 1,47				750114001 € 0,55	125615440 € 5,18	125615600 € 5,18	109715030 € 12,04
2"1/2	701052001 € 7,52	700151001 € 5,47	700155001 € 5,47	700152001 € 5,47				750118001 € 0,74			109725010 € 24,87
3"	701052001 € 7,52	700151001 € 5,47	700155001 € 5,47	700152001 € 5,47				750118001 € 0,74			109725010 € 24,87
4"	701052001 € 7,52	700151001 € 5,47	700155001 € 5,47	700152001 € 5,47				750118001 € 0,74			109725010 € 24,87

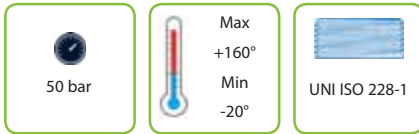

IVR EVERLAST PLUS

IVR 954 PLUS



- (*) Maniglia imbutita in acciaio
- (*) Steel drawn handle
- (*) Tiefgezogener Griff aus Stahl
- (*) Poignée emboutie en acier
- (*) Штампованная стальная ручка



Valvola a sfera a passaggio totale - attacchi F/F
Full bore ball valve - threaded ends F/F
Kugelhahn mit vollem Durchgang - IG/IG
Vanne à boisseau sphérique à passage intégral - fixations F/F
Полнопроходной шаровой кран - Соединения В/В

Cod./Code	DN	Ø	□/田	€
195402024	1/4"	10	10/120	4,28
195403024	3/8"	10	10/120	4,48
195405024	1/2"	15	20/120	5,78
195407024	3/4"	20	20/80	8,17
195410024	1"	25	12/48	13,26
195412024	1 1/4"	32	8/32	20,33
195415024	1 1/2"	40	6/24	30,98
195420024	2"	50	4/16	46,79
195425024	2 1/2"	61	8	106,78 (*)
195430024	3"	74	6	146,68 (*)
195440024	4"	95	2	224,92 (*)

IVR 956 PLUS



Valvola a sfera a passaggio totale - attacchi M/F
Full bore ball valve - threaded ends M/F
Kugelhahn mit vollem Durchgang - AG/IG
Vanne à boisseau sphérique à passage intégral - fixations M/F
Полнопроходной шаровой кран - Соединения Н/В

Cod./Code	DN	Ø	□/田	€
195602334	1/4"	10	10/120	4,24
195603334	3/8"	10	10/120	4,29
195605334	1/2"	15	20/120	5,77
195607334	3/4"	20	20/80	8,09
195610334	1"	25	12/48	13,26
195612334	1 1/4"	32	8/32	20,27
195615334	1 1/2"	40	6/24	30,19
195620334	2"	50	4/16	43,56

IVR 957 PLUS



Valvola a sfera a passaggio totale - attacchi M/M
Full bore ball valve - threaded ends M/M
Kugelhahn mit vollem Durchgang - AG/AG
Vanne à boisseau sphérique à passage intégral - fixations M/M
Полнопроходной шаровой кран - Соединения Н/Н

Cod./Code	DN	Ø	□/田	€
195702334	1/4"	10	10/120	4,49
195703334	3/8"	10	10/120	4,46
195705334	1/2"	15	10/120	6,25
195707334	3/4"	20	20/80	8,44
195710334	1"	25	10/40	13,97
195712334	1 1/4"	32	8/32	22,25
195715334	1 1/2"	40	6/24	31,90
195720334	2"	50	4/16	45,41

IVR EVERLAST

50 bar

Max
+160°
Min
-20°

UNI ISO 228-1

IVR 954



Valvola a sfera a passaggio totale - attacchi F/F, con maniglia rossa
Full bore ball valve - threaded ends F/F, with red handle
Kugelhahn mit vollem Durchgang - IG/IG, mit rotem Hebelgriff
Vanne à boisseau sphérique à passage intégral - fixations F/F, avec poignée rouge
Полнопроходной шаровой кран - Соединения В/В, с красной ручкой

Cod./Code	DN	Ø	□/田	€
195402007	1/4"	10	10/120	3,78
195403007	3/8"	10	10/120	3,99
195405007	1/2"	15	20/120	5,34
195407007	3/4"	20	20/80	7,74
195410007	1"	25	12/48	12,76
195412007	1*1/4	32	8/32	20,06
195415007	1*1/2	40	6/24	29,13
195420007	2"	50	4/16	44,94
195425007	2*1/2	61	8	99,70
195430007	3"	74	6	139,59
195440007	4"	95	2	222,26



IVR 954 LB



Valvola a sfera a passaggio totale - attacchi F/F, con maniglia blu
Full bore ball valve - threaded ends F/F, with blue handle
Kugelhahn mit vollem Durchgang - IG/IG, mit blauem Hebelgriff
Vanne à boisseau sphérique à passage intégral - fixations F/F, avec poignée bleu
Полнопроходной шаровой кран - Соединения В/В, с голубой ручкой

Cod./Code	DN	Ø	□/田	€
195402209	1/4"	10	10/120	3,78
195403209	3/8"	10	10/120	3,99
195405209	1/2"	15	20/120	5,34
195407209	3/4"	20	20/80	7,74
195410209	1"	25	12/48	12,76
195412209	1*1/4	32	8/32	20,06
195415209	1*1/2	40	6/24	29,13
195420209	2"	50	4/16	44,94
195425209	2*1/2	61	8	99,70
195430209	3"	74	6	139,59
195440209	4"	95	2	222,26

SU RICHIESTA
ON DEMAND



IVR 954 LN



Valvola a sfera a passaggio totale - attacchi F/F, con maniglia nera
Full bore ball valve - threaded ends F/F, with black handle
Kugelhahn mit vollem Durchgang - IG/IG, mit schwarzem Hebelgriff
Vanne à boisseau sphérique à passage intégral - fixations F/F, avec poignée noire
Полнопроходной шаровой кран - Соединения В/В, с чёрной ручкой

Cod./Code	DN	Ø	□/田	€
195402219	1/4"	10	10/120	3,78
195403219	3/8"	10	10/120	3,99
195405219	1/2"	15	20/120	5,34
195407219	3/4"	20	20/80	7,74
195410219	1"	25	12/48	12,76
195412219	1*1/4	32	8/32	20,06
195415219	1*1/2	40	6/24	29,13
195420219	2"	50	4/16	44,94
195425219	2*1/2	61	8	99,70
195430219	3"	74	6	139,59
195440219	4"	95	2	222,26

SU RICHIESTA
ON DEMAND



IVR 954/A



Valvola a sfera a passaggio totale - attacchi F/F, con farfalla rossa
Full bore ball valve - threaded ends F/F, with red butterfly handle
Kugelhahn mit vollem Durchgang - IG/IG, mit rotem Flügelgriff
Vanne à boisseau sphérique à passage intégral - fixations F/F, avec papillon rouge
Полнопроходной шаровой кран - Соединения В/В, с красной ручкой "бабочка"

Cod./Code	DN	Ø	□/田	€
195402008	1/4"	10	10/120	3,71
195403008	3/8"	10	10/120	3,91
195405008	1/2"	15	20/120	5,23
195407008	3/4"	20	20/80	7,63
195410008	1"	25	12/48	12,59
195412008	1"1/4	32	8/32	19,89



IVR 954/A FB



Valvola a sfera a passaggio totale - attacchi F/F, con farfalla blu
Full bore ball valve - threaded ends F/F, with blue butterfly handle
Kugelhahn mit vollem Durchgang - IG/IG, mit blauem Flügelgriff
Vanne à boisseau sphérique à passage intégral - fixations F/F, avec papillon bleu
Полнопроходной шаровой кран - Соединения В/В, с голубой ручкой "бабочка"

Cod./Code	DN	Ø	□/田	€
195402211	1/4"	10	10/120	3,71
195403211	3/8"	10	10/120	3,91
195405211	1/2"	15	20/120	5,23
195407211	3/4"	20	20/80	7,63
195410211	1"	25	12/48	12,59
195412211	1"1/4	32	8/32	19,89



IVR 954/A FN



Valvola a sfera a passaggio totale - attacchi F/F, con farfalla nera
Full bore ball valve - threaded ends F/F, with black butterfly handle
Kugelhahn mit vollem Durchgang - IG/IG, mit schwarzem Flügelgriff
Vanne à boisseau sphérique à passage intégral - fixations F/F, avec papillon noire
Полнопроходной шаровой кран - Соединения В/В, с чёрной ручкой "бабочка"

Cod./Code	DN	Ø	□/田	€
195402335	1/4"	10	10/120	3,71
195403335	3/8"	10	10/120	3,91
195405335	1/2"	15	20/120	5,23
195407335	3/4"	20	20/80	7,63
195410335	1"	25	12/48	12,59
195412335	1"1/4	32	8/32	19,89



IVR 956



Valvola a sfera a passaggio totale - attacchi M/F, con maniglia rossa
Full bore ball valve - threaded ends M/F, with red handle
Kugelhahn mit vollem Durchgang - AG/IG, mit rotem Hebelgriff
Vanne à boisseau sphérique à passage intégral - fixations M/F, avec poignée rouge
Полнопроходной шаровой кран - Соединения Н/В, с красной ручкой



Cod./Code	DN	Ø	□/田	€
195602007	1/4"	10	10/120	3,74
195603007	3/8"	10	10/120	3,80
195605007	1/2"	15	20/120	5,34
195607007	3/4"	20	20/80	7,66
195610007	1"	25	12/48	12,87
195612007	1*1/4	32	8/32	20,01
195615007	1*1/2	40	6/24	28,34
195620007	2"	50	4/16	43,56

IVR 956 LB

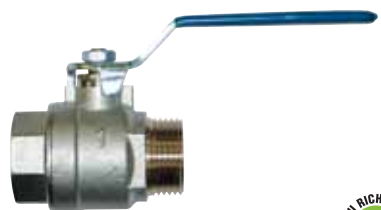

Valvola a sfera a passaggio totale - attacchi M/F, con maniglia blu
Full bore ball valve - threaded ends M/F, with blue handle
Kugelhahn mit vollem Durchgang - AG/IG, mit blauem Hebelgriff
Vanne à boisseau sphérique à passage intégral - fixations M/F, avec poignée bleu
Полнопроходной шаровой кран - Соединения Н/В, с голубой ручкой



Cod./Code	DN	Ø	□/田	€
195602209	1/4"	10	10/120	3,74
195603209	3/8"	10	10/120	3,80
195605209	1/2"	15	20/120	5,34
195607209	3/4"	20	20/80	7,66
195610209	1"	25	12/48	12,87
195612209	1*1/4	32	8/32	20,01
195615209	1*1/2	40	6/24	28,34
195620209	2"	50	4/16	43,56

IVR 956 LN



Valvola a sfera a passaggio totale - attacchi M/F, con maniglia nera
Full bore ball valve - threaded ends M/F, with black handle
Kugelhahn mit vollem Durchgang - AG/IG, mit schwarzem Hebelgriff
Vanne à boisseau sphérique à passage intégral - fixations M/F, avec poignée noire
Полнопроходной шаровой кран - Соединения Н/В, с чёрной ручкой



Cod./Code	DN	Ø	□/田	€
195602219	1/4"	10	10/120	3,74
195603219	3/8"	10	10/120	3,80
195605219	1/2"	15	20/120	5,34
195607219	3/4"	20	20/80	7,66
195610219	1"	25	12/48	12,87
195612219	1*1/4	32	8/32	20,01
195615219	1*1/2	40	6/24	28,34
195620219	2"	50	4/16	43,56

IVR 956/A



Valvola a sfera a passaggio totale - attacchi M/F, con farfalla rossa
Full bore ball valve - threaded ends M/F, with red butterfly handle
Kugelhahn mit vollem Durchgang - AG/IG, mit rotem Flügelgriff
Vanne à boisseau sphérique à passage intégral - fixations M/F, avec papillon rouge
Полнопроходной шаровой кран - Соединения Н/В, с красной ручкой "бабочка"

Cod./Code	DN	Ø	□/田	€
195602008	1/4"	10	10/120	3,67
195603008	3/8"	10	10/120	3,72
195605008	1/2"	15	20/120	5,23
195607008	3/4"	20	20/80	7,54
195610008	1"	25	12/48	12,71
195612008	1 1/4"	32	8/32	19,84



IVR 956/A FB



Valvola a sfera a passaggio totale - attacchi M/F, con farfalla blu
Full bore ball valve - threaded ends M/F, with blue butterfly handle
Kugelhahn mit vollem Durchgang - AG/IG, mit blauem Flügelgriff
Vanne à boisseau sphérique à passage intégral - fixations M/F, avec papillon bleu
Полнопроходной шаровой кран - Соединения Н/В с голубой ручкой "бабочка"



Cod./Code	DN	Ø	□/田	€
195602211	1/4"	10	10/120	3,67
195603211	3/8"	10	10/120	3,72
195605211	1/2"	15	20/120	5,23
195607211	3/4"	20	20/80	7,54
195610211	1"	25	12/48	12,71
195612211	1 1/4"	32	8/32	19,84



IVR 956/A FN



Valvola a sfera a passaggio totale - attacchi M/F, con farfalla nera
Full bore ball valve - threaded ends M/F, with black butterfly handle
Kugelhahn mit vollem Durchgang - AG/IG, mit schwarzem Flügelgriff
Vanne à boisseau sphérique à passage intégral - fixations M/F, avec papillon noire
Полнопроходной шаровой кран - Соединения Н/В, с чёрной ручкой "бабочка"



Cod./Code	DN	Ø	□/田	€
195602335	1/4"	10	10/120	3,67
195603335	3/8"	10	10/120	3,72
195605335	1/2"	15	20/120	5,23
195607335	3/4"	20	20/80	7,54
195610335	1"	25	12/48	12,71
195612335	1 1/4"	32	8/32	19,84



IVR 957



Valvola a sfera a passaggio totale - attacchi M/M, con maniglia rossa
Full bore ball valve - threaded ends M/M, with red handle
Kugelhahn mit vollem Durchgang - AG/AG, mit rotem Hebelgriff
Vanne à boisseau sphérique à passage intégral - fixations M/M, avec poignée rouge
Полнопроходной шаровой кран - Соединения Н/Н, с красной ручкой



Cod./Code	DN	Ø	□/田	€
195702007	1/4"	10	10/120	3,98
195703007	3/8"	10	10/120	3,96
195705007	1/2"	15	20/120	5,82
195707007	3/4"	20	20/80	8,00
195710007	1"	25	10/40	13,48
195712007	1"1/4	32	8/32	21,99
195715007	1"1/2	40	6/24	30,05
195720007	2"	50	4/16	46,61

IVR 957 LB



Valvola a sfera a passaggio totale - attacchi M/M, con maniglia blu
Full bore ball valve - threaded ends M/M, with blue handle
Kugelhahn mit vollem Durchgang - AG/AG, mit blauem Hebelgriff
Vanne à boisseau sphérique à passage intégral - fixations M/M, avec poignée bleu
Полнопроходной шаровой кран - Соединения Н/Н, с голубой ручкой



Cod./Code	DN	Ø	□/田	€
195702209	1/4"	10	10/120	3,98
195703209	3/8"	10	10/120	3,96
195705209	1/2"	15	20/120	5,82
195707209	3/4"	20	20/80	8,00
195710209	1"	25	10/40	13,48
195712209	1"1/4	32	8/32	21,99
195715209	1"1/2	40	6/24	30,05
195720209	2"	50	4/16	46,61



IVR 957 LN



Valvola a sfera a passaggio totale - attacchi M/M, con maniglia nera
Full bore ball valve - threaded ends M/M, with black handle
Kugelhahn mit vollem Durchgang - AG/AG, mit schwarzem Hebelgriff
Vanne à boisseau sphérique à passage intégral - fixations M/M, avec poignée noire
Полнопроходной шаровой кран - Соединения Н/Н, с чёрной ручкой



Cod./Code	DN	Ø	□/田	€
195702219	1/4"	10	10/120	3,98
195703219	3/8"	10	10/120	3,96
195705219	1/2"	15	20/120	5,82
195707219	3/4"	20	20/80	8,00
195710219	1"	25	10/40	13,48
195712219	1"1/4	32	8/32	21,99
195715219	1"1/2	40	6/24	30,05
195720219	2"	50	4/16	46,61



IVR 957/A



Valvola a sfera a passaggio totale - attacchi M/M, con farfalla rossa

Full bore ball valve - threaded ends M/M, with red butterfly handle

Kugelhahn mit vollem Durchgang - AG/AG, mit rotem Flügelgriff

Vanne à boisseau sphérique à passage intégral - fixations M/M, avec papillon rouge

Полнопроходной шаровой кран - Соединения Н/Н, с красной ручкой "бабочка"

Cod./Code	DN	Ø	□/田	€
195702008	1/4"	10	10/120	3,90
195703008	3/8"	10	10/120	3,89
195705008	1/2"	15	10/120	5,70
195707008	3/4"	20	20/80	7,89
195710008	1"	25	10/40	13,32



IVR 957/A FB



Valvola a sfera a passaggio totale - attacchi M/M, con farfalla blu

Full bore ball valve - threaded ends M/M, with blue butterfly handle

Kugelhahn mit vollem Durchgang - AG/AG, mit blauem Flügelgriff

Vanne à boisseau sphérique à passage intégral - fixations M/M, avec papillon bleu

Полнопроходной шаровой кран - Соединения Н/Н, с голубой ручкой "бабочка"

Cod./Code	DN	Ø	□/田	€
195702211	1/4"	10	10/120	3,90
195703211	3/8"	10	10/120	3,89
195705211	1/2"	15	10/120	5,70
195707211	3/4"	20	20/80	7,89
195710211	1"	25	10/40	13,32



IVR 957/A FN



Valvola a sfera a passaggio totale - attacchi M/M, con farfalla nera

Full bore ball valve - threaded ends M/M, with black butterfly handle

Kugelhahn mit vollem Durchgang - AG/AG, mit schwarzem Flügelgriff

Vanne à boisseau sphérique à passage intégral - fixations M/M, avec papillon noire

Полнопроходной шаровой кран - Соединения Н/Н, с чёрной ручкой "бабочка"

Cod./Code	DN	Ø	□/田	€
195702335	1/4"	10	10/120	3,90
195703335	3/8"	10	10/120	3,89
195705335	1/2"	15	10/120	5,70
195707335	3/4"	20	20/80	7,89
195710335	1"	25	10/40	13,32



IVR 954 LD



Valvola a sfera a passaggio totale - attacchi F/F con maniglia lucchettabile
Full bore ball valve - threaded ends F/F - with lockable handle
Kugelhahn mit vollem Durchgang - IG/IG- mit verriegelbarem Hebel
Vanne à boisseau sphérique à passage intégral - fixations F/F - avec poignée cadenassable
Полнопроходной шаровой кран - Соединения В/В - с запираемой ручкой

Cod./Code	DN	Ø	□/田	€
195402750	1/4"	10	10/120	5,26
195403750	3/8"	10	10/120	5,47
195405750	1/2"	15	20/80	6,78
195407750	3/4"	20	20/80	9,15
195410750	1"	25	12/48	14,78
195412750	1"1/4	32	6/24	21,78
195415750	1"1/2	40	4/16	31,17
195420750	2"	50	2/8	47,12



NOTA: Disponibile anche, con maniglia blu
NOTE: Available, with blue handle
ANMERKUNG: Erhältlich auch mit blauem Griff
NOTE: Disponible, avec poignée bleu
ПРИМЕЧАНИЕ: Доступен также с голубой рукояткой

IVR 954/P

NEW



Valvola a sfera a passaggio totale - attacchi FF - con prolunga per coibentazione
Full bore ball valve - threaded ends F/F, with red handle - with isolation extension
Kugelhahn mit vollem Durchgang - IG/IG, mit rotem Hebelgriff - mit Isolierungsverlängerung
Vanne à boisseau sphérique à passage intégral - fixations F/F, avec poignée rouge - avec rallonge pour l'isolation
Полнопроходной шаровой кран - Соединения В/В, с красной ручкой - с удлинителем для изоляции

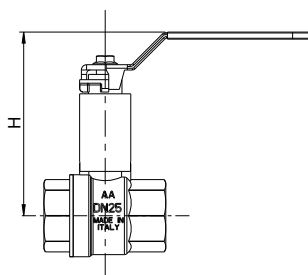

Cod./Code	DN	Ø	H	□/田	€
195405807	1/2"	15	87	15/60	12,25
195407807	3/4"	20	91	12/48	14,64
195410807	1"	25	104	12/48	21,31
195412807	1"1/4	32	109	6/24	28,28
195415807	1"1/2	40	127	4/16	40,36
195420807	2"	50	135	2/8	55,60



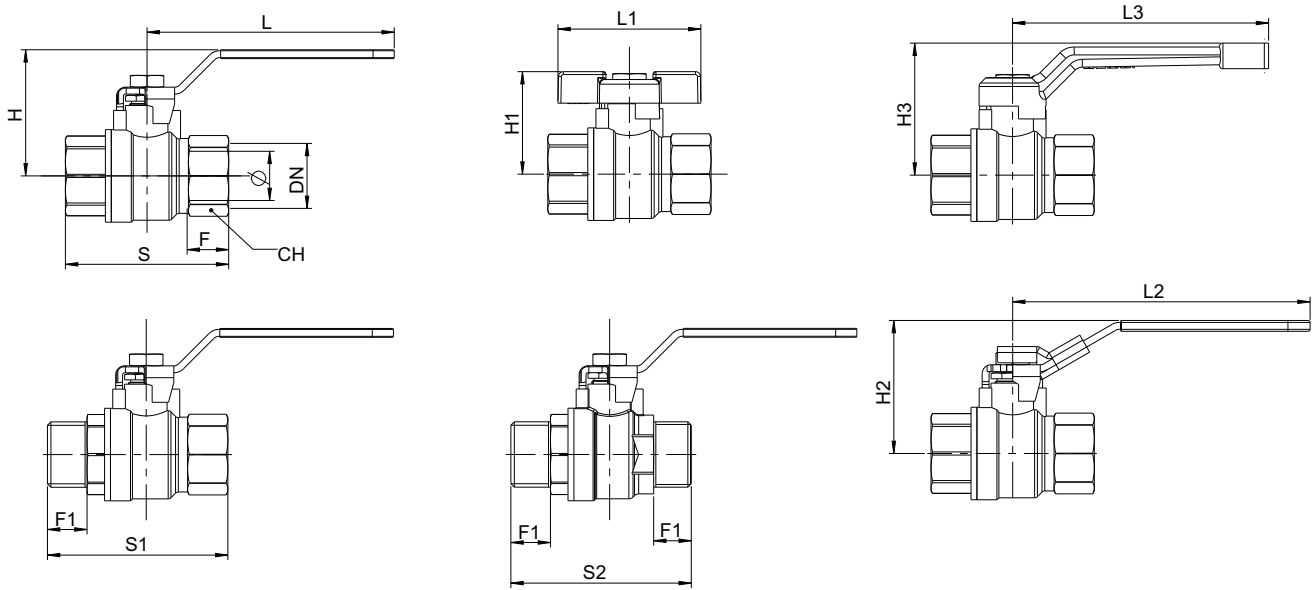

EVERLAST		DIMENSIONI / DIMENSIONS													
DN	Ø	S	S1	S2	L	L1	L2	L3	H	H1	H2	H3	F	F1	CH
1/4"	10	42	43,5	52	80	50	95	85	40	33	43	44	9,5	10	17
3/8"	10	44	45	52	80	50	95	85	40	33	43	44	10,5	10	20
1/2"	15	50	50	58	92	50	95	85	43	37	46	47	11	10,5	25
3/4"	20	57	58	66	92	50	95	85	47	40	46	51	13	13	31
1"	25	70	70	78	115	61	120	110	59	47	64	60	15	15	38
1 1/4"	32	80	81	91	115		120	110	64			64	17	17	47
1 1/2"	40	90	91	102	150		150	130	75			78	18	18	54
2"	50	107	107	118	150		150	130	82			85	20	20	66
2 1/2"	60	132			200				108				22		84
3"	74	151			250				117				26		96
4"	94	179			250				154				30		123

EVERLAST		ACCESSORI / RICAMBI - ACCESSORIES / SPARE PARTS													
1/4"	700702001 € 0,95	700101001 € 0,61	700105001 € 0,61	700102001 € 0,60	703001501 € 0,51	703005001 € 0,56	703002001 € 0,56	750106001 € 0,43	125603440 € 1,94	125603600 € 1,94	109702030 € 5,30				
3/8"	700702001 € 0,95	700101001 € 0,61	700105001 € 0,61	700102001 € 0,60	703001501 € 0,51	703005001 € 0,56	703002001 € 0,56	750106001 € 0,43	125603440 € 1,94	125603600 € 1,94	109702030 € 5,30				
1/2"	700702001 € 0,95	700411001 € 0,70	700415001 € 0,66	700412001 € 0,70	703001501 € 0,51	703005001 € 0,56	703002001 € 0,56	750106001 € 0,43	125603440 € 1,94	125603600 € 1,94	109702030 € 5,30				
3/4"	700702001 € 0,95	700411001 € 0,70	700415001 € 0,66	700412001 € 0,70	703001501 € 0,51	703005001 € 0,56	703002001 € 0,56	750106001 € 0,43	125603440 € 1,94	125603600 € 1,94	109702030 € 5,30				
1"	700712001 € 1,24	700421001 € 0,92	700425001 € 0,91	700422001 € 0,92	703011501 € 0,70	703015001 € 0,70	703012001 € 0,70	750108001 € 0,44	125605440 € 2,37	125605600 € 2,37	109705030 € 6,76				
1 1/4"	700712001 € 1,24	700421001 € 0,92	700425001 € 0,91	700422001 € 0,92				750108001 € 0,44	125605440 € 2,37	125605600 € 2,37	109705030 € 6,76				
1 1/2"	700722001 € 2,66	700431001 € 1,40	700435001 € 1,40	700432001 € 1,40				750110001 € 0,48	125610440 € 3,01	125610600 € 3,01	109710030 € 9,06				
2"	700722001 € 2,66	700431001 € 1,40	700435001 € 1,40	700432001 € 1,40				750110001 € 0,48	125610440 € 3,01	125610600 € 3,01	109710030 € 9,06				
2 1/2"		700441001 € 3,66	700445001 € 3,66	700442001 € 3,66				750116001 € 0,59			109720010 € 35,04				
3"		700441001 € 3,66	700445001 € 3,66	700442001 € 3,66				750116001 € 0,59			109720010 € 35,04				
4"		700151001 € 5,47	700155001 € 5,47	700152001 € 5,47				750118001 € 0,74			109725010 € 24,87				

IVR EVERWATER PLUS



40 bar

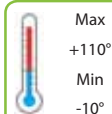

Max
+110°
Min
-10°



UNI EN 10226-1
(ISO 7-1 Rp)

IVR 935 PLUS

NEW



EAC

Valvola a sfera a passaggio standard - attacchi filettati F/F, con leva in alluminio nera
Standard bore ball valve - threaded ends F/F, with black handle in aluminium
Kugelhahn mit Standarddurchgang - IG/IG, mit schwarzem Hebelgriff aus Aluminium
Vanne à boisseau sphérique à passage normal - fixations F/F avec poignée noire en aluminium
Шаровой кран со стандартным проходом, соединения: резьба В/В, с черным алюминиевым рычагом

Cod./Code	DN	Ø	□/田	€
193505024	1/2"	14	15/90	5,79
193507024	3/4"	18	20/80	7,66
193510024	1"	23	12/48	13,26
193512024	1"1/4	30	8/32	19,50
193515024	1"1/2	37	4/16	29,74
193520024	2"	47	4/16	47,47

IVR 936 PLUS

NEW



EAC

Valvola a sfera a passaggio standard - attacchi filettati M/F, con leva in alluminio nera
Standard bore ball valve - threaded ends M/F, with black handle in aluminium
Kugelhahn mit Standarddurchgang - AG/IG, mit schwarzem Hebelgriff aus Aluminium
Vanne à boisseau sphérique à passage normal - fixations M/F avec poignée noire en aluminium
Шаровой кран со стандартным проходом, соединения: резьба Н/В, с черным алюминиевым рычагом

Cod./Code	DN	Ø	□/田	€
193605024	1/2"	14	15/90	6,17
193607024	3/4"	18	20/80	8,24
193610024	1"	23	12/48	14,21
193612024	1"1/4	30	8/32	21,66
193615024	1"1/2	37	4/16	31,06
193620024	2"	47	4/16	51,03

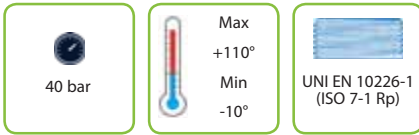

IVR EVERWATER

IVR 935



Valvola a sfera a passaggio standard - attacchi filettati F/F, con maniglia rossa
Standard bore ball valve - F/F threaded ends, with red handle
Kugelhahn mit normalem Durchgang - IG/IG, mit rotem Hebelgriff
Vanne à sphère à passage normal - fixations F/F, avec poignée rouge
Шаровой кран со стандартным проходом - соединения В/В, с красной ручкой



Cod./Code	DN	Ø	□/田	€
193505007	1/2"	14	12/72	5,36
193507007	3/4"	18	20/80	7,23
193510007	1"	23	12/48	12,77
193512007	1"1/4	30	8/32	19,23
193515007	1"1/2	37	4/16	28,73
193520007	2"	47	4/16	46,46

IVR 935 LB



Valvola a sfera a passaggio standard - attacchi filettati F/F, con maniglia blu
Standard bore ball valve - F/F threaded ends, with blue handle
Kugelhahn mit normalem Durchgang - IG/IG, mit blauem Hebelgriff
Vanne à sphère à passage normal - fixations F/F avec poignée bleu
Шаровой кран со стандартным проходом - соединения В/В, с голубой ручкой



Cod./Code	DN	Ø	□/田	€
193505209	1/2"	14	12/72	5,36
193507209	3/4"	18	20/80	7,23
193510209	1"	23	12/48	12,77
193512209	1"1/4	30	8/32	19,23
193515209	1"1/2	37	4/16	28,73
193520209	2"	47	4/16	46,46

IVR 935 LN



Valvola a sfera a passaggio standard - attacchi filettati F/F, con maniglia nera
Standard bore ball valve - F/F threaded ends, with black handle
Kugelhahn mit normalem Durchgang - IG/IG, mit schwarzem Hebelgriff
Vanne à sphère à passage normal - fixations F/F avec poignée noire
Шаровой кран со стандартным проходом - соединения В/В, с чёрной ручкой



Cod./Code	DN	Ø	□/田	€
193505220	1/2"	14	12/72	5,36
193507220	3/4"	18	20/80	7,23
193510220	1"	23	12/48	12,77
193512220	1"1/4	30	8/32	19,23
193515220	1"1/2	37	4/16	28,73
193520220	2"	47	4/16	46,46

IVR 935/A



Valvola a sfera a passaggio standard - attacchi filettati F/F, con farfalla rossa
Standard bore ball valve - F/F threaded ends, with red butterfly handle
Kugelhahn mit normalem Durchgang - IG/IG, mit rotem Flügelgriff
Vanne à sphère à passage normal - fixations F/F, avec papillon rouge
Шаровой кран со стандартным проходом - соединения В/В, с красной ручкой "бабочка"

EAC

Cod./Code	DN	Ø	□/田	€
193505008	1/2"	14	12/144	5,25
193507008	3/4"	18	20/80	7,12
193510008	1"	23	12/48	12,60

IVR 935/A FB



Valvola a sfera a passaggio standard - attacchi filettati F/F, con farfalla blu
Standard bore ball valve - F/F threaded ends, with blue butterfly handle
Kugelhahn mit normalem Durchgang - IG/IG, mit blauem Flügelgriff
Vanne à sphère à passage normal - fixations F/F, avec papillon bleu
Шаровой кран со стандартным проходом - соединения В/В, с голубой ручкой "бабочка"

NEW

EAC

SU RICHIESTA
ON DEMAND

Cod./Code	DN	Ø	□/田	€
193505211	1/2"	14	12/144	5,25
193507211	3/4"	18	20/80	7,12
193510211	1"	23	12/48	12,60

IVR 935/A FN



Valvola a sfera a passaggio standard - attacchi filettati F/F, con farfalla nera
Standard bore ball valve - F/F threaded ends, with black butterfly handle
Kugelhahn mit normalem Durchgang - IG/IG, mit schwarzem Flügelgriff
Vanne à sphère à passage normal - fixations F/F, avec papillon noire
Шаровой кран со стандартным проходом - соединения В/В, с чёрной ручкой "бабочка"

NEW

EAC

SU RICHIESTA
ON DEMAND

Cod./Code	DN	Ø	□/田	€
193505221	1/2"	14	12/144	5,25
193507221	3/4"	18	20/80	7,12
193510221	1"	23	12/48	12,60

IVR 936 EVERWATER



ERC

Valvola a sfera a passaggio standard - attacchi filettati M/F, con maniglia rossa
Standard bore ball valve - M/F threaded ends, with red handle
Kugelhahn mit normalem Durchgang - AG/IG, mit rotem Hebelgriff
Vanne à sphère à passage normal - fixations M/F, avec poignée rouge
Шаровой кран со стандартным проходом - соединения Н/В, с красной ручкой

Cod./Code	DN	Ø	□/田	€
193605007	1/2"	14	12/72	5,74
193607007	3/4"	18	20/80	7,80
193610007	1"	23	12/48	13,72
193612007	1"1/4	30	6/24	21,44
193615007	1"1/2	37	4/16	30,02
193620007	2"	47	4/16	50,02

IVR 936 LB



ERC

SU RICHIESTA
ON DEMAND

Valvola a sfera a passaggio standard - attacchi filettati M/F, con maniglia blu
Standard bore ball valve - M/F threaded ends, with blue handle
Kugelhahn mit normalem Durchgang - AG/IG, mit blauem Hebelgriff
Vanne à sphère à passage normal - fixations M/F avec poignée bleu
Шаровой кран со стандартным проходом - соединения Н/В, с голубой ручкой

Cod./Code	DN	Ø	□/田	€
193605209	1/2"	14	12/72	5,74
193607209	3/4"	18	20/80	7,80
193610209	1"	23	12/48	13,72
193612209	1"1/4	30	6/24	21,44
193615209	1"1/2	37	4/16	30,02
193620209	2"	47	4/16	50,02



IVR 936 LN



ERC

SU RICHIESTA
ON DEMAND

Valvola a sfera a passaggio standard - attacchi filettati M/F, con maniglia nera
Standard bore ball valve - M/F threaded ends, with black handle
Kugelhahn mit normalem Durchgang - AG/IG, mit schwarzem Hebelgriff
Vanne à sphère à passage normal - fixations M/F avec poignée noire
Шаровой кран со стандартным проходом - соединения Н/В, с чёрной ручкой

Cod./Code	DN	Ø	□/田	€
193605220	1/2"	14	20/120	5,74
193607220	3/4"	18	20/80	7,80
193610220	1"	23	12/48	13,72
193612220	1"1/4	30	8/32	21,44
193615220	1"1/2	37	6/24	30,02
193620220	2"	47	4/16	50,02



IVR 936/A



Valvola a sfera a passaggio standard - attacchi filettati M/F, con farfalla rossa
Standard bore ball valve - M/F threaded ends, with red butterfly handle
Kugelhahn mit normalem Durchgang - AG/IG, mit rotem Flügelgriff
Vanne à sphère à passage normal - fixations M/F, avec papillon rouge
Шаровой кран со стандартным проходом - соединения Н/В, с красной ручкой "бабочка"

EAC

Cod./Code	DN	Ø	□/田	€
193605008	1/2"	14	12/72	5,63
193607008	3/4"	18	20/80	7,69
193610008	1"	23	12/48	13,55

IVR 936/A FB



Valvola a sfera a passaggio standard - attacchi filettati M/F, con farfalla blu
Standard bore ball valve - M/F threaded ends, with blue butterfly handle
Kugelhahn mit normalem Durchgang - AG/IG, mit blauem Flügelgriff
Vanne à sphère à passage normal - fixations M/F, avec papillon bleu
Шаровой кран со стандартным проходом - соединения Н/В, с голубой ручкой "бабочка"

NEW

EAC



Cod./Code	DN	Ø	□/田	€
193605211	1/2"	14	12/72	5,63
193607211	3/4"	18	20/80	7,69
193610211	1"	23	12/48	13,55

IVR 936/A FN



Valvola a sfera a passaggio standard - attacchi filettati M/F, con farfalla nera
Standard bore ball valve - M/F threaded ends, with black butterfly handle
Kugelhahn mit normalem Durchgang - AG/IG, mit schwarzem Flügelgriff
Vanne à sphère à passage normal - fixations M/F, avec papillon noire
Шаровой кран со стандартным проходом - соединения Н/В, с чёрной ручкой "бабочка"

NEW

EAC



Cod./Code	DN	Ø	□/田	€
193605221	1/2"	14	12/72	5,63
193607221	3/4"	18	20/80	7,69
193610221	1"	23	12/48	13,55

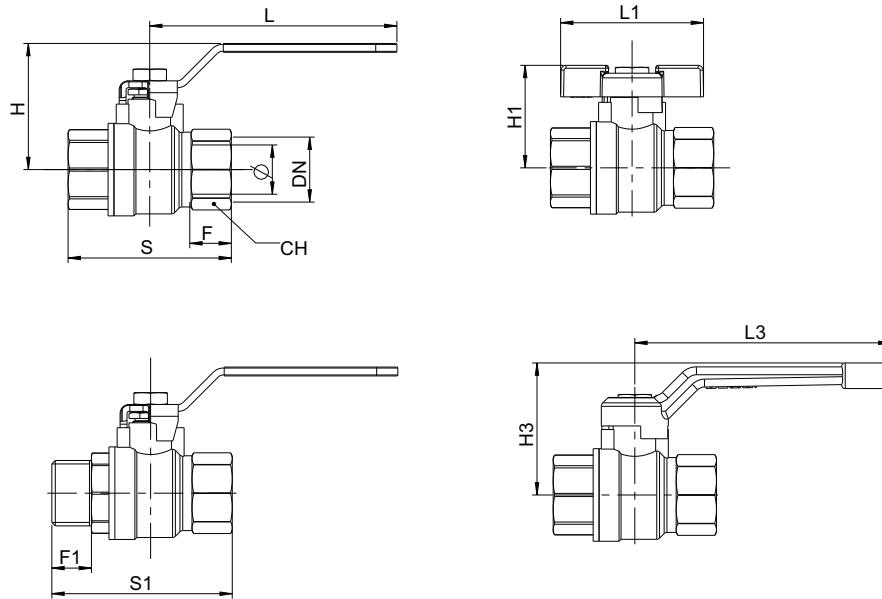

EVERWATER		DIMENSIONI / DIMENSIONS													
DN	Ø	S	S1	S2	L	L1	L2	L3	H	H1	H2	H3	F	F1	CH
1/2"	14	55	63,5		92	50		85	42,5	36		47	15	15	25
3/4"	18	61,5	69		92	50		85	45	39		49	16	16	31
1"	23	73	81,5		115	61		85	60	45		58	18	18	38
1"1/4	29	85,5	94,5		115			85	64			62	20,5	20,5	47
1"1/2	37	97	106		150			110	74,5			77	20,5	20,5	54
2"	47	117	129		150			110	81,5			84	25,5	25	66



EVERWATER		ACCESSORI / RICAMBI - ACCESSORIES / SPARE PARTS										
1/2"	700702001 € 0,95	700411001 € 0,70	700415001 € 0,66	700412001 € 0,70	703001501 € 0,51	703005001 € 0,56	703002001 € 0,56	750106001 € 0,43	125603440 € 1,94	125603600 € 1,94	109702030 € 5,30	
3/4"	700702001 € 0,95	700411001 € 0,70	700415001 € 0,66	700412001 € 0,70	703001501 € 0,51	703005001 € 0,56	703002001 € 0,56	750106001 € 0,43	125603440 € 1,94	125603600 € 1,94	109702030 € 5,30	
1"	700712001 € 1,24	700421001 € 0,92	700425001 € 0,91	700422001 € 0,92	703011501 € 0,70	703015001 € 0,70	703012001 € 0,70	750108001 € 0,44	125605440 € 2,37	125605600 € 2,37	109705030 € 6,76	
1"1/4	700712001 € 1,24	700421001 € 0,92	700425001 € 0,91	700422001 € 0,92				750108001 € 0,44	125605440 € 2,37	125605600 € 2,37	109705030 € 6,76	
1"1/2	700722001 € 2,66	700431001 € 1,40	700435001 € 1,40	700432001 € 1,40				750110001 € 0,48	125610440 € 3,01	125610600 € 3,01	109710030 € 9,06	
2"	700722001 € 2,66	700431001 € 1,40	700435001 € 1,40	700432001 € 1,40				750110001 € 0,48	125610440 € 3,01	125610600 € 3,01	109710030 € 9,06	

IVR EVERMID



40 bar



Max
+150°
Min
-10°



UNI ISO 228-1

IVR 918



Valvola a sfera a passaggio standard - attacchi F/F, con maniglia rossa
Standard bore ball valve - threaded ends F/F, with red handle
Kugelhahn mit Standarddurchgang - IG/IG, mit rotem Hebelgriff
Vanne à boisseau sphérique à passage normal - fixations F/F, avec poignée rouge
Шаровой кран со стандартным проходом - соединения В/В, с красной ручкой

Cod./Code	DN	Ø	□/田	€
191805007	1/2"	14	20/120	4,88
191807007	3/4"	18	20/80	6,59
191810007	1"	23	12/48	10,57
191812007	1*1/4	30	8/32	17,12
191815007	1*1/2	37	6/24	25,99
191820007	2"	47	4/16	40,33
191825007	2*1/2	50	12	66,42
191830007	3"	61	6	104,41
191840007	4"	74	6	154,07



IVR 918 LB



Valvola a sfera a passaggio standard - attacchi F/F, con maniglia blu
Standard bore ball valve - threaded ends F/F, with blue handle
Kugelhahn mit Standarddurchgang - IG/IG, mit blauem Hebelgriff
Vanne à boisseau sphérique à passage normal - fixations F/F, avec poignée bleu
Шаровой кран со стандартным проходом - соединения В/В, с голубой ручкой



Cod./Code	DN	Ø	□/田	€
191805209	1/2"	14	20/120	4,88
191807209	3/4"	18	20/80	6,59
191810209	1"	23	12/48	10,57
191812209	1*1/4	30	8/32	17,12
191815209	1*1/2	37	6/24	25,99
191820209	2"	47	4/16	40,33
191825209	2*1/2	50	12	66,42
191830209	3"	61	6	104,41
191840209	4"	74	6	154,07



NEW

IVR 918 LN



Valvola a sfera a passaggio standard - attacchi F/F, con maniglia nera
Standard bore ball valve - threaded ends F/F, with black handle
Kugelhahn mit Standarddurchgang - IG/IG, mit schwarzem Hebelgriff
Vanne à boisseau sphérique à passage normal - fixations F/F avec poignée noire
Шаровой кран со стандартным проходом - соединения В/В, с чёрной ручкой



Cod./Code	DN	Ø	□/田	€
191805219	1/2"	14	20/120	4,88
191807219	3/4"	18	20/80	6,59
191810219	1"	23	12/48	10,57
191812219	1*1/4	30	8/32	17,12
191815219	1*1/2	37	6/24	25,99
191820219	2"	47	4/16	40,33
191825219	2*1/2	50	12	66,42
191830219	3"	61	6	104,41
191840219	4"	74	6	154,07



NEW

IVR 918/A



Valvola a sfera a passaggio standard - attacchi F/F, con farfalla rossa
Standard bore ball valve - threaded ends F/F, with red butterfly handle
Kugelhahn mit Standarddurchgang - IG/IG, mit rotem Flügelgriff
Vanne à boisseau sphérique à passage normal - fixations F/F, avec papillon rouge
Шаровой кран со стандартным проходом - соединения В/В, с красной ручкой "бабочка"



Cod./Code	DN	Ø	□/田	€
191805008	1/2"	14	20/120	4,81
191807008	3/4"	18	20/80	6,52
191810008	1"	23	12/48	10,39

IVR 918/A FB



Valvola a sfera a passaggio standard - attacchi F/F, con farfalla blu
Standard bore ball valve - threaded ends F/F, with blue butterfly handle
Kugelhahn mit Standarddurchgang - IG/IG, mit blauem Flügelgriff
Vanne à boisseau sphérique à passage normal - fixations F/F, avec papillon bleu
Шаровой кран со стандартным проходом - соединения В/В, с голубой ручкой "бабочка"



Cod./Code	DN	Ø	□/田	€
191805211	1/2"	14	20/120	4,81
191807211	3/4"	18	20/80	6,52
191810211	1"	23	12/48	10,39

IVR 918/A FN



Valvola a sfera a passaggio standard - attacchi F/F, con farfalla nera
Standard bore ball valve - threaded ends F/F, with black butterfly handle
Kugelhahn mit Standarddurchgang - IG/IG, mit schwarzem Flügelgriff
Vanne à boisseau sphérique à passage normal - fixations F/F, avec papillon noire
Шаровой кран со стандартным проходом - соединения В/В, с чёрной ручкой "бабочка"



Cod./Code	DN	Ø	□/田	€
191805335	1/2"	14	20/120	4,81
191807335	3/4"	18	20/80	6,52
191810335	1"	23	12/48	10,39

IVR 919



Valvola a sfera a passaggio standard - attacchi M/F, con maniglia rossa
Standard bore ball valve - threaded ends M/F, with red handle
Kugelhahn mit Standarddurchgang - AG/IG, mit rotem Hebelgriff
Vanne à boisseau sphérique à passage normal - fixations M/F, avec poignée rouge
Шаровой кран со стандартным проходом - соединения Н/В, с красной ручкой

Cod./Code	DN	Ø	□/田	€
191905007	1/2"	14	20/120	5,20
191907007	3/4"	18	20/80	6,93
191910007	1"	23	12/48	11,26
191912007	1*1/4	30	8/32	18,84
191915007	1*1/2	37	6/24	27,13
191920007	2"	47	4/16	42,65

IVR 919 LB



Valvola a sfera a passaggio standard - attacchi M/F, con maniglia blu
Standard bore ball valve - threaded ends M/F, with blue handle
Kugelhahn mit Standarddurchgang - AG/IG, mit blauem Hebelgriff
Vanne à boisseau sphérique à passage normal - fixations M/F, avec poignée bleu
Шаровой кран со стандартным проходом - соединения Н/В, с голубой ручкой

Cod./Code	DN	Ø	□/田	€
191905209	1/2"	14	20/120	5,20
191907209	3/4"	18	20/80	6,93
191910209	1"	23	12/48	11,26
191912209	1*1/4	30	8/32	18,84
191915209	1*1/2	37	6/24	27,13
191920209	2"	47	4/16	42,65



IVR 919 LN



Valvola a sfera a passaggio standard - attacchi M/F con maniglia nera
Standard bore ball valve - threaded ends M/F, with black handle
Kugelhahn mit Standarddurchgang - AG/IG, mit schwarzem Hebelgriff
Vanne à boisseau sphérique à passage normal - fixations M/F avec poignée noire
Шаровой кран со стандартным проходом, соединения Н/В, с черной ручкой

Cod./Code	DN	Ø	□/田	€
191905219	1/2"	14	20/120	5,20
191907219	3/4"	18	20/80	6,93
191910219	1"	23	12/48	11,26
191912219	1*1/4	30	8/32	18,84
191915219	1*1/2	37	6/24	27,13
191920219	2"	47	4/16	42,65



IVR 919/A



Valvola a sfera a passaggio standard - attacchi M/F, con farfalla rossa
Standard bore ball valve - threaded ends M/F, with red butterfly handle
Kugelhahn mit Standarddurchgang - AG/IG, mit rotem Flügelgriff
Vanne à boisseau sphérique à passage normal - fixations M/F, avec papillon rouge
Шаровой кран со стандартным проходом - соединения Н/В, с красной ручкой "бабочка"



Cod./Code	DN	Ø	□/田	€
191905008	1/2"	14	20/120	5,13
191907008	3/4"	18	20/80	6,86
191910008	1"	23	12/48	11,09

IVR 919/A FB



Valvola a sfera a passaggio standard - attacchi M/F, con farfalla blu
Standard bore ball valve - threaded ends M/F, with blue butterfly handle
Kugelhahn mit Standarddurchgang - AG/IG, mit blauem Flügelgriff
Vanne à boisseau sphérique à passage normal - fixations M/F, avec papillon bleu
Шаровой кран со стандартным проходом - соединения Н/В, с голубой ручкой "бабочка"



Cod./Code	DN	Ø	□/田	€
191905211	1/2"	14	20/120	5,13
191907211	3/4"	18	20/80	6,86
191910211	1"	23	12/48	11,09

IVR 919/A FN



Valvola a sfera a passaggio standard - attacchi M/F, con farfalla nera
Standard bore ball valve - threaded ends M/F, with black butterfly handle
Kugelhahn mit Standarddurchgang - AG/IG, mit schwarzem Flügelgriff
Vanne à boisseau sphérique à passage normal - fixations M/F, avec papillon noire
Шаровой кран со стандартным проходом - соединения Н/В, с чёрной ручкой "бабочка"



Cod./Code	DN	Ø	□/田	€
191905335	1/2"	14	20/120	5,13
191907335	3/4"	18	20/80	6,86
191910335	1"	23	12/48	11,09

IVR 920



Valvola a sfera a passaggio standard - attacchi M/M con maniglia rossa
Standard bore ball valve - threaded ends M/M with red handle
Kugelhahn mit Standarddurchgang - AG/AG, mit rotem Hebelgriff
Vanne à boisseau sphérique à passage normal - fixations M/M avec poignée rouge
Шаровой кран со стандартным проходом, соединения Н/Н, с красной ручкой



Cod./Code	DN	Ø	□/田	€
192005007	1/2"	14	20/120	5,01
192007007	3/4"	18	20/80	6,85

IVR 920 LB



Valvola a sfera a passaggio standard - attacchi M/M con maniglia blu
Standard bore ball valve - threaded ends M/M with blue handle
Kugelhahn mit Standarddurchgang - AG/AG, mit blauem Hebelgriff
Vanne à boisseau sphérique à passage normal - fixations M/M avec poignée bleue
Шаровой кран со стандартным проходом, соединения Н/Н, с голубой ручкой



Cod./Code	DN	Ø	□/田	€
192005209	1/2"	14	20/120	5,01
192007209	3/4"	18	20/80	6,85

IVR 920 LN



Valvola a sfera a passaggio standard - attacchi M/M con maniglia nera
Standard bore ball valve - threaded ends M/M with black handle
Kugelhahn mit Standarddurchgang - AG/AG, mit schwarzem Hebelgriff
Vanne à boisseau sphérique à passage normal - fixations M/M avec poignée noire
Шаровой кран со стандартным проходом, соединения Н/Н, с черной ручкой



Cod./Code	DN	Ø	□/田	€
192005219	1/2"	14	20/120	5,01
192007219	3/4"	18	20/80	6,85

IVR 920/A



Valvola a sfera a passaggio standard - attacchi M/M con farfalla rossa
Standard bore ball valve - threaded ends M/M with red butterfly handle
Kugelhahn mit Standarddurchgang - AG/AG, mit rotem Flügelgriff
Vanne à boisseau sphérique à passage normal - fixations M/M avec poignée papillon rouge
Шаровой кран со стандартным проходом, соединения Н/Н, с красной ручкой "бабочка"



Cod./Code	DN	Ø	□/田	€
192005008	1/2"	14	20/120	4,93
192007008	3/4"	18	20/80	6,78

IVR 920/A FB



Valvola a sfera a passaggio standard - attacchi M/M con farfalla blu
Standard bore ball valve - threaded ends M/M with blue butterfly handle
Kugelhahn mit Standarddurchgang - AG/AG, mit blauem Flügelgriff
Vanne à boisseau sphérique à passage normal - fixations M/M avec poignée papillon bleue
Шаровой кран со стандартным проходом, соединения Н/Н, с голубой ручкой "бабочка"



Cod./Code	DN	Ø	□/田	€
192005211	1/2"	14	20/120	4,93
192007211	3/4"	18	20/80	6,78

IVR 920/A FN



Valvola a sfera a passaggio standard - attacchi M/M con farfalla nera
Standard bore ball valve - threaded ends M/M with black butterfly handle
Kugelhahn mit Standarddurchgang - AG/AG, mit schwarzem Flügelgriff
Vanne à boisseau sphérique à passage normal - fixations M/M avec poignée papillon noire
Шаровой кран со стандартным проходом, соединения Н/Н, с черной ручкой "бабочка"



Cod./Code	DN	Ø	□/田	€
192005335	1/2"	14	20/120	4,93
192007335	3/4"	18	20/80	6,78

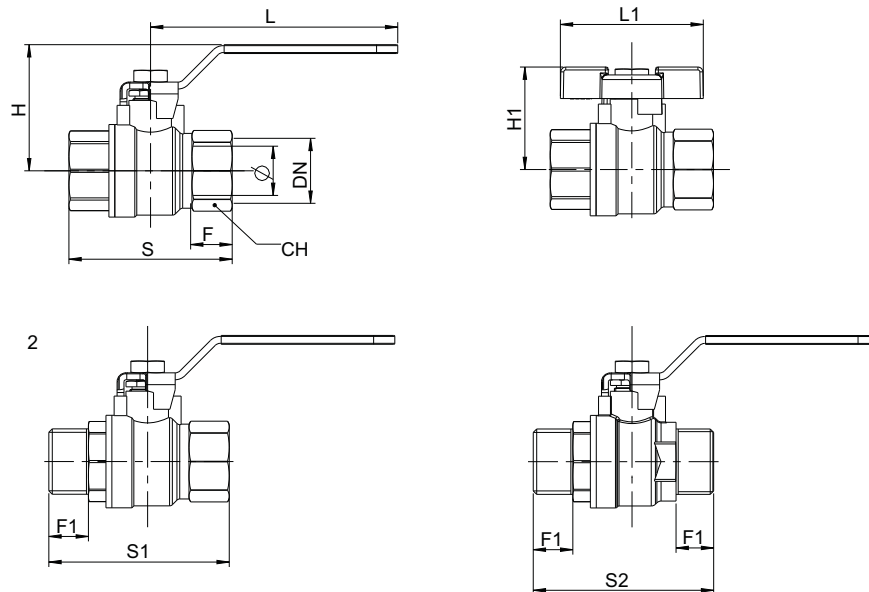

EVERMID

DIMENSIONI / DIMENSIONS

DN	Ø	S	S1	S2	L	L1	L2	L3	H	H1	H2	H3	F	F1	CH
1/2"	14	46	53	53	80	50			43	36			11	10	24
3/4"	18	52	58	58	80	50			45	39			11,5	11	30
1"	23	62	68		115	61			58	45			13,5	13	36
1"1/4	29	74	82		115				62				16	15	46
1"1/2	37	87	96		150				74				16,5	16	52
2"	47	98	107		150				81				17	17	65
2"1/2	50	109			140				85				20		83
3"	61	148			220				116				24		96
4"	74	XXX			220				116				27		121

EVERMID

ACCESSORI / RICAMBI - ACCESSORIES / SPARE PARTS

1/2"	700101001 € 0,61	700105001 € 0,61	700102001 € 0,60	703001501 € 0,51	703005001 € 0,56	703002001 € 0,56	750106001 € 0,43	125603440 € 1,94	125603600 € 1,94	109702030 € 5,30
3/4"	700101001 € 0,61	700105001 € 0,61	700102001 € 0,60	703001501 € 0,51	703005001 € 0,56	703002001 € 0,56	750106001 € 0,43	125603440 € 1,94	125603600 € 1,94	109702030 € 5,30
1"	700421001 € 0,92	700425001 € 0,91	700422001 € 0,92	703011501 € 0,70	703015001 € 0,70	703012001 € 0,70	750108001 € 0,44	125605440 € 2,37	125605600 € 2,37	109705030 € 6,76
1"1/4	700421001 € 0,92	700425001 € 0,91	700422001 € 0,92				750108001 € 0,44	125605440 € 2,37	125605600 € 2,37	109705030 € 6,76
1"1/2	700431001 € 1,40	700435001 € 1,40	700432001 € 1,40				750110001 € 0,48	125610440 € 3,01	125610600 € 3,01	109710030 € 9,06
2"	700431001 € 1,40	700435001 € 1,40	700432001 € 1,40				750110001 € 0,48	125610440 € 3,01	125610600 € 3,01	109710030 € 9,06
2"1/2	700131001 € 1,47	700135001 € 1,47	700132001 € 1,47				750114001 € 0,55			109715030 € 12,04
3"	700441001 € 3,66	700445001 € 3,66	700442001 € 3,66				750116001 € 0,59			109720010 € 35,04
4"	700441001 € 3,66	700445001 € 3,66	700442001 € 3,66				750116001 € 0,59			109720010 € 35,04

IVR 58 TUBO RAME



Valvola a sfera a passaggio totale - attacchi tubo rame a compressione
Full bore ball valve with compression ends for copper pipe
Kugelhahn mit vollem Durchgang - mit Kompression-Anschlüssen für Kupferrohr
Vanne à boisseau sphérique à passage intégral avec fixation tube en cuivre à compression
Полнопроходной шаровой кран - компрессионные соединения для медной трубы



Cod./Code	DN	Ø	□/田	€
105815007	15	15	20/80	7,53
105822007	22	20	20/80	11,44
105828007	28	25	10/40	17,54

IVR 58/A TUBO RAME



Valvola a sfera a passaggio totale - attacchi tubo rame a compressione
Full bore ball valve with compression ends for copper pipe
Kugelhahn mit vollem Durchgang - mit Kompression-Anschlüssen für Kupferrohr
Vanne à boisseau sphérique à passage intégral avec fixation tube en cuivre à compression
Полнопроходной шаровой кран - компрессионные соединения для медной трубы



Cod./Code	DN	Ø	□/田	€
105815002	15	15	20/80	7,53
105822002	22	20	20/80	11,44
105828002	28	25	10/40	17,54



IVR ELITE GW 4MS



50 bar

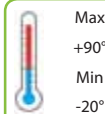

Max
+90°
Min
-20°



UNI EN 10226-1
(ISO 7-1 Rp)

IVR 100 GW 4MS



Valvola a sfera a passaggio totale per acqua potabile - Antilegionella, antigelo - attacchi F/F

Full bore ball valve for drinking water - anti-legionella and anti-freeze - threaded ends F/F

Kugelhahn mit vollem Durchgang - Antilegionellenfunktion - für Trinkwasser - IG/IG

Vanne à boisseau sphérique à passage intégral pour eau potable - anti-légionelle, antigel - fixations F/F

Полнопроходной шаровой кран для питьевой воды - конструкция «антилегионелла», с защитой от замерзания, соединения В/В

Cod./Code	DN	Ø	□/田	€
110003200	3/8"	10	10/120	4,05
110005200	1/2"	15	12/72	6,91
110007200	3/4"	20	15/60	9,23
110010200	1"	25	10/40	15,51
110012200	1*1/4	32	6/24	23,11
110015200	1*1/2	40	4/16	36,41
110020200	2"	50	2/8	54,19



IVR 100/A GW 4MS



Valvola a sfera a passaggio totale per acqua potabile - Antilegionella, antigelo - attacchi F/F

Full bore ball valve for drinking water - anti-legionella and anti-freeze - threaded ends F/F

Kugelhahn mit vollem Durchgang - Antilegionellenfunktion - für Trinkwasser - IG/IG

Vanne à boisseau sphérique à passage intégral pour eau potable - anti-légionelle, antigel - fixations F/F

Полнопроходной шаровой кран для питьевой воды - конструкция «антилегионелла», с защитой от замерзания, соединения В/В

Cod./Code	DN	Ø	□/田	€
110003201	3/8"	10	10/120	3,99
110005201	1/2"	15	12/72	6,81
110007201	3/4"	20	15/60	9,14
110010201	1"	25	10/40	15,27



IVR 101 GW 4MS



Valvola a sfera a passaggio totale per acqua potabile - Antilegionella, antigelo - attacchi M/F

Full bore ball valve for drinking water - anti-legionella and anti-freeze - threaded ends M/F

Kugelhahn mit vollem Durchgang - Antilegionellenfunktion - für Trinkwasser - AG/IG

Vanne à boisseau sphérique à passage intégral pour eau potable - anti-légionelle, antigel - fixations M/F

Полнопроходной шаровой кран для питьевой воды - конструкция «антилегионелла», с защитой от замерзания, соединения Н/В

Cod./Code	DN	Ø	□/田	€
110103200	3/8"	10	10/120	4,33
110105200	1/2"	15	12/72	7,29
110107200	3/4"	20	15/60	9,94
110110200	1"	25	10/40	16,30
110112200	1*1/4	32	6/24	25,01
110115200	1*1/2	40	4/16	39,52
110120200	2"	50	2/8	56,98



IVR 101/A GW 4MS



Valvola a sfera a passaggio totale per acqua potabile - Antilegionella, antigelo - attacchi M/F
Full bore ball valve for drinking water - anti-legionella and anti-freeze - threaded ends M/F
Kugelhahn mit vollem Durchgang-Antilegionellenfunktion - für Trinkwasser - AG/IG
Vanne à boisseau sphérique à passage intégral pour eau potable - anti-légionelle, antigel - fixations M/F
Полнопроходной шаровой кран для питьевой воды - конструкция «антилегионелла», с защитой от замерзания, соединения Н/В



Cod./Code	DN	Ø	□/田	€
110103201	3/8"	10	10/120	4,27
110105201	1/2"	15	12/72	7,19
110107201	3/4"	20	15/60	9,85
110110201	1"	25	12/48	16,07

IVR 208 GW 4MS SPURGO



Valvola a sfera a passaggio totale per acqua potabile - antilegionella, antigelo - con rubinetto di scarico - attacchi F/F
Full bore ball valve for drinking water - anti-legionella and anti-freeze - with drain valve threaded ends F/F
Kugelhahn mit vollem Durchgang und Ablasshahn - Antilegionellenfunktion - Für Trinkwasser - IG/IG
Vanne à boisseau sphérique à passage intégral pour eau potable - anti-légionelle, antigel - avec robinet de vidange - fixations F/F
Полнопроходной шаровой кран для питьевой воды - конструкция «антилегионелла» с защитой от замерзания - со спускным краном - соединения В/В



Cod./Code	DN	Ø	□/田	€
120805215	1/2"	15	10/40	11,96
120807215	3/4"	20	10/50	14,54
120810215	1"	25	12/48	21,10
120812215	1"1/4	32	8/32	27,91
120815215	1"1/2	40	4/16	44,73
120820215	2"	50	2/8	68,03

IVR 208/A GW 4MS SPURGO



Valvola a sfera a passaggio totale per acqua potabile - antilegionella, antigelo - con rubinetto di scarico - attacchi F/F
Full bore ball valve for drinking water - anti-legionella and anti-freeze - with drain valve threaded ends F/F
Kugelhahn mit vollem Durchgang und Ablasshahn - Antilegionellenfunktion - Für Trinkwasser - IG/IG
Vanne à boisseau sphérique à passage intégral pour eau potable - anti-légionelle, antigel - avec robinet de vidange - fixations F/F
Полнопроходной шаровой кран для питьевой воды - конструкция «антилегионелла» с защитой от замерзания - со спускным краном - соединения В/В



Cod./Code	DN	Ø	□/田	€
120805216	1/2"	15	10/40	11,87
120807216	3/4"	20	20/80	14,39
120810216	1"	25	12/48	20,87
120812216	1"1/4	32	8/32	27,67

IVR 137 GW 4MS RIDUTTORE



Valvola a sfera a passaggio totale per acqua potabile - antilegionella, antigelo - con riduttore di manovra - attacchi F/F

Full bore ball valve for drinking water - anti-legionella and anti-freeze - with gauge handle threaded ends F/F

Kugelhahn mit vollem Durchgang und Getriebe - Antilegionellenfunktion - für Trinkwasser - IG/IG

Vanne à boisseau sphérique à passage intégral pour eau potable - anti-légionelle, antigel - avec réducteur de manoeuvre - fixations F/F

Полнопроходной шаровой кран для питьевой воды - конструкция «антилегионелла» с защитой от замерзания - с редуктором управления - соединения В/В

Cod./Code	DN	Ø	□/田	€
113703200	3/8"	10	12/48	11,23
113705200	1/2"	15	9/36	12,97
113707200	3/4"	20	8/32	15,39
113710200	1"	25	8/32	21,81
113712200	1"1/4	32	6/24	29,56
113715200	1"1/2	40	2/8	45,74
113720200	2"	50	2/8	64,41



IVR 157 GW 4MS RIDUTTORE



Valvola a sfera a passaggio totale per acqua potabile - antilegionella, antigelo - con riduttore di manovra - attacchi M/F

Full bore ball valve for drinking water - anti-legionella and anti-freeze - with gauge handle threaded ends M/F

Kugelhahn mit vollem Durchgang und Getriebe - Antilegionellenfunktion - für Trinkwasser - AG/IG

Vanne à boisseau sphérique à passage intégral pour eau potable - anti-légionelle, antigel - avec réducteur de manoeuvre - fixations M/F

Полнопроходной шаровой кран для питьевой воды - конструкция «антилегионелла» с защитой от замерзания - с редуктором управления - соединения Н/В

Cod./Code	DN	Ø	□/田	€
115703200	3/8"	10	15/60	10,55
115705200	1/2"	15	9/36	13,20
115707200	3/4"	20	8/32	15,95
115710200	1"	25	8/32	22,16
115712200	1"1/4	32	6/24	31,56
115715200	1"1/2	40	2/8	49,01
115720200	2"	50	2/8	67,36



IVR 120 GW 4MS CAPPUCCIO SIGILLABILE



Valvola a sfera a passaggio totale per acqua potabile - Antilegionella, antigelo con cappuccio sigillabile - attacchi F/F

Full bore ball valve for drinking water - anti-legionella and anti-freeze - with sealing cap ends F/F

Kugelhahn mit vollem Durchgang - Antilegionellenfunktion - für Trinkwasser mit abdichtbarer Kappe - IG/IG

Vanne à boisseau sphérique à passage intégral pour eau potable - anti-légionelle, antigel - avec capouchon scellable - fixations F/F

Полнопроходной шаровой кран для питьевой воды - конструкция «антилегионелла» с защитой от замерзания - с колпачком под пломбировку - соединения В/В

Cod./Code	DN	Ø	□/田	€
112005200	1/2"	15	10/60	8,37
112007200	3/4"	20	15/60	10,68
112010200	1"	25	10/40	16,52
112012200	1"1/4	32	6/24	23,86
112015200	1"1/2	40	5/20	36,69
112020200	2"	50	2/8	54,51



IVR 121 GW 4MS CAPPUCCIO SIGILLABILE



Valvola a sfera a passaggio totale per acqua potabile - Antilegionella, antigelo con cappuccio sigillabile - attacchi M/F

Full bore ball valve for drinking water - anti-legionella and anti-freeze - with sealing cap ends M/F

Kugelhahn mit vollem Durchgang - Antilegionellenfunktion-für Trinkwasser mit abdichtbarer Kappe - AG/IG

Vanne à boisseau sphérique à passage intégral pour eau potable - anti-légionelle, antigel - avec capouchon scellable - fixations M/F

Полнопроходной шаровой кран для питьевой воды - конструкция «антилегионелла» с защитой от замерзания - с колпачком под пломбировку - соединения Н/В

Cod./Code	DN	Ø	□/⊕	€
112105200	1/2"	15	10/60	8,71
112107200	3/4"	20	15/60	11,37
112110200	1"	25	10/40	17,26
112112200	1" 1/4	32	6/24	25,76
112115200	1" 1/2	40	5/2	39,78
112120200	2"	50	2/8	57,30

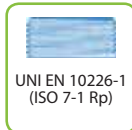
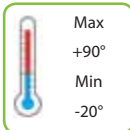
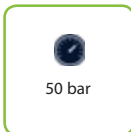

IVR ELITE GW 4MS KIWA

IVR 100 GW 4MS KIWA



Valvola a sfera a passaggio totale per acqua potabile - omologata KIWA - attacchi F/F

Full bore ball valve for drinking water - KIWA certified - F/F

Kugelhahn mit vollem Durchgang für Trinkwasser - Zulassung KIWA - IG/IG

Vanne à boisseau sphérique à passage intégral - certification KIWA - F/F

Полнопроходной шаровой кран для питьевой воды - сертификат KIWA - соединения В/В

Cod./Code	DN	Ø	□/⊕	€
110003224	3/8"	10	10/120	4,94
110005224	1/2"	15	12/72	8,35
110007224	3/4"	20	20/80	10,64
110010224	1"	25	10/40	17,64



Cod./Code	DN	Ø	□/⊕	€
113712200	1" 1/4	32	6/24	29,56
113715200	1" 1/2	40	4/16	45,74
113720200	2"	50	2/8	64,41



IVR 101 GW 4MS KIWA



Valvola a sfera a passaggio totale per acqua potabile - omologata KIWA - attacchi M/F
Full bore ball valve for drinking water - KIWA certified - M/F
Kugelhahn mit vollem Durchgang für Trinkwasser - Zulassung KIWA - AG/IG
Vanne à boisseau sphérique à passage intégral - certification KIWA - M/F
Полнопроходной шаровой кран для питьевой воды - сертификат KIWA - соединения Н/В

Cod./Code	DN	Ø	□/田	€
110103224	3/8"	10	10/120	5,20
110105224	1/2"	15	12/72	8,73
110107224	3/4"	20	15/60	11,33
110110224	1"	25	10/40	18,44

Cod./Code	DN	Ø	□/田	€
115712200	1" 1/4	32	6/24	31,56
115715200	1" 1/2	40	4/16	49,01
115720200	2"	50	2/8	67,36



IVR 208 GW 4MS KIWA



Valvola a sfera a passaggio totale per acqua potabile con spurgo - omologata KIWA - attacchi F/F
Full bore ball valve for drinking water with drain - KIWA certified - F/F
Kugelhahn mit vollem Durchgang für Trinkwasser mit Ablasshahn - Zulassung KIWA - IG/IG
Vanne à boisseau sphérique à passage intégral pour eau potable avec robinet d'évacuation- certification KIWA - F/F
Полнопроходной шаровой кран для питьевой воды со спускным краном - сертификат KIWA - соединения В/В





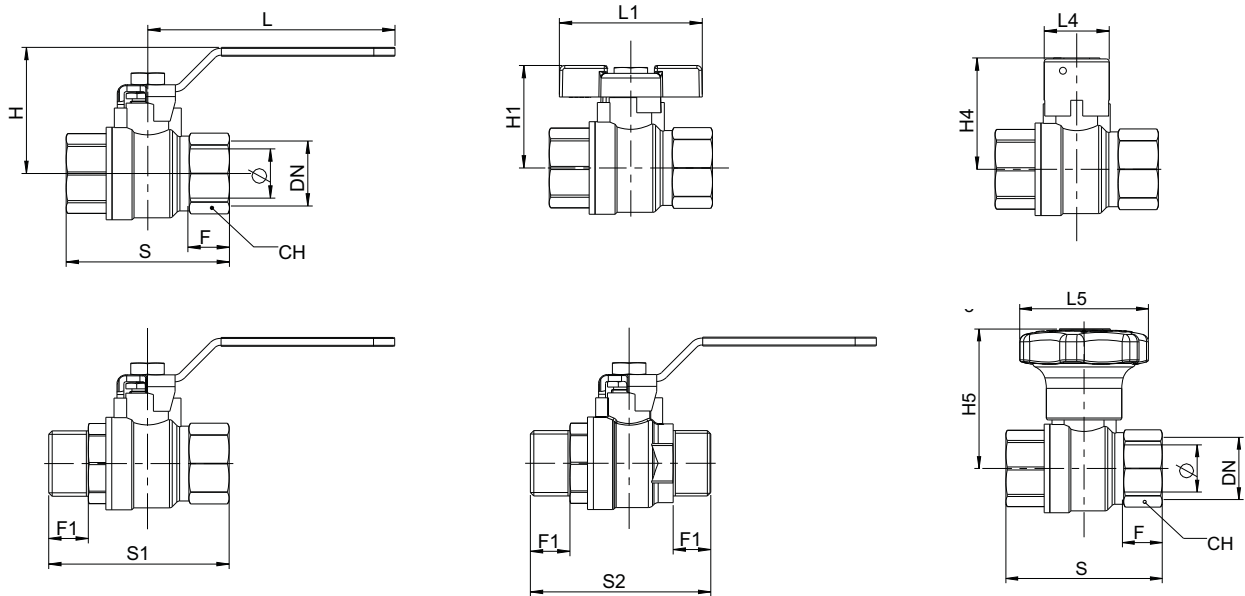

Cod./Code	DN	Ø	□/田	€
120805224	1/2"	15	10/60	10,99
120807224	3/4"	20	20/80	13,51
120810224	1"	25	12/48	20,94

Cod./Code	DN	Ø	□/田	€
120812227	1" 1/4	32	8/32	31,44
120815227	1" 1/2	40	4/16	50,14
120820227	2"	50	2/8	73,26





ELITE GW		DIMENSIONI / DIMENSIONS													
DN	Ø	S	S1	S2	L	L1	L4	L5	H	H1	H4	H5	F	F1	CH
3/8"	10	45	54	54	80	50		70	41	33		59	12	12	21
1/2"	15	63	70	68	90	61	29	70	52	39	45	65	17	15	26
3/4"	20	71	80	77	90	61	29	70	55	43	49	68	19,5	15,6	31
1"	25	83	92	92	125	72	33	70	65		56	76	21	19	38
1 1/4"	32	92	102		125		33	70	69		61	81	22	20,5	48
1 1/2"	40	104	117		140		44	112	78		75	105	23,5	21,5	55
2"	50	124	137		140		44	112	85		82	112	28	24,5	68

ELITE GW		ACCESSORI / RICAMBI - ACCESSORIES / SPARE PARTS				
						
3/8"	700107001 € 0,60	703007001 € 0,51	750106001 € 0,43	707007001 € 6,74		109702030 € 5,30
1/2"	700117001 € 0,78	703017001 € 0,70	750108001 € 0,44	707017001 € 6,75	706017000 € 1,60	109705030 € 6,76
3/4"	700117001 € 0,78	703017001 € 0,70	750108001 € 0,44	707017001 € 6,75	706017000 € 1,60	109705030 € 6,76
1"	700127001 € 1,24	703027001 € 0,83	750110001 € 0,48	707027001 € 6,75	706027000 € 1,73	109710030 € 9,06
1 1/4"	700127001 € 1,24	703027001 € 0,83	750110001 € 0,48	707027001 € 6,75	706027000 € 1,73	109710030 € 9,06
1 1/2"	700137001 € 1,47		750114001 € 0,55	707037001 € 10,21	706037000 € 2,39	109715030 € 12,04
2"	700137001 € 1,47		750114001 € 0,55	707037001 € 10,21	706037000 € 2,39	109715030 € 12,04

IVR SOLAR LINE



50 bar



Max
+180°
Min
-30°



UNI ISO 228-1

IVR 440



EAC

Valvola a sfera a passaggio totale - SOLAR LINE - attacchi F/F

Full bore ball valve SOLAR LINE - threaded ends F/F

Kugelhahn mit vollem Durchgang - SOLAR LINE - IG/IG

Vanne à boisseau sphérique à passage intégral SOLAR LINE - fixations F/F

Полнопроходной шаровой кран - SOLAR LINE - соединения В/В

Cod./Code	DN	Ø	□/田	€
144003007	3/8"	10	10/60	5,08
144005007	1/2"	15	12/48	8,47
144007007	3/4"	20	12/48	11,00
144010007	1"	25	8/32	17,89
144012007	1"1/4	32	6/24	25,35
144015007	1"1/2	40	4/16	38,51
144020007	2"	50	2/8	58,20

IVR 440/A



EAC

Valvola a sfera a passaggio totale - SOLAR LINE - attacchi F/F

Full bore ball valve SOLAR LINE - threaded ends F/F

Kugelhahn mit vollem Durchgang - SOLAR LINE - IG/IG

Vanne à boisseau sphérique à passage intégral SOLAR LINE - fixations F/F

Полнопроходной шаровой кран - SOLAR LINE - соединения В/В

Cod./Code	DN	Ø	□/田	€
144003008	3/8"	10	10/60	4,96
144005008	1/2"	15	12/48	8,16
144007008	3/4"	20	12/48	10,68
144010008	1"	25	8/32	17,18

IVR 441



EAC

Valvola a sfera a passaggio totale - SOLAR LINE - attacchi M/F

Full bore ball valve SOLAR LINE - threaded ends M/F

Kugelhahn mit vollem Durchgang - SOLAR LINE - AG/IG

Vanne à boisseau sphérique à passage intégral SOLAR LINE - fixations M/F

Полнопроходной шаровой кран - SOLAR LINE - соединения Н/В

Cod./Code	DN	Ø	□/田	€
144103007	3/8"	10	10/60	5,45
144105007	1/2"	15	12/48	8,77
144107007	3/4"	20	12/48	11,46
144110007	1"	25	8/32	18,68
144112007	1"1/4	32	6/24	27,79
144115007	1"1/2	40	4/16	41,76
144120007	2"	50	2/8	61,39

IVR 441/A



EAC

Valvola a sfera a passaggio totale - SOLAR LINE - attacchi M/F
Full bore ball valve SOLAR LINE - threaded ends M/F
Kugelhahn mit vollem Durchgang - SOLAR LINE - AG/IG
Vanne à boisseau sphérique à passage intégral SOLAR LINE - fixations M/F
Полнопроходной шаровой кран - SOLAR LINE - соединения H/B

Cod./Code	DN	Ø	□/田	€
144103008	3/8"	10	10/60	5,34
144105008	1/2"	15	12/48	8,47
144107008	3/4"	20	12/48	11,12
144110008	1"	25	8/32	17,97

IVR 442



EAC

Valvola automatica sfiato aria
Automatic air-vent valve
Automatisches Entlüftungsventil
Vanne automatique de purge d'air
Автоматический воздухоотводчик

Cod./Code	DN	Ø	□/田	€
144203001	3/8"	10	8/48	11,06
144205001	1/2"	15	8/48	11,06

IVR 443



EAC

Valvola sicurezza F/F
Safety valve F/F
Sicherheitsventil, IG/IG
Groupe de sécurité F/F
Предохранительный клапан В/В

Cod./Code	DN	Ø	□/田	€
144305301	1/2"x3/4" - 3 bar	10	10/60	17,45
144305401	1/2"x3/4" - 4 bar	15	10/60	17,45
144305601	1/2"x3/4" - 6 bar	20	10/60	17,45

IVR 759

NEW



Valvola miscelatrice termostatica a 3 vie per impianti solari - attacchi F/F/F
3-way thermostatic mixing valve for solar systems - F/F/F
3-Wege thermostatisches Mischventil für Solaranlagen - IG/IG/IG
Soupape de mélange à 3 voies thermostatique pour systèmes solaires - F/F/F
3-ходовой термостатический смесительный клапан для солнечных систем - соединения В/В/В

Cod./Code	DN	□/田	€
175905001	1/2"	1	73,26
175907001	3/4"	1	73,26
175910001	1"	1	76,27

IVR 760



Valvola miscelatrice termostatica a 3 vie per impianti solari - attacchi M/M/M
3-way thermostatic mixing valve for solar systems - M/M/M
3-Wege thermostatisches Mischventil für Solaranlagen - AG/AG/AG
Soupape de mélange à 3 voies thermostatique pour systèmes solaires - M/M/M
3-ходовой термостатический смесительный клапан для солнечных систем - соединения Н/Н/Н

Cod./Code	DN	□/田	€
176007001	3/4"	1	87,78
176010001	1"	1	93,40

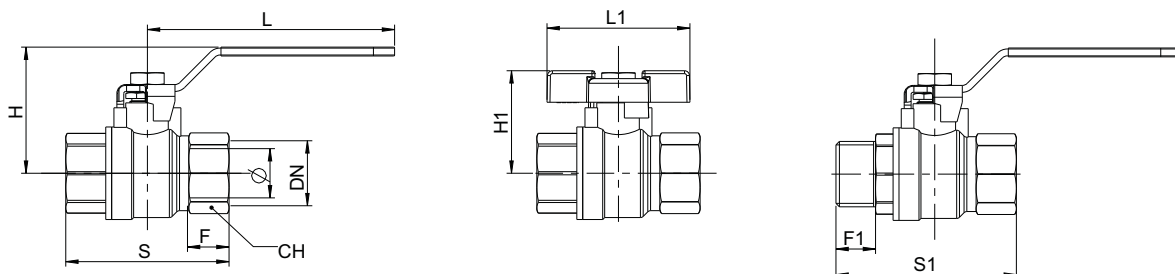

SOLAR

DIMENSIONI / DIMENSIONS

DN	Ø	S	S1	S2	L	L1	L2	L3	H	H1	H2	H3	F	F1	CH
3/8"	10	45	54		80	50			40	33			12	12	21
1/2"	15	63	70		90	61			52	39			17	15	26
3/4"	20	71	80		90	61			55	43			19,5	16	31
1"	25	83	92		125	72			64	52			21	19	38
1"1/4	32	92	102		125				69	57			22	20,5	48
1"1/2	40	104	117		140				78				23,5	21,5	55
2"	50	124	137		140				85				28	24,5	68

SOLAR

ACCESSORI / RICAMBI - ACCESSORIES / SPARE PARTS

	3/8"	1/2"	3/4"	1"	1"1/4	1"1/2	2"
	701604001 € 0,84	701614001 € 1,25	701614001 € 1,25	701624001 € 1,83	701624001 € 1,83	701634001 € 2,56	701634001 € 2,56
	703004001 € 0,56	703014001 € 0,70	703014001 € 0,70	703024001 € 0,83			
	750306001 € 0,48	750308001 € 0,59	750308001 € 0,59	750310001 € 0,90	750310001 € 0,90	750314001 € 1,71	750314001 € 1,71

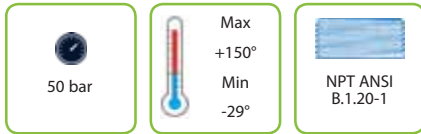

IVR NPT

IVR 45 NPT EXPORT NPT



Valvola a sfera a passaggio totale - attacchi F/F NPT
Full bore ball valve - threaded ends F/F NPT
Kugelhahn mit vollem Durchgang - IG/IG NPT
Vanne à boisseau sphérique à passage intégral - fixations F/F avec filetage NPT
Полнопроходной шаровой кран - соединения В/В NPT

Cod./Code	DN	Ø	□/田	€
104502090	1/4"	10	10/120	4,48
104503090	3/8"	10	10/120	4,13
104505090	1/2"	15	20/80	7,27
104507090	3/4"	20	12/48	9,89
104510090	1"	25	10/40	16,05
104512090	1"1/4	32	5/20	22,66
104515090	1"1/2	40	4/16	35,45
104520090	2"	50	2/8	55,69
104525090	2"1/2	61	6	123,39
104530090	3"	74	4	171,64
104540090	4"	95	2	282,00



IVR 45/A NPT EXPORT NPT



Valvola a sfera a passaggio totale - attacchi F/F NPT
Full bore ball valve - threaded ends F/F NPT
Kugelhahn mit vollem Durchgang - IG/IG NPT
Vanne à boisseau sphérique à passage intégral - fixations F/F avec filetage NPT
Полнопроходной шаровой кран - соединения В/В NPT

Cod./Code	DN	Ø	□/田	€
104502089	1/4"	10	10/120	4,40
104503089	3/8"	10	10/120	4,06
104505089	1/2"	15	12/72	7,18
104507089	3/4"	20	15/60	9,78
104510089	1"	25	10/40	15,79



IVR 607 NPT



Saracinesca PN16 - volantino in acciaio - attacchi F/F NPT
Gate valve PN16 - handle in steel - F/F NPT
Absperrentil PN16 - Handrad aus Stahl - IG/IG NPT
Vanne à opercule PN16 - volant d'acier - F/F NPT
Шиберный клапан PN16 - со стальным маховиком - соединения В/В NPT

Cod./Code	DN	□/田	€
160705001	1/2"	20/80	7,02
160707001	3/4"	20/80	8,60
160710001	1"	12/48	12,21
160712001	1"1/4	12/48	16,26
160715001	1"1/2	8/32	24,04
160720001	2"	2/8	34,42



IVR DZR

IVR 20



Valvola a sfera a passaggio totale in DZR - attacchi F/F
DZR brass full bore ball valve - threaded ends F
Kugelhahn mit vollem Durchgang in DZR - IG/IG
Vanne à boisseau sphérique à passage intégral in DZR - fixations F/F
Полнопроходной шаровой кран из латуни DZR - соединения В/В

Cod./Code	DN	Ø	□/田	€
102003010	3/8"	10	10/120	7,06
102005010	1/2"	15	20/80	7,69
102007010	3/4"	20	15/60	10,46
102010010	1"	25	10/40	17,73
102012010	1"1/4	32	6/24	26,24
102015010	1"1/2	40	4/16	38,65
102020010	2"	50	4/16	59,00

IVR 20/A





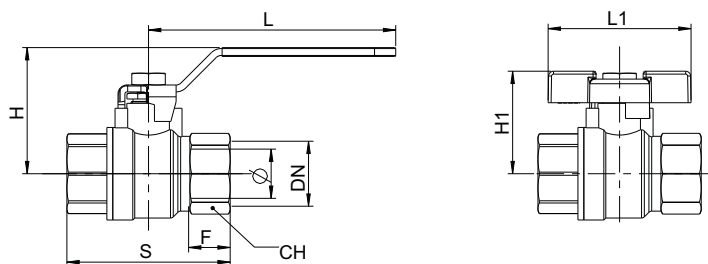

Valvola a sfera a passaggio totale in DZR - attacchi F/F
DZR brass full bore ball valve - threaded ends F/F
Kugelhahn mit vollem Durchgang in DZR - IG/IG
Vanne à boisseau sphérique à passage intégral in DZR - fixations F/F
Полнопроходной шаровой кран из латуни DZR - соединения В/В

Cod./Code	DN	Ø	□/田	€
102003011	3/8"	10	10/120	6,99
102005011	1/2"	15	20/80	7,59
102007011	3/4"	20	15/60	10,37
102010011	1"	25	10/40	17,50



DZR		DIMENSIONI / DIMENSIONS													
DN	Ø	S	S1	S2	L	L1	L2	L3	H	H1	H2	H3	F	F1	CH
3/8"	10	45			80	50			40	33			12		21
1/2"	15	55			90	61			52	39			13,5		25
3/4"	20	61			90	61			55	43			14,5		31
1"	25	72			125	72			64	52			16		38
1"1/4	32	81			125				69	57			17		47
1"1/2	40	94			140				78				18		54
2"	50	112			140				85				22		66

DZR		ACCESSORI / RICAMBI - ACCESSORIES / SPARE PARTS			
					
3/8"	700101001 € 0,61	703001501 € 0,51	750106001 € 0,43	109702030 € 5,30	
1/2"	700111001 € 0,78	703011501 € 0,70	750108001 € 0,44	109705030 € 6,76	
3/4"	700111001 € 0,78	703011501 € 0,70	750108001 € 0,44	109705030 € 6,76	
1"	700121001 € 1,05	703021501 € 0,83	750110001 € 0,48	109710030 € 9,06	
1"1/4	700121001 € 1,05		750110001 € 0,48	109710030 € 9,06	
1"1/2	700131001 € 1,47		750114001 € 0,55	109715030 € 12,04	
2"	700131001 € 1,47		750114001 € 0,55	109715030 € 12,04	

IVR 25



Valvola a sfera a passaggio totale in DZR - attacchi tubo rame compressione
DZR brass full bore ball valve with compression ends for copper pipe
Kugelhahn mit vollem Durchgang in DZR - Kompression-Anschlüsse für Kupferrohr
Vanne à boisseau sphérique à passage intégral in DZR - fixations tube cuivre compression
Полнопроходной шаровой кран из латуни DZR - компрессионные соединения для медной трубы

Cod./Code	DN	Ø	□/田	€
102505010	15	15	20/80	9,84
102507010	22	20	20/80	13,55
102510010	28	25	10/40	21,72

IVR 25/A



Valvola a sfera a passaggio totale in DZR - attacchi tubo rame compressione
DZR brass full bore ball valve with compression ends for copper pipe
Kugelhahn mit vollem Durchgang in DZR - Kompression-Anschlüsse für Kupferrohr
Vanne à boisseau sphérique à passage intégral in DZR - fixations tube cuivre compression
Полнопроходной шаровой кран из латуни DZR - компрессионные соединения для медной трубы

Cod./Code	DN	Ø	□/田	€
102505011	15	15	20/80	9,75
102507011	22	20	20/80	13,45
102510011	28	25	10/40	21,49

IVR 210 NORDICA



Valvola a sfera a passaggio totale in DZR con asta prolungata - attacchi F/F
DZR brass full bore ball valve with extension stem - threaded ends F/F
Kugelhahn mit vollem Durchgang in DZR mit verlängertem Spindel - IG/IG
Vanne à boisseau sphérique à passage intégral in DZR avec tige rallonge - fixations F/F
Полнопроходной шаровой кран из латуни DZR с удлиненным штоком - соединения В/В

SU RICHIESTA
ON DEMAND

LOTTO MINIMO
MINIMUM BATCH

Cod./Code	DN	Ø	□/田	€
121003010	3/8"	10	10/60	11,34
121005010	1/2"	15	10/40	14,69
121007010	3/4"	20	10/40	17,61
121010010	1"	25	10/40	26,12
121012010	1 1/4"	32	4/16	34,06
121015010	1 1/2"	40	2/8	49,34
121020010	2"	50	2/8	69,04

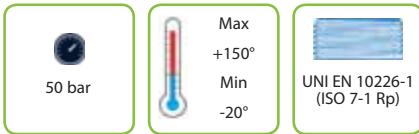

IVR NORDIKA

IVR 200 NORDIKA



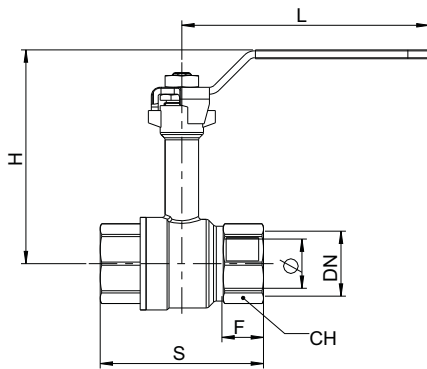

Valvola a sfera a passaggio totale con asta prolungata - attacchi F/F
Brass full bore ball valve with extension stem - threaded ends F/F
Kugelhahn mit vollem Durchgang und verlängerter Spindel - IG/IG
Vanne à boisseau sphérique à passage intégral avec tige rallonge - fixations F/F
Полнопроходной шаровой кран с удлиненным штоком - соединения В/В

Cod./Code	DN	Ø	□/田	€
120005007	1/2"	15	10/40	13,42
120007007	3/4"	20	10/40	15,97
120010007	1"	25	10/40	22,98
120012007	1"1/4	32	4/16	32,10
120015007	1"1/2	40	2/8	48,80
120020007	2"	50	2/8	67,79
120025007	2" 1/2	60	1/5	181,53



NORDIKA ACCESSORI / RICAMBI - ACCESSORIES / SPARE PARTS

		
1/2"	700111001 € 0,78	750108001 € 0,44
3/4"	700111001 € 0,78	750108001 € 0,44
1"	700121001 € 1,05	750110001 € 0,48
1"1/4	700121001 € 1,05	750110001 € 0,48
1"1/2	700131001 € 1,47	750114001 € 0,55
2"	700131001 € 1,47	750114001 € 0,55

NORDIKA

DIMENSIONI / DIMENSIONS

DN	Ø	S	S1	S2	L	L1	L2	L3	H	H1	H2	H3	F	F1	CH
1/2"	15	63			90				96				17		26
3/4"	20	71			90				100				19,5		31
1"	25	83			125				109				21		38
1"1/4	32	92			125				114				22		48
1"1/2	40	104			140				131				23,5		55
2"	50	124			140				139				28		68

IVR DRAIN

20 bar

Max
+90°
Min
-20°

UNI EN 10226-1
(ISO 7-1 Rp)

IVR 68 SPURGO



Valvola a sfera a passaggio totale con tappo e rubinetto di scarico - attacchi F/F

Full bore ball valve with cap and drain tap - threaded ends F/F

Kugelhahn mit vollem Durchgang, Deckel und Ablasshahn - IG/IG

Vanne à boisseau sphérique à passage intégral avec bouchon et robinet d'évacuation - fixations F/F

Полнопроходной шаровой клапан с заглушкой и спускным краником - соединения В/В

Cod./Code	DN	Ø	□/田	€
106805007	1/2"	15	10/60	8,79
106807007	3/4"	20	20/80	11,14
106810007	1"	25	12/48	16,90
106812007	1"1/4	32	8/32	24,22
106815007	1"1/2	40	4/16	32,32
106820007	2"	50	4/16	49,84



NOTA: Disponibile anche, con maniglia blu o nera

NOTE: Available with blue or black handle

ANMERKUNG: Erhältlich auch mit blauem oder schwarzem Griff

NOTE: Disponible, avec poignée bleu ciel ou noire

ПРИМЕЧАНИЕ: Доступен также с голубой или чёрной рукояткой

IVR 68/A SPURGO



Valvola a sfera a passaggio totale con tappo e rubinetto di scarico - attacchi F/F

Full bore ball valve with cap and drain tap - threaded ends F/F

Kugelhahn mit vollem Durchgang, Deckel und Ablasshahn - IG/IG

Vanne à boisseau sphérique à passage intégral avec bouchon et robinet d'évacuation - fixations F/F

Полнопроходной шаровой клапан с пробкой и дренажным краном - соединения В/В

Cod./Code	DN	Ø	□/田	€
106805002	1/2"	15	10/60	8,72
106807002	3/4"	20	20/80	11,03
106810002	1"	25	12/48	16,80



NOTA: Disponibile anche, con farfalla blu o nera

NOTE: Available with blue or black butterfly handle

ANMERKUNG: Erhältlich auch mit hellblauem oder schwarzem Flügelgriff

NOTE: Disponible aussi, avec papillon bleu ciel ou noir

ПРИМЕЧАНИЕ: Доступен также с голубой или чёрной ручкой-бабочкой

IVR 69 SPURGO



Valvola a sfera a passaggio totale con tappo e rubinetto scarico - attacchi M/F

Full bore ball valve with cap and drain tap - threaded ends M/F

Kugelhahn mit vollem Durchgang, Deckel und Ablasshahn - AG/IG

Vanne à boisseau sphérique à passage intégral avec bouchon et robinet d'évacuation - fixations M/F

Полнопроходной шаровой кран с заглушкой и спускным краником - соединения Н/В

Cod./Code	DN	Ø	□/田	€
106905007	1/2"	15	10/60	9,23
106907007	3/4"	20	20/80	11,48
106910007	1"	25	12/48	17,49



NOTA: Disponibile anche, con maniglia blu o nera

NOTE: Available with blue or black handle

ANMERKUNG: Erhältlich auch mit blauem oder schwarzem Griff

NOTE: Disponible, avec poignée bleu ciel ou noire

ПРИМЕЧАНИЕ: Доступен также с голубой или чёрной рукояткой

IVR 69/A SPURGO



Valvola a sfera a passaggio totale con tappo e rubinetto scarico - attacchi M/F
Full bore ball valve with cap and drain tap - threaded ends M/F
Kugelhahn mit vollem Durchgang, Deckel und Ablasshahn - AG/IG
Vanne à boisseau sphérique à passage intégral avec bouchon et robinet d'évacuation - fixations M/F
Полнопроходной шаровой кран с заглушкой и спускным краником - соединения Н/В

Cod./Code	DN	Ø	□/田	€
106905008	1/2"	15	10/60	9,17
106907008	3/4"	20	20/80	11,37
106910008	1"	25	12/48	17,40



NOTA: Disponibile anche con farfalla azzurra o nera
NOTE: Available with blue or black butterfly handle
ANMERKUNG: Erhältlich auch mit hellblauem oder schwarzem Flügelgriff
NOTE: Disponible aussi, avec papillon bleu ciel ou noir
ПРИМЕЧАНИЕ: Доступен также с голубой или чёрной ручкой-бабочкой

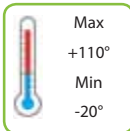
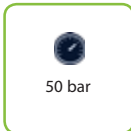

IVR BOCCHETTONE

IVR 60/A - 60/B BOCCHETTONE



Valvola a sfera a passaggio totale con bocchettone - attacchi M/F, sede conica
Full bore ball valve with tail piece - threaded ends M/F, conical seat
Kugelhahn mit vollem Durchgang und Rohrverschraubung - AG/IG, Kegelsitz
Vanne à boisseau sphérique à passage intégral avec raccord - fixations M/F, siège conique
Полнопроходной шаровой кран со сгоном и накидной гайкой - соединения Н/В, с коническим седлом



Cod./Code	Misura/Size	□/田	€
106005010	1/2" Rossa - Red	10/120	7,41
106005311	1/2" Blu - Blue	10/120	7,41
106007010	3/4" Rossa - Red	10/60	10,66
106007311	3/4" Blu - Blue butterfly	10/60	10,66
106010010	1" Rossa - Red	10/40	18,05
106010311	1" Blu - Blue	10/40	18,05
106012010	1"1/4 Rossa - Red	6/24	27,26
106012311	1"1/4 Blu - Blue	6/24	27,26

IVR 961/A - 961/B BOCCHETTONE A SQUADRA



Valvola a sfera a passaggio totale a squadra con bocchettone - attacchi M/F, sede conica
Angle full bore ball valve with tail piece - threaded ends M/F, conical seat
Kugelhahn mit vollem Durchgang, eckförmig, mit Stutzen Rohrverschraubung - AG/IG, Kegelsitz
Vanne à boisseau sphérique à passage intégral à équerre avec raccord - fixations M/F, siège conique
Полнопроходной угловой шаровой кран со сгоном и накидной гайкой - соединения Н/В, с коническим седлом



Cod./Code	Misura/Size	□/田	€
196105002	1/2" Rossa - Red	20/80	9,70
196105311	1/2" Blu - Blue	20/80	9,70
196107002	3/4" Rossa - Red	12/48	14,19
196107311	3/4" Blu - Blue	12/48	14,19
196110002	1" Rossa - Red	6/24	23,43
196110311	1" Blu - Blue	6/24	23,43

IVR ATTACCO SONDA

IVR 954 S



Valvola a sfera a passaggio totale - attacchi F/F - con portasonda
Full bore ball valve - threaded ends F/F - with sensor connection
Kugelhahn mit vollem Durchgang - IG/IG - mit Anschlüssen für Temperaturfühler
Vanne a sphère a passage total - fixations F/F - avec fixation sonde pour température
Полнопроходной шаровой кран: соединения В/В - с датчиком

Cod./Code	Misura/Size	□/田	€
195405711	1/2"	15/90	7,37
195407711	3/4"	20/60	9,29
195410711	1"	12/48	15,01

IVR 944/2 AS

NEW



Con bocchettone. Sede conica M/F
With tailpiece. Conical seat M/F
Mit Rohrverschraubung. Kegelsitz AG/IG
Avec raccord de tuyauterie. Siège conique M/F
Со сгоном. Коническое седло. Соединения - Н/В

Cod./Code	Misura/Size	□/田	€
194407079	3/4" x 3/4"	M10 x 1 10/40	16,51

IVR 809/A - 809/B BOCCHETTONE



Valvola a sfera M/F con bocchettone, termometro e attacco sonda per temperatura, sede conica
Ball valve M/F tail piece with thermometer and sensor connection, conical seat
Kugelhahn AG/IG, mit Rohrverschraubung, Thermometer und Anschluss für Temperaturfühler, Kegelsitz
Vanne à boisseau sphérique M/F avec raccord, thermomètre et fixation sonde pour température, siège conique
Шаровой кран с накидной гайкой - соединения Н/В для температурного сенсора, с коническим седлом

Cod./Code	Misura/Size	Ø	□/田	€
180910002	1" Red	23	10/40	31,08
180910011	1" Blue	23	10/40	31,08

IVR QUADRO

IVR 42 QUADRO 28



Valvola a sfera a passaggio totale - quadro di manovra 28mm - attacchi F/F
Full bore ball valve - square cap 28mm - threaded ends F/F
Kugelhahn mit vollem Durchgang - Schalttafel 28 mm - IG/IG
Vanne à boisseau sphérique à passage intégral - tableau de manoeuvre 28mm - fixations F/F
Полнопроходной шаровой кран - с квадратной головкой для управления 28 мм - соединения В/В

Cod./Code	DN	Ø	□/田	€
104205281	1/2"	15	10/60	11,77
104207281	3/4"	20	10/40	14,41
104210281	1"	25	10/40	20,11
104212281	1"1/4	32	6/24	27,46
104215281	1"1/2	40	5/20	40,97
104220281	2"	50	2/8	60,72

EAC

IVR 43 QUADRO 28



Valvola a sfera a passaggio totale - quadro di manovra 28mm - attacchi M/F
Full bore ball valve - square cap 28mm - threaded ends M/F
Kugelhahn mit vollem Durchgang - Schalttafel 28 mm - AG/IG
Vanne à boisseau sphérique à passage intégral - tableau de manoeuvre 28mm - fixations M/F
Полнопроходной шаровой кран - с квадратной головкой для управления 28 мм - соединения Н/В

Cod./Code	DN	Ø	□/田	€
104305281	1/2"	15	10/60	12,00
104307281	3/4"	20	10/40	14,89
104310281	1"	25	10/40	20,85
104312281	1"1/4	32	6/24	29,32
104315281	1"1/2	40	5/20	44,29
104320281	2"	50	2/8	63,73

EAC



IVR RIDUTTORE DI MANOVRA

IVR 137



Valvola a sfera a passaggio totale con riduttore di manovra - attacchi F/F
Full bore ball valve with gear - threaded ends F/F
Kugelhahn mit vollem Durchgang und Softgriff - IG/IG
Vanne à boisseau sphérique à passage intégral avec réducteur de manoeuvre - fixations F/F
Полнопроходной шаровой кран с ручкой-редуктором - соединения В/В

EAC

Cod./Code	DN	Ø	□/田	€
113702001	1/4"	10	12/48	10,48
113703001	3/8"	10	12/48	11,14
113705001	1/2"	15	9/36	12,73
113707001	3/4"	20	8/32	15,46
113710001	1"	25	8/32	21,87
113712001	1"1/4	32	6/24	29,62
113715001	1"1/2	40	2/8	45,84
113720001	2"	50	2/8	66,55
113725001	2"1/2	61	5	145,19

IVR 137 R MANIGLIA - TAPPO



Maniglia senza tappo per valvola riduttore - Tappo per maniglia
Handle for ball valve with geared-action without cap - Cap for handle
"Soft-Griff" ohne Deckel für Reduzierventil - Deckel für den Griff
Poignée sans bouchon pour vanne réducteur - Bouchon pour poignée
Ручка без пробки для клапана с редуктором - Пробка для ручки

Cod./Code	Misura/Size	Per articoli/For items/Für Artikel/pour article /Для изделия	□/田	€
339003451	3/8"	137	1	4,13
339005451	1/2" - 3/4"	137	1	4,13
339010451	1" - 1"1/4	137	1	4,13
339015451	1"1/2 - 2"1/2	137	1	6,69
339005452	1a MIS	1A MIS Orange - 137-157 - 3/8" - 1/2" - 3/4" - 1" - 1"1/4	1	0,65
339010452	2a MIS	2A MIS Orange - 137-157 - 1"1/2 - 2" - 2"1/2	1	0,89

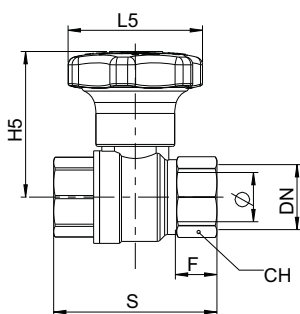

DIMENSIONI / DIMENSIONS

DN	Ø	S	L5	H5	F	CH
3/8"	10	45	70	59	12	21
1/2"	15	63	70	65	17	26
3/4"	20	71	70	68	19,5	31
1"	25	83	70	76	21	38
1"1/4	32	92	70	81	22	48
1"1/2	40	104	112	105	23,5	55
2"	50	124	112	112	28	68
2"1/2	60	140	112	162	28	85

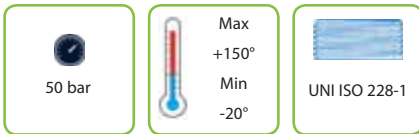

IVR TRE VIE

IVR 70 TRE VIE L



Valvola a sfera a tre vie a passaggio ridotto sfera forata a "L" - attacchi F/F/F
3-way valve with reduced bore and perforated ball type L - threaded ends F/F/F
3-Wege-Kugelhahn mit reduziertem Durchgang, Kugel mit L-Bohrung - IG/IG/IG

Vanne à boisseau sphérique à trois voies à passage réduit sphère percée en "L" - fixations F/F/F

Трехходовой шаровой кран с редуцированным проходом, сфера с «L» образным отверстием - соединения В/В/В

Cod./Code	DN	Ø	□/田	€
107002003	1/4"	10	5/30	23,67
107003003	3/8"	10	5/30	22,94
107005003	1/2"	12	3/18	29,58
107007003	3/4"	15	2/12	36,32
107010003	1"	20	2/12	56,63
107012003	1"1/4	25	2/8	72,13
107015003	1"1/2	32	1/5	120,26
107020003	2"	40	1/5	170,65



NOTA: Disponibile anche, con maniglia nera
NOTE: Available, with black handle
ANMERKUNG: Erhältlich auch mit schwarzem Griff
NOTE: Disponible, avec poignée noire
ПРИМЕЧАНИЕ: Доступен также с чёрной ручкой

IVR 71 TRE VIE T



Valvola a sfera a tre vie a passaggio ridotto sfera forata a T - attacchi F/F/F

3-way valve with reduced bore and perforated ball type T - threaded ends F/F/F

3-Wege-Kugelhahn mit reduziertem Durchgang, Kugel mit T-Bohrung -IG/IG/IG

Vanne à boisseau sphérique à trois voies à passage réduit sphère percée en T - fixations F/F/F

Трехходовой шаровой кран с редуцированным проходом, сфера с «Т» образным отверстием - соединения В/В/В

Cod./Code	DN	Ø	□/田	€
107102003	1/4"	10	5/30	23,67
107103003	3/8"	10	5/30	22,94
107105003	1/2"	12	3/18	29,58
107107003	3/4"	15	2/12	36,32
107110003	1"	20	2/12	56,63
107112003	1"1/4	25	2/8	72,13
107115003	1"1/2	32	1/5	120,26
107120003	2"	40	1/5	170,65



NOTA: Disponibile anche, con maniglia nera
NOTE: Available, with black handle
ANMERKUNG: Erhältlich auch mit schwarzem Griff
NOTE: Disponible, avec poignée noire
ПРИМЕЧАНИЕ: Доступен также с чёрной ручкой



IVR 72 TRE VIE L

NEW



EAC

Valvola a sfera a tre vie deviatrice a passaggio ridotto sfera forata a L - attacchi F/F/F
3-way diverter ball valve with reduced bore - type L - F/F/F
3-Wege Ableitventil mit reduziertem Durchgang mit L-Bohrung - IG/IG/IG
Vanne déviatrice à boisseau sphérique à 3 voies avec passage réduit, percée en L - F/F/F
Трехходовой распределительный кран с редуцированным проходом, сфера с "L" образным отверстием, соединение В/В/В

Cod./Code	DN	Ø	□/田	€
107202001	1/4"	10	5/30	24,26
107203001	3/8"	10	5/30	24,26
107205001	1/2"	12	3/18	24,26
107207001	3/4"	15	2/12	28,09
107210001	1"	20	2/12	38,29
107212001	1"1/4	25	2/8	64,88
107215001	1"1/2	32	1/5	98,63
107220001	2"	40	1/5	140,25

IVR 73 TRE VIE T

NEW



EAC

Valvola a sfera a tre vie deviatrice a passaggio ridotto sfera forata a T - attacchi F/F/F
3-way diverter ball valve with reduced bore - type T - F/F/F
3-Wege Ableitventil mit reduziertem Durchgang mit T-Bohrung - IG/IG/IG
Vanne déviatrice à boisseau sphérique à 3 voies avec passage réduit, percée en T - F/F/F
Трехходовой распределительный кран с редуцированным проходом, сфера с "Т" образным отверстием, соединение В/В/В

Cod./Code	DN	Ø	□/田	€
107302001	1/4"	10	5/30	24,26
107303001	3/8"	10	5/30	24,26
107305001	1/2"	12	3/18	24,26
107307001	3/4"	15	2/12	28,09
107310001	1"	20	2/12	38,29
107312001	1"1/4	25	2/8	64,88
107315001	1"1/2	32	1/5	98,63
107320001	2"	40	1/5	140,25

IVR 63 VALVOLA YPSILON



EAC

Valvola a sfera a passaggio totale a Y - attacchi F/F/F
Full bore ball valve type Y - threaded ends F/F/F
Y-förmigem Kugelhahn, vollem Durchgang - IG/IG/IG
Vanne à boisseau sphérique à passage intégral en Y - fixations F/F/F
Полнопроходной шаровой кран тип "Y" - соединения В/В/В

Cod./Code	DN	Ø	□/田	€
106305001	1/2" x 3/8"	15	5/20	20,84
106307001	3/4" x 1/2"	15	5/20	19,17
106310001	1" x 3/4"	20	2/8	29,24
106312001	1"1/4 x 1"	20	2/8	27,50

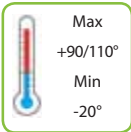

IVR VALVOLE ATTACCO POMPA

IVR 108



Valvola a sfera con filetto F e con calotta per attacco pompa e circolatori

Ball valve with F thread and loose nut for pump connection

Pumpen-Kugelhahn mit IG - Überwurfmutter

Vanne à boisseau sphérique avec écrou tournant pour pompe

Шаровой кран с внутренней резьбой и накидной гайкой для соединения с циркуляционным насосом



Cod./Code	DN	Ø	□/田	€
110810001	1" F x 1"1/2 F	18,5	100	8,25

IVR 109



Valvola a sfera con attacco tubo rame e calotta per attacco pompa e circolatori

Ball valve with copper connection and loose nut for pump connection

Pumpen-Kugelhahn mit Kompression-Anschluss für Kupferrohr und Überwurfmutter

Vanne à boisseau sphérique avec raccord à compression pour tube cuivre et écrou tournant pour pompe

Шаровой кран для насосов с соединением для медной трубы и накидной гайкой для соединения с насосом



Cod./Code	DN	Ø	□/田	€
110900221	22 x 1"1/2 F	18,5	100	8,00
110900281	28 x 1"1/2 F	18,5	100	9,04

IVR 380



Valvola a sfera con filetto F e con calotta per attacco pompa e circolatori

Ball valve with F thread and loose nut for pump connection

Pumpen-Kugelhahn - IG - Überwurfmutter

Vanne à boisseau sphérique avec écrou tournant pour pompe

Шаровой кран для насосов с соединением для медной трубы и накидной гайкой для соединения с циркуляционным насосом



Cod./Code	DN	Ø	□/田	€
138010002	1" F x 1"1/2 F	20	10/40	13,84

IVR 381



Valvola a sfera con filetto F e con calotta + ritegno per attacco pompa e circolatori
Ball valve with F thread and loose nut + anti-return for pump connection
Pumpenkugelhahn IG und Überwurfsmutter + Schwerkraftbremse für Pumpe und Zirkulatoren
Vanne à boisseau sphérique avec fixation F et écrou tournant + anti-retour pour fixation pompe et circulateurs
Шаровой кран с внутренней резьбой и накидной гайкой + обратный клапан для соединения с циркуляционным насосом



Cod./Code	DN	Ø	□/田	€
138110002	1" F x 1"1/2 F	20	10/40	15,05

IVR 382



Valvola a sfera con filetto F e con calotta + ritegno (disattivabile) per attacco pompa e circolatori
Ball valve with F thread and loose nut + anti-return (disactivable) for pump connection and circulators
Pumpenkugelhahn IG und Überwurfsmutter + abschaltbarer Schwerkraftbremse für Pumpe und Zirkulatoren
Vanne à boisseau sphérique avec fixation F et écrou tournant + anti-retour (désactivable) pour pompe et circulateurs
Шаровой кран с внутренней резьбой и накидной гайкой + обратный клапан (отключаемый) для соединения с циркуляционным насосом



Cod./Code	DN	Ø	□/田	€
138210002	1" F x 1"1/2 F	20	10/40	16,17

IVR 650 SARACINESCA PER POMPE



Valvola a saracinesca con attacco tubo rame e calotta per attacco pompa e circolatori
Gate valve with copper connection and loose nut for pump connection
Absperschieber für Pumpen - Anschlüsse für Kupferrohr
Vanne à passage direct avec raccord à compression pour tube cuivre et écrou tournant pour pompe
Шиберный клапан с соединением для медной трубы и накидной гайкой для соединения с циркуляционным насосом



Cod./Code	DN	Ø	□/田	€
165022001	22 x 1"1/2 F	50	50	9,67
165028001	28 x 1"1/2 F	50	50	12,61

IVR 395 C



Calotta in ottone nichelata per valvole IVR 395 e IVR 396
Nickel-plated loose nut for valves IVR 395 and IVR 396
Vernickelte Überwurfsmutter für Ventile IVR 395 und IVR 396
Écrou tournant nickelé pour les vannes IVR 395 et IVR 396
Гайка из никелированной латуни для кранов IVR 395 и IVR 396



Cod./Code	DN	Ø	□/田	€
228215100	1"1/2	8/64	8/64	2,56

IVR 392

NEW



Valvola a sfera in ottone con maniglia a T, attacchi F/F
Ball valve in brass with T handle, F/F
Kugelventil aus Messing mit T-Handgriff, IG/IG
Vanne à boisseau sphérique en laiton avec poignée en T, F/F
Шаровой кран из латуни с Т образной ручкой, соединения В/В

Cod./Code	DN	□/田	€
139205001	1/2"	20/100	9,19
139207001	3/4"	15/60	12,56
139210001	1"	12/48	22,31
139212001	1" 1/4	6/36	33,49
139215001	1" 1/2	6/24	45,98

IVR 393

NEW



Valvola a sfera in ottone con maniglia a T, attacchi M/F
Ball valve in brass with T handle, M/F
Kugelventil aus Messing mit T-Handgriff, AG/IG
Vanne à boisseau sphérique en laiton avec poignée en T, M/F
Шаровой кран из латуни с Т образной ручкой, соединения Н/В

Cod./Code	DN	□/田	€
139305001	1/2"	20/100	9,19
139307001	3/4"	15/60	12,56
139310001	1"	12/48	22,31
139312001	1" 1/4	6/36	33,49
139315001	1" 1/2	6/24	45,98

IVR 395

NEW



Valvola a sfera in ottone con maniglia a T, con attacco pompa
Ball valve in brass with T handle, with pump connection
Kugelventil aus Messing mit T-Handgriff und Pumpenverbindung
Vanne à boisseau sphérique en laiton avec poignée en T et fixation pour pompe
Шаровой кран из латуни с Т образной ручкой, с соединением для насоса

Cod./Code	DN	□/田	€
139510151	1" x 1" 1/2	8/64	20,89
139512151	1" 1/4 x 1" 1/2	8/64	22,61

IVR 396

NEW



Valvola a sfera in ottone con maniglia a T, con attacco pompa, con ritegno
Ball valve in brass with T handle, with pump connection and anti-return
Kugelventil aus Messing mit T-Handgriff, mit Pumpenverbindung und Schwerkraftbremse
Vanne à boisseau sphérique en laiton avec poignée en T, fixation pour pompe et anti-retour
Шаровой кран из латуни с Т образной ручкой, с соединением для насоса и обратным клапаном

Cod./Code	DN	□/田	€
139610151	1" x 1" 1/2	8/64	24,34
139612151	1" 1/4 x 1" 1/2	8/64	26,06



IVR IDRETTO

IVR 966



Rubinetto a sfera con portagomma
Bibcock with hose connection
"Garten-Wasserhahn" mit Schlauchanschluss
Robinet de puisage simple avec poignée plate
Поливочный кран с насадкой для шланга



Cod./Code	DN	Ø	□/田	€
196603001	3/8"	10	25/100	5,96
196605001	1/2"	15	25/100	6,30
196607001	3/4"	20	16/64	8,58
196610001	1"	25	8/48	15,18

IVR 966/A



Rubinetto a sfera con portagomma
Bibcock with hose connection
"Garten-Wasserhahn" mit Schlauchanschluss
Robinet de puisage simple avec poignée papillon
Поливочный кран с насадкой для шланга



Cod./Code	DN	Ø	□/田	€
196603002	3/8"	10	25/100	5,96
196605002	1/2"	15	25/100	6,30
196607002	3/4"	20	16/64	8,58
196610002	1"	25	8/48	15,18

IVR MIGNON

IVR 925 STAMPATA



Mini valvola mignon - attacchi F/F
Mini-valve mignon - threaded ends F/F
Kugelhahn Mignon - IG/IG - erhältlich mit schwarzem, rotem oder blauem Griff
Mini vanne mignon - fixations F/F
Мини шаровой кран "мигньон" - соединения В/В

EAC

Cod./Code	DN	Ø	□/田	€
192502001	1/4"	8	60/300	4,06
192503001	3/8"	8	60/300	3,51
192505001	1/2"	10	50/250	3,89

IVR 926 STAMPATA



Mini valvola mignon - attacchi M/F
Mini-valve mignon - threaded ends M/F
Kugelhahn Mignon - AG/IG - erhältlich mit schwarzem, rotem oder blauem Griff
Mini vanne mignon - fixations M/F
Мини шаровой кран "мигньон" - соединения Н/В

EAC

Cod./Code	DN	Ø	□/田	€
192602001	1/4"	8	60/300	3,21
192603001	3/8"	8	60/300	3,04
192605001	1/2"	10	50/250	3,72

IVR 927 BARRA



Mini valvola mignon - attacchi F/F
Mini-valve mignon - threaded ends F/F
Kugelhahn Mignon - IG/IG
Mini vanne mignon - fixations F/F
Шаровой кран типа "мигньон" - Соединения В/В

EAC

Cod./Code	DN	Ø	□/田	€
192701001	1/8"	6	60/300	3,89
192702001	1/4"	8	60/300	3,68
192703001	3/8"	8	60/300	3,38
192705001	1/2"	10	50/250	4,40
112707001	3/4"	13,5	30/180	8,45

IVR 928 BARRA



EAC

Mini valvola mignon - attacchi M/F
Mini-valve mignon - threaded ends M/F
Kugelhahn Mignon - AG/IG
Mini vanne mignon - fixations M/F
Мини шаровой кран "миньон" - соединения Н/В

Cod./Code	DN	Ø	□/田	€
192801001	1/8"	6	60/300	3,51
192802001	1/4"	8	60/300	3,21
192803001	3/8"	8	60/300	3,09
192805001	1/2"	10	50/250	4,57
112807001	3/4"	13,5	30/180	8,45

IVR 129



EAC

Mini valvola mignon - attacchi M/M
Mini-valve mignon - threaded ends M/M
Kugelhahn Mignon - AG/AG
Mini vanne mignon - fixations M/M
Мини шаровой кран "миньон" - соединения Н/Н

Cod./Code	DN	Ø	□/田	€
112901001	1/8"	6	60/300	7,05
112902001	1/4"	8	60/300	4,99
112903001	3/8"	8	60/300	4,91
112905001	1/2"	10	50/250	5,51

IVR SCARICO CALDAIA

IVR 904



EAC

Rubinetto per scarico caldaia completo di tappo - attacchi M - portagomma
Boiler blow-off valve with hose connection and cap - M threaded
KFE-Hahn (Kessel Füll- und Entleerungshahn) mit Deckel - AG - Schlauchanschluss
Robinet d'évacuation chaudière avec bouchon - fixations M - porte tuyau souple - Poignée noire
Сливной кран для котла в комплекте с насадкой для шланга и заглушкой - резьбовое соединение H

Cod./Code	DN	Ø	□/田	€
190403001	3/8" x 3/4"	8	40/160	4,78
190405001	1/2" x 3/4"	10	40/160	5,12
190407001	3/4" x 1"	15	20/100	7,74

IVR 905



EAC

Rubinetto per scarico caldaia completo di tappo - attacchi M - portagomma
Boiler blow-off valve with hose connection and cap - M threaded
KFE-Hahn (Kessel Füll- und Entleerungshahn) mit Deckel - AG - Schlauchanschluss
Robinet d'évacuation chaudière avec bouchon - fixations M - porte tuyau souple - poignée rouge et joint étancheité
Сливной кран для котла в комплекте с насадкой для шланга и заглушкой - резьбовое соединение H

Cod./Code	DN	Ø	□/田	€
190505001	1/2" x 3/4"	10	20/100	6,49

IVR 103 SCARICO CALDAIA PESANTE



EAC

Rubinetto per scarico caldaia serie pesante con quadro di manovra e cappuccio con chiave incorporata - attacco F

Boiler blow off valve heavy type with hose connection and cap. F Threaded
KFE-Hahn (Kessel Füll-und Entleerungshahn) - schwere Ausführung - mit Schalttafel und Deckel - IG - Schlauchanschluss - mit integriertem Schlüssel
Robinet d'évacuation chaudière série lourde avec tableau de manoeuvre et capuchon à clé intégrée - fixation F
Усиленный сливной кран для котла, с квадратной управляющей головкой и крышкой со встроенным ключом - резьбовое соединение B

Cod./Code	DN	Ø	□/田	€
110305001	1/2" x 3/4"	10	10/60	10,52
110307001	3/4" x 1"	15	10/60	16,12
110310001	1"	25	10/60	24,46

IVR 105 SCARICO CALDAIA PESANTE



EAC

Rubinetto per scarico caldaia serie pesante con quadro di manovra e cappuccio con chiave incorporata - attacco M

Boiler blow off valve heavy type with hose connection and cap. M Threaded
KFE-Hahn (Kessel Füll-und Entleerungshahn) - schwere Ausführung - mit Schalttafel und Deckel - AG - Schlauchanschluss - mit integriertem Schlüssel
Robinet d'évacuation chaudière série lourde avec tableau de manoeuvre et capuchon à clé intégrée - fixation M
Усиленный сливной кран для котла, с квадратной управляющей головкой и крышкой со встроенным ключом - резьбовое соединение H

Cod./Code	DN	Ø	□/田	€
110505001	1/2" x 3/4"	10	10/60	10,89
110507001	3/4" x 1"	15	10/60	16,47
110510001	1"	25	10/60	25,40

IVR RUBINETTI

IVR 136 RUBINETTO LAVATRICE



Rubinetto per lavatrice - attacchi M/M
Washing machine valve - threaded ends M/M
Wasserhahn für Waschmaschine - AG/AG
Robinet machine à laver - fixations M/M
Кран для стиральной машины - соединения Н/Н

EAC

Cod./Code	DN	Ø	□/田	€
113603001	3/8" x 3/4"	9	20/120	6,19
113605001	1/2" x 1/2"	9	20/100	6,41
113607001	1/2" x 3/4"	9	20/100	6,68

IVR 136/A RUBINETTO LAVATRICE



Rubinetto per lavatrice - attacchi M/M
Washing machine valve - threaded ends M/M
Wasserhahn für Waschmaschine - AG/AG
Robinet machine à laver - fixations M/M
Кран для стиральной машины - соединения Н/Н

EAC

Cod./Code	DN	Ø	□/田	€
113603002	3/8" x 3/4"	9	20/120	6,41
113605002	1/2" x 1/2"	9	20/100	6,60
113607002	1/2" x 3/4"	9	20/100	6,90

IVR 297 RUBINETTO SOTTOLAVABO



Rubinetto sottolavabo con rosone, tipo corto - attacchi M/M
Angle ball valve with rosette, short type - threaded ends M/M
Eckregulierventil mit Rosette, kurze Ausführung - AG/AG
Robinet sous lavabo avec rosace, type court - fixations M/M
Кран укороченного типа с декоративной накладкой под умывальник - соединения Н/Н

EAC

Cod./Code	Misura/Size	□/田	€
129703051	3/8" x 1/2" L. 82,5 mm	1/90	3,47
129705051	1/2" x 1/2" L. 82,5 mm	2/180	3,51

IVR INCASSO

IVR 130 INCASSO A LEVA



Valvola a sfera per incasso a passaggio totale con leva - attacchi F/F
Full bore ball valve with handle and rosette for in-wall installations. Threaded ends F/F
Unterputzkugelhahn mit vollem Durchgang - Handhebel - IG/IG
Vanne à boisseau sphérique avec poignée et rosette pour installation dans le mur. Fixations F/F
Полнопроходной шаровой кран с ручкой-флажком, встраиваемый в стену - соединения В/В



Cod./Code	DN	Ø	□/田	€
113005001	1/2"	15	8/48	16,79
113007001	3/4"	20	6/36	23,52
113010001	1"	25	5/30	32,78

IVR 134 INCASSO A MANIGLIA



Valvola a sfera per incasso a passaggio totale con manopola - attacchi F/F
Full bore ball valve with handle and rosette for in-wall installations. Threaded ends F/F
Unterputzkugelhahn mit vollem Durchgang - Drehknopf - IG/IG
Vanne à boisseau sphérique avec poignée et rosette pour installation dans le mur. Fixations F/F
Полнопроходной шаровой кран с поворотной ручкой, встраиваемый в стену - соединения В/В



Cod./Code	DN	Ø	□/田	€
113405001	1/2"	15	6/36	19,62
113407001	3/4"	20	5/30	26,35
113410001	1"	25	4/24	35,57

IVR 135 INCASSO A CAPPUCCIO



Valvola a sfera per incasso a passaggio totale con cappuccio - attacchi F/F
Full bore ball valve with cap for in-wall installations. Threaded ends F/F
Unterputzkugelhahn mit vollem Durchgang - Kappe - IG/IG
Vanne a boisseau sphérique avec capuchon pour installation dans le mur. Fixations F/F
Полнопроходной шаровой кран с конусным колпачком, встраиваемый в стену - соединения В/В



Cod./Code	DN	Ø	□/田	€
113505001	1/2"	15	10/60	17,53
113507001	3/4"	20	5/30	24,26
113510001	1"	25	5/30	33,52

IVR VALVOLAME

IVR 993 TG RITEGNO



Valvola di ritegno a clapet con tenuta gomma
Swing check valve with rubber seat
Rückschlagventil mit Klappe mit Gummidichtung
Vanne à clapet avec tenue en gomme
Обратный клапан clapet с резиновым уплотнением

Cod./Code	Ø	□/田	€
199305100	1/2"	18/144	5,62
199307100	3/4"	10/120	7,91
199310100	1"	8/72	11,37
199312100	1 1/4"	6/36	18,31
199315100	1 1/2"	4/24	27,69
199320100	2"	3/18	40,67
199325100	2 1/2"	12	60,88
199330100	3"	8	94,20
199340100	4"	4	169,84



IVR 993 TM RITEGNO



Valvola di ritegno a clapet con tenuta metallica
Swing check valve with metallic seat
Rückschlagventil mit Klappe mit Metaldichtung
Vanne à clapet avec tenue en métal
Обратный клапан clapet с металлическим уплотнением

Cod./Code	Ø	□/田	€
199305001	1/2"	18/144	5,62
199307001	3/4"	10/120	7,91
199310001	1"	8/72	11,37
199312001	1 1/4"	6/36	18,31
199315001	1 1/2"	4/24	27,69
199320001	2"	3/18	40,67
199325001	2 1/2"	12	60,88
199330001	3"	8	94,20
199340001	4"	4	169,84



IVR 994 FONDO



Valvola di fondo
Foot valve
Fussventil
Crépine vertical
Донный клапан

Cod./Code	DN	□/田	€
199405001	1/2"	15/180	5,16
199407001	3/4"	18/108	6,72
199410001	1"	18/108	8,20
199412001	1 1/4"	8/48	13,61
199415001	1 1/2"	4/24	18,31
199420001	2"	3/18	28,24
199425001	2 1/2"	16	39,15
199430001	3"	12	61,47
199440001	4"	5	117,88



IVR 90 FONDO

NEW



Valvola di fondo tubolare
Cylindrical foot valve
Zylinderfussventil
Crépine vertical cylindrique
Трубчатый донный клапан

Cod./Code	DN	□/⊞	€
109007001	3/4"	40	11,30
109010001	1"	20	14,25
109012001	1"1/4	20	20,95
109015001	1"1/2	10	25,20
109020001	2"	8	35,87
109025001	2"1/2	1	66,94
109030001	3"	1	103,52
109040001	4"	1	139,28

IVR 98 FILTRO



Filtro inox con raccordo in ottone
Stainless steel mesh filter with brass connection
Nirostahlfiter mit Messing-Gewinde
Filtre inox avec raccord en laiton
Фильтр из нержавеющей стали с латунным соединением

Cod./Code	DN	□/⊞	€
109803001	3/8"	50	3,29
109805001	1/2"	35/210	3,41
109807001	3/4"	20/120	3,80
109810001	1"	25/100	4,44
109812001	1"1/4	20/120	8,75
109815001	1"1/2	10/60	10,31
109820001	2"	6/36	15,80
109825001	2"1/2	20	25,48
109830001	3"	10	30,33
109840001	4"	6	42,77

EAC

IVR 995 L FILTRO



Filtro inox con raccordo in nylon
Stainless steel mesh filter with nylon connection
Nirostahlfiter mit Nylon-Gewinde
Crépine seule
Фильтр из нержавеющей стали с соединением из нейлона

Cod./Code	DN	□/⊞	€
199505001	1/2"	18/324	0,57
199507001	3/4"	20/240	0,79
199510001	1"	12/144	1,06
199512001	1"1/4	15/90	1,37
199515001	1"1/2	8/48	1,54
199520001	2"	3/18	1,99
199525001	2"1/2	24	3,66
199530001	3"	18	4,41
199540001	4"	4	6,26

EAC

IVR 999 H RITEGNO



Valvola di ritegno tipo pesante con otturatore in acciaio inox
Check valve heavy type with inox shutter
Rückschlagventil, schwere Ausführung, mit Edelstahlklappe
Clapet de non retour avec obturateur inox
Усиленный обратный клапан с затвором из нержавеющей стали

Cod./Code	DN	□/⊞	€
199903100	3/8"	20/120	5,67
199905100	1/2"	20/120	6,17
199907100	3/4"	12/96	8,84
199910100	1"	15/60	13,61
199912100	1"1/4	8/40	20,84
199915100	1"1/2	6/30	28,50
199920100	2"	3/18	42,41
199925100	2"1/2	6	91,53
199930100	3"	4	139,90
199940100	4"	3	209,83



IVR 999 L RITEGNO



Valvola di ritegno con otturatore in nylon
Check valve with nylon shutter
Rückschlagventil, schwere Ausführung, mit Edelstahlklappe
Clapet de non retour avec obturateur en nylon
Обратный клапан с затвором из нейлона

Cod./Code	DN	□/⊞	€
199903001	3/8"	20/240	3,38
199905001	1/2"	20/120	3,81
199907001	3/4"	15/150	5,33
199910001	1"	12/96	7,95
199912001	1"1/4	6/72	11,63
199915001	1"1/2	8/48	16,40
199920001	2"	3/18	23,21
199925001	2"1/2	16	46,55
199930001	3"	12	62,32
199940001	4"	4	109,04



IVR 923 RITEGNO



Valvola di ritegno con filtro inox incorporato
Check valve with built - in filter
Rückschlagventil mit eingebautem Edelstahlfilter
Vanne de retenue avec filtre inox intégré
Обратный клапан с сетчатым фильтром из нержавеющей стали

Cod./Code	DN	□/⊞	€
192305001	1/2"	20/120	2,75
192307001	3/4"	18/108	3,89
192310001	1"	15/90	5,24
192312001	1"1/4	3/36	7,23
192315001	1"1/2	3/36	10,91
192320001	2"	3/12	16,07
192325001	2"1/2	12	32,60
192330001	3"	8	42,45
192340001	4"	5	62,07



IVR 924 RACCOGLITORE DI IMPURITÀ



Raccoglitore di impurità a Y, filtro in acciaio inox AISI 304 - attacchi F/F

Y strainer with mesh in inox AISI 304 - threaded ends F/F

Y- förmigem Schmutzfänger aus Messing mit Filter aus rostfreiem Edelstahl AISI 304 - IG

Raccord filtre à tamis incliné en Y avec filtre en inox AISI 304 - fixations F/F

Латунный фильтр "Y" образный из нержавеющей стали AISI 304 - соединения В/В

Cod./Code	DN	□/⊕	€
192402001	1/4"	5/200	3,09
192403001	3/8"	6/120	2,62
192405001	1/2"	20/180	4,52
192407001	3/4"	20/120	6,89
192410001	1"	15/90	9,89
192412001	1"1/4	6/36	19,49
192415001	1"1/2	2/24	23,68
192420001	2"	2/12	41,39
192425001	2"1/2	10	89,80
192430001	3"	8	104,39
192440001	4"	4	209,71



IVR SARACINESCHE

IVR 140



EAC

Saracinesca PN 20 - attacchi F/F
Gate valve PN 20 - threaded ends F/F
Muffen-Absperrschieber PN 20 - IG/IG
Vanne à passage direct PN 20 - fixations F/F
Шиберный клапан PN 20 - Соединения В/В

Cod./Code	DN	□/⊞	€
114002001	1/4"	20/120	7,11
114003001	3/8"	20/120	7,11
114005001	1/2"	20/120	9,08
114007001	3/4"	10/60	12,60
114010001	1"	10/60	17,51
114012001	1"1/4	10/60	25,31
114015001	1"1/2	5/30	33,45
114020001	2"	5/25	48,83
114025001	2"1/2	10	67,35
114030001	3"	5	83,59
114040001	4"	4	155,55

IVR 605



EAC

Saracinesca PN 16 - attacchi F/F
Gate valve PN 16 - threaded ends F/F
Muffen-Absperrschieber PN 16 - IG/IG
Vanne à passage direct PN 16 - fixations F/F
Шиберный клапан PN 16 - Соединения В/В

Cod./Code	DN	□/⊞	€
160502010	1/4"	20/120	6,98
160503010	3/8"	20/120	7,58
160505010	1/2"	20/80	6,83
160507010	3/4"	20/80	8,61
160510010	1"	12/48	12,05
160512010	1"1/4	12/48	16,10
160515010	1"1/2	8/32	23,85
160520010	2"	2/8	34,18
160525001	2"1/2	2/8	50,51
160530001	3"	10	66,22
160540001	4"	10	124,53
160550010	5"	4	279,56
160560010	6"	2	367,50

IVR 600



EAC

Saracinesca PN 10 - attacchi F/F
Gate valve PN 10 - threaded ends F/F
Muffen-Absperrschieber PN 10 - IG/IG
Vanne à passage direct PN 10 - fixations F/F
Шиберный клапан PN 10 - Соединения В/В

Cod./Code	DN	□/⊞	€
160005333	1/2"	20/80	5,96
160007333	3/4"	20/80	6,99
160010333	1"	15/60	8,94
160012333	1"1/4	10/40	12,92
160015333	1"1/2	12/48	16,47
160020333	2"	3/12	27,90

IVR 620 SARACINESCA BS 5154



Saracinesca BS 5154 - Attacchi tubo rame compressione - (a richiesta: attacchi per tubo rame irlandese)
Gate valve BS 5154 with compression ends for copper pipe - (Irish pipe connections available on request)
Muffen-Absperrschieber BS 5154 - Kompressionsanschluss für Kupferrohr - (auf Anfrage: Anschlüsse für irländisches Kupferrohr)
Vanne à passage direct BS 5154 - Fixations tube cuivre compression - (sur demande: fixations pour tube en cuivre irlandais)
Шибберный клапан BS 5154 - с компрессионными соединениями для медной трубы - (под заказ: соединения для ирландской медной трубы)

ERC

Cod./Code	DN	□/田	€
162015001	15	100	7,59
162022001	22	50	10,57
162028001	28	50	14,38

IVR 650 SARACINESCA PER POMPE



Saracinesca per pompe - attacchi tubo rame
Pump brass gate valve for copper pipe
Muffen-Absperrschieber für Pumpen - Anschlüsse für Kupferrohr
Vanne à passage direct pour pompe - fixations tube en cuivre
Шибберный клапан для насосов - для медной трубы

SU RICHIESTA
ON DEMAND

LOTTO MINIMO
MINIMUM BATCH

ERC

Cod./Code	DN	□/田	€
165022001	22	50	9,67
165028001	28	50	12,61

IVR 607 NPT

NEW



Saracinesca PN16 - volantino in acciaio - attacchi F/F NPT
Gate valve PN16 - handle in steel - F/F NPT
Absperrventil PN16 - Handrad aus Stahl - IG/IG NPT
Vanne à opercule PN16 - volant d'acier - F/F NPT
Шибберный клапан PN16 - со стальным маховиком - соединения В/В NPT

ERC

LOTTO MINIMO
MINIMUM BATCH

SU RICHIESTA
ON DEMAND

Cod./Code	DN	□/田	€
160705001	1/2"	20/80	7,02
160707001	3/4"	20/80	8,60
160710001	1"	12/48	12,21
160712001	1"1/4	12/48	16,26
160715001	1"1/2	8/32	24,04
160720001	2"	2/8	34,42

IVR RIDUTTORE DI PRESSIONE

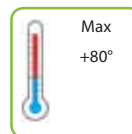
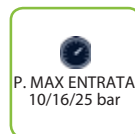

IVR 302 RIDUTTORE DI PRESSIONE COMPACT



Riduttore di pressione in ottone nichelato - attacchi F/F
Pressure reducing valve nickel-plated. F/F threaded ends
Druckminderer aus vernickeltem Messing - IG/IG
Réducteur de pression F/F en laiton nickelé - Taraudage F/F
Редуктор давления из никелированной латуни. Соединения В/В



Cod./Code	DN	□/田	€
130205100	1/2"	1/50	16,73

IVR 304 RIDUTTORE DI PRESSIONE MINI



Riduttore di pressione in ottone nichelato - attacchi F/F - con attacco manometro 1/4"
Pressure reducing valve nickel-plated - threaded ends F/F - with pressure gauge connection 1/4"
Druckminderer aus vernickeltem Messing - IG/IG - mit Manometeranschluss 1/4"
Réducteur de pression en laiton nickelé - fixations F/F - avec fixation manomètre 1/4"
Редуктор давления из никелированной латуни - соединения В/В - с соединением для манометра 1/4"



Cod./Code	DN	□/田	€
130403001	3/8"	1/50	16,69
130405001	1/2"	1/50	17,85
130407001	3/4"	1/50	18,26

Per manometri vedi pagina 215
For pressure gauges see page 215

IVR 305 RIDUTTORE DI PRESSIONE



Riduttore di pressione in ottone nichelato - attacchi F/F - con attacco manometro 1/4"
Pressure reducing valve nickel-plated - threaded ends F/F - with pressure gauge connection 1/4"
Druckminderer aus vernickeltem Messing - IG/IG - mit Manometeranschluss 1/4"
Réducteur de pression en laiton nickelé - fixations F/F - avec fixation manomètre 1/4"
Редуктор давления из никелированной латуни - соединения В/В - с соединением для манометра 1/4"



Cod./Code	DN	□/田	€
130505001	1/2"	1/15	30,86
130507001	3/4"	1/15	33,64
130510001	1"	1/10	53,85
130512001	1"1/4	1/5	87,15
130515001	1"1/2	1/5	91,88
130520001	2"	1/4	149,70
130525001	2"1/2	1/4	233,89
130530001	3"	1	278,03

Per manometri vedi pagina 215
For pressure gauges see page 215

IVR 303 RIDUTTORE DI PRESSIONE



Riduttore di pressione con sede in acciaio inox - bocchettoni F/F - con attacco manometro 1/4"
Pressure reducing valve with stainless steel seat - tail piece F/F - with pressure gauge connection 1/4"
Druckminderer mit Sitz aus Edelstahl - IG/IG - mit Manometeranschluss 1/4"
Réducteur de pression avec siège en acier inox - fixations F/F - avec fixation manomètre 1/4"
Редуктор давления со седлом из нержавеющей стали, соединения с накидной гайкой В/В - с соединением для манометра 1/4"

Cod./Code	DN	□/⊕	€
130305001	1/2"	1/15	41,03
130307001	3/4"	1/10	63,60
130310001	1"	1/10	71,10
130312001	1"1/4	1/5	132,30
130315001	1"1/2	1/6	133,13
130320001	2"	1/4	208,99



Per manometri vedi pagina 215
For pressure gauges see page 215

IVR 300 RIDUTTORE DI PRESSIONE



Riduttore di pressione con sede in acciaio inox - bocchettoni M/M - con attacco manometro 1/4"
Pressure reducing valve with stainless steel seat - tail piece M/M - with pressure gauge connection 1/4"
Druckminderer mit Sitz aus Edelstahl - AG/AG - mit Manometeranschluss 1/4"
Réducteur de pression avec siège en acier inox - fixations M/M - avec fixation manomètre 1/4"
Редуктор давления со седлом из нержавеющей стали - соединения с накидной гайкой Н/Н - с соединением для манометра 1/4"

Cod./Code	DN	□/⊕	€
130005001	1/2"	1/18	37,24
130007001	3/4"	1/15	41,78
130010001	1"	1/10	66,15
130012001	1"1/4	1/6	110,78
130015001	1"1/2	1/5	121,69
130020001	2"	1/4	202,01



Per manometri vedi pagina 215
For pressure gauges see page 215

IVR 306 COLPO D'ARIETE



Ammortizzatore del colpo d'ariete
Water hammer arrestor
Wasserrückschlagdämpfer
Amortisseur du coup de bélier
Амортизатор гидравлического удара



Cod./Code	DN	□/⊕	€
130605001	1/2" nichelata	10/40	26,36
130605002	1/2" gialla	10/40	23,33

FILTRO AUTOPULENTE - SELF-CLEANING FILTER

IVR 398

NEW



Filtro autopulente F/F
Self-cleaning filter F/F
Selbstreinigender Filter IG/IG
Filtre autonettoyant F/F
Самоочищающийся фильтр В/В

Cod./Code	DN	□/田	€
139805001	1/2"	1	71,25
139807001	3/4"	1	71,25
139810001	1"	1	93,38
139812001	1" 1/4	1	93,38
139815001	1" 1/2	1	147,00
139820001	2"	1	147,00

Per manometri vedi pagina 215
For pressure gauges see page 215

IVR 399

NEW



Filtro autopulente F/F con manometri
Self-cleaning filter F/F with pressure gauges
Selbstreinigender Filter IG/IG mit Manometern
Filtre autonettoyant F/F avec manomètres
Самоочищающийся фильтр В/В с манометрами

Cod./Code	DN	□/田	€
139905001	1/2"	1	87,75
139907001	3/4"	1	87,75
139910001	1"	1	109,88
139912001	1" 1/4	1	109,88
139915001	1" 1/2	1	163,50
139920001	2"	1	163,50

Per manometri vedi pagina 215
For pressure gauges see page 215

IVR RACCORDERIA

IVR 312 P RACCORDO SEDE PIANA



EAC

Raccordo diritto in due pezzi a sede piana con guarnizione
2 pieces union end with gasket
Anschlussstück mit gerader Verschraubung, zweiteilig, mit Flachsitz und Dichtung
Raccord droit en deux pièces à siège plat avec joint
Двухсоставной прямой соединительный фитинг с плоским седлом и уплотнением

Cod./Code	DN	□/⊞	€
131205002	1/2" x 3/4"	50/200	2,27
131207002	3/4" x 1"	50/200	3,02
131210002	1" x 1"1/4	20/80	4,89
131212002	1"1/4 x 1"1/2	50	6,33
131215002	1"1/2 x 2"	70	15,64
131220002	2" x 2"1/2	30	31,61

IVR 312 P/N RACCORDO SEDE PIANA NICHELATO

NEW



EAC

Raccordo diritto in due pezzi a sede piana con guarnizione, nichelato
Nickel-plated 2-piece straight union end with flat seat with gasket
Vernickeltes zweiteiliges Anschlussstück mit gerader Verschraubung und flachem Sitz mit Dichtung
Raccord droit nickelé en deux pièces à siège plate avec joint
Никелированный двухсоставной прямой соединительный фитинг с плоским седлом и уплотнением

Cod./Code	DN	□/⊞	€
131205001	1/2" x 3/4"	50/200	2,33
131207001	3/4" x 1"	50/200	3,23
131210001	1" x 1"1/4	20/80	5,03
131212001	1"1/4 x 1"1/2	50	6,52
131215001	1"1/2 x 2"	70	16,29
131220001	2" x 2"1/2	30	66,11

IVR 310 P RACCORDO SEDE PIANA



EAC

Raccordo diritto in tre pezzi a sede piana con guarnizione
3 pieces union end with gasket
Anschlussstück mit gerader Verschraubung, dreiteilig, mit Flachsitz und Dichtung
Raccord droit en trois pièces à siège plat avec joint
Трехсоставной прямой соединительный фитинг с плоским седлом и уплотнением

Cod./Code	DN	□/⊞	€
131003001	3/8"	20/120	3,06
131005001	1/2"	20/120	3,45
131007001	3/4"	20/80	4,81
131010001	1"	20/80	7,92
131012001	1"1/4	10/40	10,44
131015001	1"1/2	50	23,87
131020001	2"	25	42,89

IVR 310 P/N RACCORDO SEDE PIANA NICHELATO

NEW



EAC

Raccordo diritto in tre pezzi a sede piana con guarnizione, nichelato

Nickel-plated 3-piece straight union end with flat seat with gasket

Vernickeltes dreiteiliges Anschlussstück mit gerader Verschraubung und flachem Sitz mit Dichtung

Raccord droit nickelé en trois pièces à siège plate avec joint

Никелированный трёхсоставной прямой соединительный фитинг с плоским седлом и уплотнением

Cod./Code	DN	□/⊞	€
131003002	3/8"	20/120	3,23
131005002	1/2"	20/120	3,54
131007002	3/4"	20/80	4,95
131010002	1"	20/80	8,15
131012002	1"1/4	10/40	10,91
131015002	1"1/2	50	24,99
131020002	2"	25	44,83

IVR 315 P RACCORDO SEDE PIANA



EAC

Raccordo curvo in tre pezzi a sede piana con guarnizione

90-degree 3 pieces union end with gasket

Anschlussstück mit gebogener Verschraubung, dreiteilig, mit Flachsitz und Dichtung

Raccord courbe en trois pièces à siège plat avec joint

Трёхсоставной угловой соединительный фитинг с плоским седлом и уплотнением

Cod./Code	DN	□/⊞	€
131503001	3/8"	200	3,71
131505001	1/2"	200	5,16
131507001	3/4"	100	8,22
131510001	1"	50	14,67
131512001	1"1/4	50	20,00
131515001	1"1/2	25	32,73
131520001	2"	15	59,99

IVR 315 P/N RACCORDO SEDE PIANA NICHELATO

NEW



EAC

Raccordo curvo in tre pezzi a sede piana con guarnizione, nichelato

Nickel-plated 3-piece straight union end with flat seat with gasket

Vernickeltes dreiteiliges Anschlussstück mit Eckverschraubung und flachem Sitz mit Dichtung

Raccord équerre nickelé en trois pièces à siège plate avec joint

Никелированный трёхсоставной угловой соединительный фитинг с плоским седлом и уплотнением

Cod./Code	DN	□/⊞	€
131503002	3/8"	200	3,87
131505002	1/2"	200	5,32
131507002	3/4"	100	8,55
131510002	1"	50	15,48
131512002	1"1/4	50	48,38
131515002	1"1/2	25	34,02
131520002	2"	15	63,53

IVR 310 C RACCORDO SEDE CONICA



Raccordo diritto in tre pezzi a sede conica con o-ring
3 pieces union end conical seat with o-ring
Anschlussstück mit gerader Verschraubung, dreiteilig, mit Kegelsitz und O-Ring
Raccord droit en trois pièces à siège conique avec o-ring
Трёхсоставной прямой соединительный фитинг с коническим седлом и уплотняющим О-кольцом

Cod./Code	DN	□/田	€
131003010	3/8"	100	3,06
131005010	1/2"	50/200	3,51
131007010	3/4"	25/100	5,00
131010010	1"	20/80	8,21
131012010	1"1/4	10/40	10,87
131015010	1"1/2	50	23,87
131020010	2"	25	42,89

EAC

IVR 310 C/N RACCORDO SEDE CONICA NICHELATO

NEW



Raccordo diritto in tre pezzi a sede conica con o-ring, nichelato
Nickel-plated 3-piece straight union end with conical seat and O-ring
Vernickeltes dreiteiliges Anschlussstück mit gerader Verschraubung und Kegelsitz mit O-Ring
Raccord droit nickelé en trois pièces à siège conique avec joint
Никелированный трёхсоставной прямой соединительный фитинг с коническим седлом и уплотняющим О-кольцом

Cod./Code	DN	□/田	€
131003012	3/8"	100	3,23
131005012	1/2"	50/200	3,65
131007012	3/4"	25/100	5,17
131010012	1"	20/80	8,43
131012012	1"1/4	10/40	11,34
131015012	1"1/2	50	58,13
131020012	2"	25	44,83

EAC

IVR 315 C RACCORDO SEDE CONICA



Raccordo curvo in tre pezzi a sede conica con o-ring
90-degree 3 pieces union end conical seat with o-ring
Anschlussstück mit gebogener Verschraubung, dreiteilig, mit Kegelsitz und O-Ring
Raccord courbe en trois pièces à siège conique avec o-ring
Трёхсоставной угловой соединительный фитинг с коническим седлом и уплотняющим О-кольцом

Cod./Code	DN	□/田	€
131503010	3/8"	200	3,71
131505010	1/2"	200	5,16
131507010	3/4"	100	8,22
131510010	1"	75	14,67
131512010	1"1/4	50	20,00
131515010	1"1/2	25	32,73
131520010	2"	15	59,99

EAC

IVR 315 C/N RACCORDO SEDE CONICA NICHELATO

NEW



Raccordo curvo in tre pezzi a sede conica con o-ring, nichelato
Nickel-plated 90-degree 3-piece straight union end with conical seat and O-ring
Vernickeltes dreiteiliges Anschlussstück mit Eckverschraubung und Kegelsitz mit O-Ring
Raccord équerre nickelé en trois pièces à siège conique avec o-ring
Никелированный трёхсоставной угловой соединительный фитинг с коническим седлом и уплотняющим O-кольцом

EAC

Cod./Code	DN	□/⊞	€
131503012	3/8"	200	3,87
131505012	1/2"	200	5,32
131507012	3/4"	100	8,55
131510012	1"	75	15,48
131512012	1"1/4	50	20,80
131515012	1"1/2	25	34,02
131520012	2"	15	63,53

IVR 318 RACCORDO PER CONTATORI ACQUA



Coppia di raccordi per contatori acqua completi di guarnizioni
Couple of union connections for water meters fitted with washers
Zwei Anschlüsse für Wasserzähler mit Dichtungen
Couple de raccords pour compteurs d'eau
Пара фитингов для счетчиков воды в комплекте с прокладками

EAC

Cod./Code	DN	□/⊞	€
131805001	1/2" x 3/4"	10/60	5,06
131807001	3/4" x 1"	100	7,13
131810001	1" x 1"1/4	75	17,63
131812001	1"1/4 x 1"1/2	50	21,75
131815001	1"1/2 x 2"	25	31,88
131820001	2" x 2"1/2	15	58,13

IVR 320 RACCORDO



Raccordo a cinque vie tipo corto
Five ways short connection
5-Wege-Anschlussstück, kurze Ausführung
Raccord à cinq voies type court
Укороченный соединительный фитинг на пять выходов

EAC

Cod./Code	DN	H	□/⊞	€
132010001	1"	72	100	9,03

IVR 321 RACCORDO



Raccordo a cinque vie tipo lungo
Five ways long connection
5-Wege-Anschlussstück, lange Ausführung
Raccord à cinq voies type long
Удлиненный соединительный фитинг на пять выходов

EAC

Cod./Code	DN	H	□/⊞	€
132110001	1"	95	100	9,49

IVR 42/43 R QUADRO DI MANOVRA



Quadro manovra 28 mm per IVR 42- 43
Square cap 28 mm for IVR 42 - 43
Schalttafel 28 mm für IVR 42- 43
Tableau de manoeuvre 28 mm pour IVR 42 - 43
Квадратный хвостовик 28 мм для IVR 42 - 43

Cod./Code	Misura/Size	DN	□/田	€
705010001	1a MIS	1/2" - 3/4"	10/120	5,11
705020001	2a MIS	1" - 1"1/4	10/120	5,10
705030001	3a MIS	1"1/2 - 2"	10/120	6,37

IVR 966 R GIRELLO PER IDRETTO



Girello completo per Idretto IVR 966
Hose union for bibcock for Idretto IVR 966
Schlauchanschluss für Idretto IVR 966
Jonction pour Idretto IVR 966
Насадка для подключения шланга - для IDRETTO IVR 966

Cod./Code	Misura/Size	□/田	€
338003150	3/8"	1	0,80
338005150	1/2"	1	0,80
338007150	3/4"	1	1,10
338010150	1"	1	1,94

IVR 130 R PROLUNGA E SET RICAMBI

Prolunga e set ricambi parti cromate per valvole incasso
Stem extensions and set of chrome-plated spare parts for ball valves for in-wall installations
Verlängerung und Ersatzteileset für verchromte Unterputzventilteile
Rallonge et kit de pièces de rechange chromées pour vannes à encastrer
Насадка удлиняющая и набор хромированных запасных частей для встраиваемых клапанов



Cod./Code	Misura/Size	Per articoli/For items/Für Artikel/pour article /Для изделия	□/田	€
109799001	1/2"-3/4"-1"	Prolunga / Stem - 130-134-135	1	3,75



Cod./Code	Misura/Size	Per articoli/For items/Für Artikel/pour article /Для изделия	□/田	€
911300501	1/2"	130	1	5,88
911300701	3/4"	130	1	5,88
911301001	1"	130	1	5,88



Cod./Code	Misura/Size	Per articoli/For items/Für Artikel/pour article /Для изделия	□/田	€
911340501	1/2"	134	1	7,94
911340701	3/4"	134	1	7,94
911341001	1"	134	1	7,94



Cod./Code	Misura/Size	Per articoli/For items/Für Artikel/pour article /Для изделия	□/田	€
911350501	1/2"	135	1	5,48
911350701	3/4"	135	1	5,48
911351001	1"	135	1	5,48

IVR 359 MANOMETRO



Manometro Ø 50 - 63 mm - attacco posteriore per IVR 300 - 303 - 305
Axial pressure gauge Ø 50 - 63 mm - back connection for IVR 300 - 303 - 305
Manometer Ø 50 - 63 mm - Anschluss hinten, für IVR 300 - 303 - 305
Manomètre Ø 50 - 63 mm - fixation arrière pour IVR 300 - 303 - 305
Манометр с осевым подключением Ø 50 - 63 mm - для IVR 300 - 303 - 305

Cod./Code	DN	Ø	□/田	€
135902116	1/4"	Ø 50 - scale 0-16 bar	100	7,28
135902206	1/4"	Ø 63 - scale 0-6 bar	100	8,25
135902210	1/4"	Ø 63 - scale 0-10 bar	100	8,25
135902216	1/4"	Ø 63 - scale 0-16 bar	100	8,25

IVR 358 MANOMETRO RADIALE ALIMENTAZIONE



Manometro diametro 50 - 63 mm - attacco radiale - per IVR 304
Radial pressure gauge circle 50 - 63 mm - for IVR 304
Manometer Ø 50 - 63 mm - Anschluss unten, für IVR 304
Manomètre Ø 50 - 63mm - fixation radiale pour ivr 304
Радиальный манометр 50-63 мм для IVR 304

Cod./Code	DN	Ø	□/田	€
135802116	1/4"	Ø 50 - scala/scale 0-16 bar	1/100	7,28
135802206	1/4"	Ø 63 - scala/scale 0-6 bar	1/100	8,25
135802210	1/4"	Ø 63 - scala/scale 0-10 bar	1/100	8,25
135802216	1/4"	Ø 63 - scala/scale 0-16 bar	1/100	8,25

IVR 924 C



Cestello inox per filtro a Y in ottone IVR 924
Screen for Y strainer in stainless steel IVR 924
Edelstahlkäfig für Y-förmigen Filter aus Gusseisen IVR 924
Panier inox pour filtre en Y en fonte IVR 924
Корзина из нержавеющей стали для фильтра Y из чугуна IVR 924

Cod./Code	DN	□/田	€
334105001	1/2"	1	0,10
334107001	3/4"	1	0,15
334110001	1"	1	0,20
334112001	1" 1/4	1	0,25
334115001	1" 1/2	1	0,30
334120001	2"	1	0,60
334125001	2" 1/2	1	1,00
334130001	3"	1	1,30
334140001	4"	1	1,80



VALVOLE GAS
GAS VALVES
GASKUGELHÄHNE
VANNES GAZ
ЗАПОРНАЯ АРМАТУРА ДЛЯ ГАЗА





Valvole in ottone per gas **Brass Gas valves**

DIN	p. 219
Elite	p. 221
Elite ISO 7-1 RC	p. 224
Export ISO 7-1 RC	p. 227
Evergas	p. 229
Valvola a sfera con raccordo per presa pressione - Ball valve for gas with pressure gauge	p. 231



Valvola a sfera per gas in ghisa attacchi flangiati PN16 **Cast iron ball valve for gas - flanged ends PN16**

IVR 82	p. 236
IVR 83	p. 237



Valvola a farfalla in ghisa per gas **Cast iron butterfly valve for gas**

IVR 177	p. 238
IVR 277 CF8M	p. 238
IVR 178	p. 238
IVR 278 CF8M	p. 239



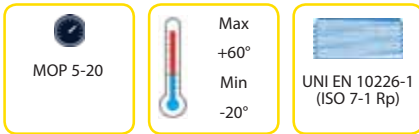

IVR DIN

IVR 100 DIN 100 DIN



Valvola a sfera per gas a passaggio totale omologata DVGW e HTB - attacchi F/F (DIN3357-4)
Full bore ball valve for gas approved by DVGW and HTB - threaded ends F/F (DIN3357-4)
Gas-Kugelhahn mit vollem Durchgang - DVGW- und HTB-Zulassung IG/IG (DIN3357-4)
Vanne à boisseau sphérique à passage intégral certifiée DVGW et HTB - fixations F/F (DIN3357-4)
Полнопроходной шаровой кран для газа (одобрено DVGW и HTB) - соединения В/В (DIN3357-4)



Cod./Code	DN	Ø	□/田	€
105003007	3/8"	10	10/120	5,73
105005007	1/2"	15	5/60	7,84
105007007	3/4"	20	15/60	10,48
105010007	1"	25	10/40	17,50
105012007	1"1/4	32	4/16	26,85
105015007	1"1/2	40	4/16	39,26
105020007	2"	50	2/8	63,28

IVR 100/A DIN 100 DIN



Valvola a sfera per gas a passaggio totale omologata DVGW e HTB - attacchi F/F (DIN3357-4)
Full bore ball valve for gas HTB - threaded ends F/F (DIN3357-4)
Gas-Kugelhahn mit vollem Durchgang - DVGW- und HTB-Zulassung IG/IG (DIN3357-4)
Vanne à boisseau sphérique à passage intégral certifiée HTB - fixations F/F (DIN3357-4)
Полнопроходной шаровой кран для газа (одобрено DVGW и HTB) - соединения В/В (DIN3357-4)





Cod./Code	DN	Ø	□/田	€
105003002	3/8"	10	10/120	5,72
105005002	1/2"	15	5/60	7,80
105007002	3/4"	20	15/60	10,46
105010002	1"	25	10/40	17,35

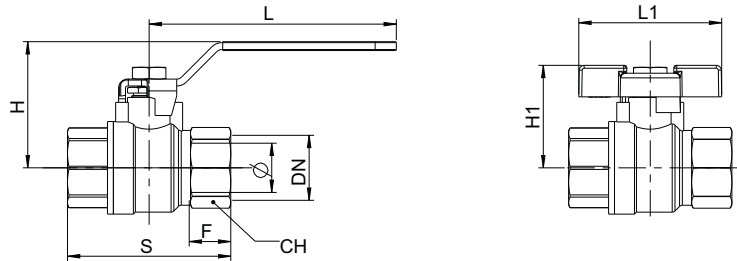



100 DIN		DIMENSIONI / DIMENSIONS													
DN	Ø	S	S1	S2	L	L1	L2	L4	H	H1	H2	H4	F	F1	CH
3/8"	10	60			80	50			40	33			19		22
1/2"	15	75			90	61			52	39			23		26
3/4"	20	80			90	61			55	43			23,5		31
1"	25	90			125	72			64	52			24,5		40
1"1/4	32	110			125				69				31		49
1"1/2	40	120			140				78				32		55
2"	50	141			140				85				36		68

100 DIN		ACCESSORI / RICAMBI - ACCESSORIES / SPARE PARTS						
	3/8"	1/2"	3/4"	1"	1"1/4	1"1/2	2"	
	700103501 € 0,60	700113501 € 0,78	700113501 € 0,78	700123501 € 1,05	700123501 € 1,05	700133501 € 1,47	700133501 € 1,47	
	703003501 € 0,64	703013501 € 0,81	703013501 € 0,81	703023501 € 0,95				
	750106001 € 0,43	750108001 € 0,44	750108001 € 0,44	750110001 € 0,48	750110001 € 0,48	750114001 € 0,55	750114001 € 0,55	



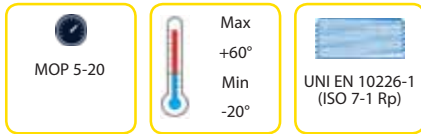

IVR ELITE

IVR 100 ELITE EN 331 - HTB EN 1775



Valvola a sfera per gas a passaggio totale HTB - attacchi F/F
Full bore ball valve for gas HTB - threaded ends F/F
Gas-Kugelhahn mit vollem Durchgang HTB - IG/IG
Vanne à boisseau sphérique à passage intégral certifiée HTB - fixations F/F
Полнопроходной шаровой кран для газа HTB - соединения В/В



(*) Non omologata
(*) Not certified
(*) Ohne Zulassung
(*) Pas certifiée
(*) Без сертификата

Cod./Code	DN	Ø	□/田	€
110002013	1/4"	10	10/120	4,52
110003013	3/8"	10	10/120	4,22
110005013	1/2"	15	12/72	6,97
110007013	3/4"	20	15/60	9,58
110010013	1"	25	10/40	15,76
110012013	1"1/4	32	6/24	23,36
110015013	1"1/2	40	4/16	36,77
110020013	2"	50	2/8	56,48
110025013	2"1/2	61	8	99,64 (*)
110030013	3"	74	6	139,04 (*)
110040013	4"	95	2	221,92 (*)

IVR 100/A ELITE EN 331 - HTB EN 1775



Valvola a sfera per gas a passaggio totale HTB - attacchi F/F
Full bore ball valve for gas HTB - threaded ends F/F
Gas-Kugelhahn mit vollem Durchgang HTB - IG/IG
Vanne à boisseau sphérique à passage intégral certifiée HTB - fixations F/F
Полнопроходной шаровой кран для газа HTB - соединения В/В



Cod./Code	DN	Ø	□/田	€
110002001	1/4"	10	10/120	4,53
110003001	3/8"	10	10/120	4,23
110005001	1/2"	15	12/72	6,96
110007001	3/4"	20	15/60	9,57
110010001	1"	25	10/40	15,62

IVR 101 ELITE EN 331 - HTB EN 1775



Valvola a sfera per gas a passaggio totale HTB - attacchi M/F
Full bore ball valve for gas HTB - threaded ends M/F
Gas-Kugelhahn mit vollem Durchgang - HTB-Zulassung - AG/IG
Vanne à boisseau sphérique à passage intégral certifiée HTB - fixations M/F
Полнопроходной шаровой кран для газа HTB - соединения Н/В



Cod./Code	DN	Ø	□/田	€
110103013	3/8"	10	10/120	4,49
110105013	1/2"	15	12/72	7,21
110107013	3/4"	20	15/60	10,10
110110013	1"	25	10/40	16,49
110112013	1"1/4	32	6/24	25,22
110115013	1"1/2	40	4/16	40,11
110120013	2"	50	2/8	59,49

IVR 101/A ELITE EN 331 - HTB EN 1775



Valvola a sfera per gas a passaggio totale HTB - attacchi M/F
Full bore ball valve for gas HTB - threaded ends M/F
Gas-Kugelhahn mit vollem Durchgang - HTB-Zulassung - AG/IG
Vanne à boisseau sphérique à passage intégral certifiée HTB - fixations M/F
Полнопроходной шаровой кран для газа HTB - соединения Н/В



Cod./Code	DN	Ø	□/田	€
110103001	3/8"	10	10/120	4,50
110105001	1/2"	15	12/72	7,19
110107001	3/4"	20	15/60	10,08
110110001	1"	25	10/40	16,36

IVR 100 LD ELITE EN 331 - HTB EN 1775



Valvola a sfera a passaggio totale omologata HTB - attacchi F/F - con maniglia lucchettabile
Full bore ball valve for gas HTB - threaded ends F/F - with lockable handle
Gas-Kugelhahn mit vollem Durchgang Zulassung nach HTB IG/IG - mit verriegelbarem Hebel
Vanne à boisseau sphérique à passage intégral certifiée HTB Fixations F/F - avec poignée cadenassable
Полнопроходной шаровой кран для газа - одобрено HTB - соединения В/В - с запираемой рукояткой



Cod./Code	DN	Ø	□/田	€
110002762	1/4"	10	10/120	6,03
110003762	3/8"	10	10/120	5,72
110005762	1/2"	15	12/72	8,63
110007762	3/4"	20	15/60	11,25
110010762	1"	25	10/40	17,82
110012762	1 1/4"	32	6/24	25,40
110015762	1 1/2"	40	4/16	40,32
110020762	2"	50	2/8	60,03

IVR 101 LD ELITE EN 331 - HTB EN 1775



Valvola a sfera a passaggio totale omologata HTB - attacchi M/F Con maniglia lucchettabile
Full bore ball valve for gas HTB - threaded ends M/F - with lockable handle
Kugelhahn mit vollem Durchgang Zulassung nach HTB AG/IG - mit verplombbarer Hebel
Vanne à boisseau sphérique à passage intégral certifiée HTB Fixations M/F - avec poignée cadenassable
Полнопроходной шаровой кран для газа - одобрено HTB - соединения Н/В - с запираемой рукояткой

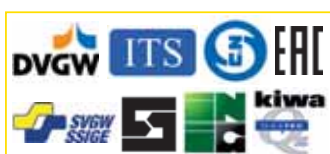

Cod./Code	DN	Ø	□/田	€
110103762	3/8"	10	10/120	6,00
110105762	1/2"	15	12/72	8,89
110107762	3/4"	20	15/60	11,76
110110762	1"	25	10/40	18,53
110112762	1 1/4"	32	6/24	27,26
110115762	1 1/2"	40	4/16	43,67
110120762	2"	50	4/16	63,05

IVR 182 ELITE GAS EN 331



Valvola a sfera a passaggio totale per gas con cappuccio piombabile - attacchi F/F
Full bore ball valve for gas with seal cap - threaded ends F/F
Gas-Kugelhahn mit vollem Durchgang mit verplombbarer Kappe IG/IG
Vanne à boisseau sphérique à passage intégral pour gaz avec capuchon plombable fixations F/F
Полнопроходной шаровой кран для газа с колпачком для пломбирования, соединения В/В

Cod./Code	DN	Ø	□/田	€
118205001	1/2"	15	10/60	8,43
118207001	3/4"	20	10/40	11,03
118210001	1"	25	10/40	16,86
118212001	1"1/4	32	6/24	24,20
118215001	1"1/2	40	5/20	37,06
118220001	2"	50	2/8	56,80

EAC

IVR 183 ELITE GAS EN 331



Valvola a sfera a passaggio totale per gas con cappuccio piombabile - attacchi M/F -
Full bore gas valve with sealing cap - threaded ends M/F
Gaskugelhahn mit vollem Durchgang mit verplombbarer Kappe - AG/IG
Vanne à boisseau sphérique pour gaz à passage intégral avec capuchon plombable fixations M/F
Полнопроходной шаровой кран для газа с колпачком для пломбирования - соединения Н/В

Cod./Code	DN	Ø	□/田	€
118305001	1/2"	15	10/60	8,66
118307001	3/4"	20	10/40	11,52
118310001	1"	25	10/40	17,60
118312001	1"1/4	32	6/24	26,06
118315001	1"1/2	40	5/20	40,37
118320001	2"	50	2/8	59,81

EAC

IVR 192 ELITE HTB



Valvola a sfera per gas a passaggio totale, con codolo - HTB. Attacchi filettati F/F
Full bore ball valve for gas with tang - HTB. F/F threaded ends
Gas-Kugelhahn mit vollem Durchgang HTB - IG/IG
Vanne a sphere pour gaz à passage intégrale avec queue - HTB. Taraudage F/F
Полнопроходной шаровой кран для газа с хвостовиком - HTB. Резьба: В/В

Cod./Code	DN	Ø	□/田	€
119205007	1/2" ELI FF HTB C/COD MP GIA	15	12/48	12,79
119207007	3/4" ELI FF HTB C/COD MP GIA	20	10/40	19,75
119210007	1" ELI FF HTB C/COD MP GIA	25	8/32	30,73

EAC

IVR ELITE ISO 7-1 RC



MOP 5-20

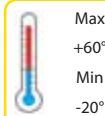

Max
 +60°
 Min
 -20°

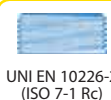

UNI EN 10226-2
 (ISO 7-1 Rc)

IVR 190 ELITE HTB (ISO 7-1 RC)



Valvola a sfera per gas a passaggio totale HTB - attacchi F/F
 Full bore ball valve for gas HTB - threaded ends F/F
 Gas-Kugelhahn mit vollem Durchgang HTB - IG/IG
 Vanne à boisseau sphérique pour gaz à passage intégral HTB - fixations F/F
 Полнопроходной шаровой кран для газа HTB - соединения В/В

Cod./Code	DN	Ø	□/田	€
119002001	1/4"	10	10/120	4,36
119003001	3/8"	10	10/120	4,18
119005001	1/2"	15	12/72	6,96
119007001	3/4"	20	15/60	9,45
119010001	1"	25	10/40	15,45
119012001	1 1/4"	32	6/24	22,90
119015001	1 1/2"	40	4/16	36,23
119020001	2"	50	2/8	56,06



IVR 190/A ELITE HTB (ISO 7-1 RC)



Valvola a sfera per gas a passaggio totale HTB - attacchi F/F
 Full bore ball valve for gas HTB - threaded ends F/F
 Gas-Kugelhahn mit vollem Durchgang HTB - IG/IG
 Vanne à boisseau sphérique pour gaz à passage intégral HTB - fixations F/F
 Полнопроходной шаровой кран для газа HTB - соединения В/В

Cod./Code	DN	Ø	□/田	€
119002002	1/4"	10	10/120	4,37
119003002	3/8"	10	10/120	4,19
119005002	1/2"	15	12/72	6,95
119007002	3/4"	20	15/60	9,44
119010002	1"	25	10/40	15,32
119012002	1 1/4"	32	6/24	22,78



IVR 191 ELITE HTB (ISO 7-1 RC)



Valvola a sfera per gas a passaggio totale HTB - attacchi M/F
Full bore ball valve for gas HTB - threaded ends M/F
Gas-Kugelhahn mit vollem Durchgang HTB - AG/IG
Vanne à boisseau sphérique pour gaz à passage intégral HTB - fixations M/F
Полнопроходной шаровой кран для газа HTB - соединения Н/В



Cod./Code	DN	Ø	□/田	€
119103001	3/8"	10	10/120	4,42
119105001	1/2"	15	12/72	7,19
119107001	3/4"	20	15/60	10,10
119110001	1"	25	10/40	16,13
119112001	1"1/4	32	6/24	24,73
119115001	1"1/2	40	4/16	39,41
119120001	2"	50	4/16	58,24

IVR 191/A ELITE HTB (ISO 7-1 RC)



Valvola a sfera per gas a passaggio totale HTB - attacchi M/F
Full bore ball valve for gas HTB - threaded ends M/F
Gas-Kugelhahn mit vollem Durchgang HTB - AG/IG
Vanne à boisseau sphérique pour gaz à passage intégral HTB - fixations M/F
Полнопроходной шаровой кран для газа HTB - соединения Н/В



Cod./Code	DN	Ø	□/田	€
119103002	3/8"	10	10/120	4,43
119105002	1/2"	15	12/72	7,36
119107002	3/4"	20	15/60	10,08
119110002	1"	25	10/40	16,01
119112002	1"1/4	32	6/24	24,60



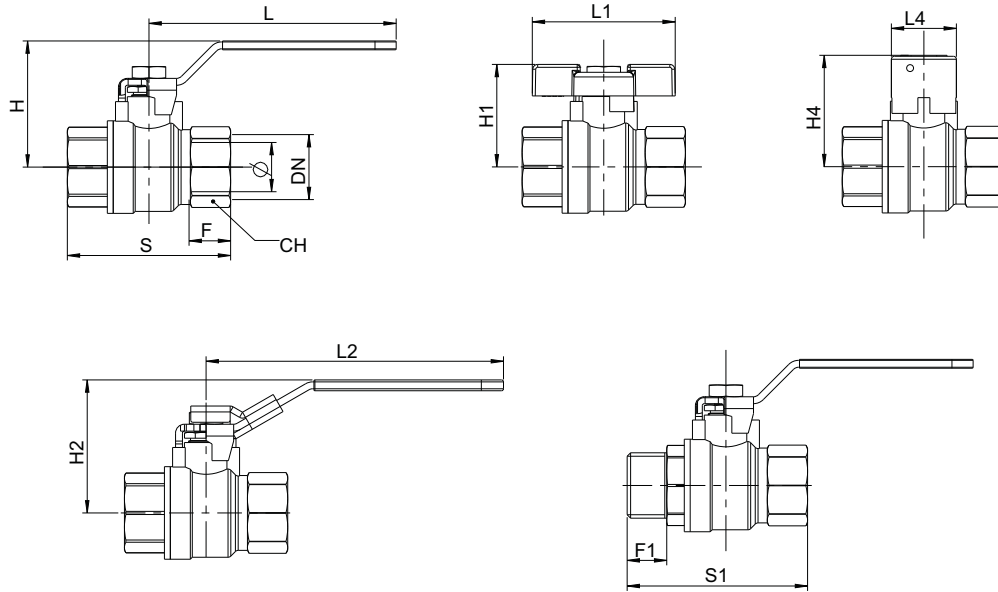

ELITE															
DIMENSIONI / DIMENSIONS															
DN	Ø	S	S1	S2	L	L1	L2	L4	H	H1	H2	H4	F	F1	CH
1/4"	10	45	42		80	50	95		41	33	43		12	10	21
3/8"	10	45	54		80	50	95		41	33	43		12	12	21
1/2"	15	63	70		90	61	120	29	52	39	56	45	17	15	26
3/4"	20	71	80		90	61	120	29	55	43	60	49	19,5	16	31
1"	25	83	92		125	72	150	33	65		68	56	21	19	38
1 1/4"	32	92	102		125		150	33	69		73	61	22	20,5	48
1 1/2"	40	104	117		140		160	44	78		87	75	23,5	21,5	55
2"	50	124	137		140		160	44	85		94	82	28	24,5	68
2 1/2"	60	140			250				131				28		85
3"	74	159			250				140				30,5		99
4"	94	196			250				156				38		125

ELITE												
ACCESSORI / RICAMBI - ACCESSORIES / SPARE PARTS												
	1/4"	3/8"	1/2"	3/4"	1"	1 1/4"	1 1/2"	2"	2 1/2"	3"	4"	
	700103501 € 0,60	700103501 € 0,60	700113501 € 0,78	700113501 € 0,78	700123501 € 1,05	700123501 € 1,05	700133501 € 1,47	700133501 € 1,47	700443501 € 3,66	700443501 € 3,66	700153501 € 5,47	
	703003501 € 0,64	703003501 € 0,64	703013501 € 0,81	703013501 € 0,81	703023501 € 0,95	703023501 € 0,95						
	125703907 € 1,94	125703907 € 1,94	125705907 € 2,37	125705907 € 2,37	125710907 € 3,01	125710907 € 3,01	125715907 € 5,18	125715907 € 5,18				
	750106001 € 0,43	750106001 € 0,43	750108001 € 0,44	750108001 € 0,44	750110001 € 0,48	750110001 € 0,48	750114001 € 0,55	750114001 € 0,55	750116001 € 0,59	750116001 € 0,59		
			706013501 € 1,56	706013501 € 1,56	706023501 € 1,73	706023501 € 1,73	706033501 € 2,39	706033501 € 2,39				

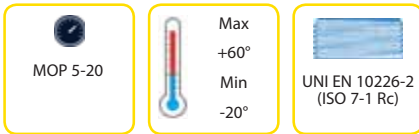

IVR EXPORT ISO 7-1 RC

IVR 45 GAS EXPORT EN 331 (ISO 7-1 RC)



Valvola a sfera a passaggio totale - attacchi F/F
Full bore gas valve - threaded ends F/F
Gas-Kugelhahn mit vollem Durchgang - IG/IG
Vanne à boisseau sphérique à passage intégral - fixations F/F
Полнопроходной шаровой кран для газа - соединения В/В

Cod./Code	DN	Ø	□/田	€
104502008	1/4"	10	10/120	4,57
104503008	3/8"	10	10/120	4,19
104505008	1/2"	15	12/72	7,36
104507008	3/4"	20	15/60	9,94
104510008	1"	25	10/40	16,20
104512008	1"1/4	32	6/24	23,49
104515008	1"1/2	40	4/16	35,97
104520008	2"	50	2/8	56,00



IVR 45/A GAS EXPORT EN 331 (ISO 7-1 RC)



Valvola a sfera a passaggio totale - attacchi F/F
Full bore gas valve - threaded ends F/F
Gas-Kugelhahn mit vollem Durchgang - IG/IG
Vanne à boisseau sphérique à passage intégral - fixations F/F
Полнопроходной шаровой кран для газа - соединения В/В

Cod./Code	DN	Ø	□/田	€
104502005	1/4"	10	10/120	4,51
104503005	3/8"	10	10/120	4,13
104505005	1/2"	15	12/72	7,28
104507005	3/4"	20	15/60	9,87
104510005	1"	25	10/40	15,96



IVR 45 LD GAS EXPORT EN 331 LD (ISO 7-1 RC)



Valvola a sfera a passaggio totale - attacchi F/F - con maniglia lucchettabile
Full bore gas valve - threaded ends F/F - with lockable handle
Gas-Kugelhahn mit vollem Durchgang - IG/IG - mit verriegelbarem Hebel
Vanne à boisseau sphérique à passage intégral - fixations F/F - avec poignée cadenassable
Полнопроходной шаровой кран для газа - соединения В/В - с запираемой рукояткой

Cod./Code	DN	Ø	□/田	€
104502757	1/4"	10	10/120	6,17
104503757	3/8"	10	10/120	5,69
104505757	1/2"	15	12/72	9,03
104507757	3/4"	20	15/60	11,62
104510757	1"	25	20/40	18,23
104512757	1"1/4	32	6/24	25,52
104515757	1"1/2	40	4/16	39,52
104520757	2"	50	4/16	59,36



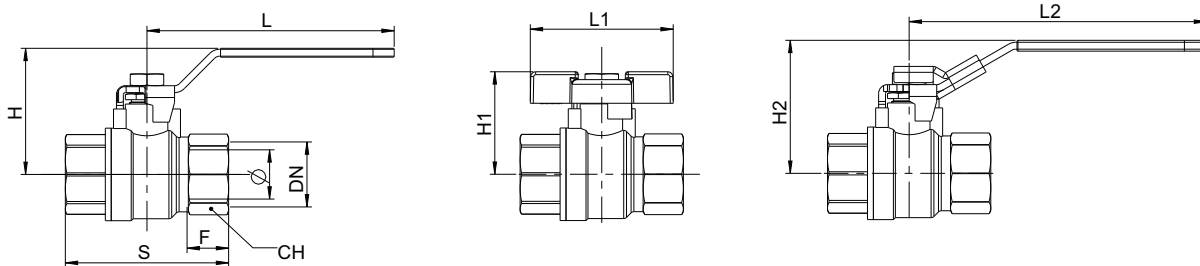

EXPORT ISO 7-1 RC

DIMENSIONI / DIMENSIONS

DN	Ø	S	S1	S2	L	L1	L2	L5	H	H1	H2	H5	F	F1	CH
1/4"	10	45			80	50	95		41	33	43		12		21
3/8"	10	45			80	50	95		41	33	43		12		21
1/2"	15	63			90	61	120		52	39	56		17		26
3/4"	20	71			90	61	120		55	43	60		19,5		31
1"	25	83			125	72	150		65		68		21		38
1"1/4	32	92			125		150		69		73		22		48
1"1/2	40	104			140		160		78		87		23,5		55
2"	50	124			140		160		85		94		28		68
2"1/2	60	140			250				131				28		85
3"	74	159			250				140				30,5		99
4"	94	196			250				156				38		125

EXPORT ISO 7-1 RC

ACCESSORI / RICAMBI - ACCESSORIES / SPARE PARTS

	1/4"	3/8"	1/2"	3/4"	1"	1"1/4	1"1/2	2"	2"1/2	3"	4"
	700103001 € 0,60	700103001 € 0,60	700113001 € 0,76	700113001 € 0,76	700123001 € 1,05	700123001 € 1,05	700133001 € 1,47	700133001 € 1,47	700153001 € 5,47	700153001 € 5,47	700153001 € 5,47
	703003201 € 0,56	703003201 € 0,56	703013201 € 0,70	703013201 € 0,70	703023201 € 0,83						
	125703907 € 1,94	125703907 € 1,94	125705907 € 2,37	125705907 € 2,37	125710907 € 3,01	125710907 € 3,01	125715907 € 5,18	125715907 € 5,18			
	750106001 € 0,43	750106001 € 0,43	750108001 € 0,44	750108001 € 0,44	750110001 € 0,48	750110001 € 0,48	750114001 € 0,55	750114001 € 0,55	750118001 € 0,74	750118001 € 0,74	750118001 € 0,74

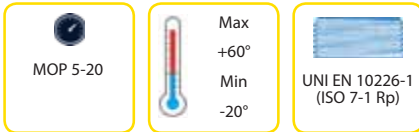

IVR EVERGAS

IVR 151 EVERGAS EN 331



Valvola a sfera per gas a passaggio standard - attacchi F/F
Standard bore ball valve for gas - threaded ends F/F
Gas-Kugelhahn mit normalem Durchgang - IG/IG
Vanne à boisseau sphérique pour gaz à passage normal - fixations F/F
Шаровой кран для газа со стандартным проходом - соединения В/В



Cod./Code	DN	Ø	□/田	€
115105007	1/2"	14	12/72	5,36
115107007	3/4"	18	20/80	7,26
115110007	1"	23	12/48	12,78
115112007	1"1/4	29	8/32	19,23
115115007	1"1/2	37	4/16	28,73
115120007	2"	47	4/16	46,46

IVR 151/A EVERGAS EN 331



Valvola a sfera per gas a passaggio standard - attacchi F/F
Standard bore ball valve for gas - threaded ends F/F
Gas-Kugelhahn mit normalem Durchgang - IG/IG
Vanne à boisseau sphérique pour gaz à passage normal - fixations F/F
Шаровой кран для газа со стандартным проходом - соединения В/В



Cod./Code	DN	Ø	□/田	€
115105008	1/2"	14	12/144	5,32
115107008	3/4"	18	20/80	7,21
115110008	1"	23	12/48	12,70

IVR 152 EVERGAS EN 331



Valvola a sfera per gas a passaggio standard - attacchi M/F
Standard bore ball valve for gas - threaded ends M/F
Gas-Kugelhahn mit normalem Durchgang - AG/IG
Vanne à boisseau sphérique pour gaz à passage normal - fixations M/F
Шаровой кран для газа со стандартным проходом - соединения Н/В



Cod./Code	DN	Ø	□/田	€
115205007	1/2"	14	12/72	5,74
115207007	3/4"	18	20/80	7,74
115210007	1"	23	12/48	13,74
115212007	1"1/4	29	6/24	21,44
115215007	1"1/2	37	4/16	30,02
115220007	2"	47	4/16	50,02



IVR 152/A EVERGAS EN 331



Valvola a sfera per gas a passaggio standard - attacchi M/F
 Standard bore ball valve for gas - threaded ends M/F
 Gas-Kugelhahn mit normalem Durchgang - AG/IG
 Vanne à boisseau sphérique pour gaz à passage normal - fixations M/F
 Шаровой кран для газа со стандартным проходом - соединения Н/В

Cod./Code	DN	Ø	□/田	€
115205008	1/2"	14	12/144	5,70
115207008	3/4"	18	20/80	7,79
115210008	1"	23	12/48	13,64

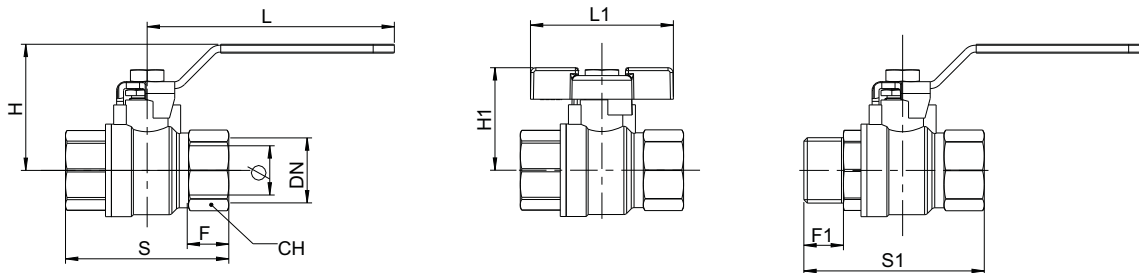

EVERGAS

DIMENSIONI / DIMENSIONS

DN	Ø	S	S1	S2	L	L1	L2	L3	H	H1	H2	H3	F	F1	CH
1/2"	14	55	63,5		92	50			42,5	36			15	15	25
3/4"	18	61,5	69		92	50			45	39			16	16	31
1"	23	73	81,5		115	61			60	45			18	18	38
1"1/4	29	85,5	94,5		115				64				20,5	20,5	47
1"1/2	37	97	106		150				74,5				20,5	20,5	54
2"	47	117	129		150				81,5				25,5	25	66

EVERGAS

ACCESSORI / RICAMBI - ACCESSORIES / SPARE PARTS

	1/2"	3/4"	1"	1"1/4	1"1/2	2"
	700413501 € 0,70	700413501 € 0,70	700423501 € 0,92	700423501 € 0,92	700433501 € 1,40	700433501 € 1,40
	703003501 € 0,64	703003501 € 0,64	703013501 € 0,81	703013501 € 0,81		
	125703907 € 1,94	125703907 € 1,94	125705907 € 2,37	125705907 € 2,37	125710907 € 3,01	125710907 € 3,01
	750106001 € 0,43	750106001 € 0,43	750108001 € 0,44	750108001 € 0,44	750110001 € 0,48	750110001 € 0,48

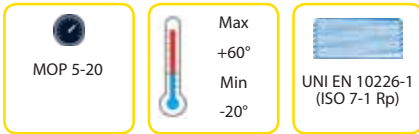

IVR PRESA PRESSIONE

IVR 212 CONFORME EN 331



Valvola a sfera con raccordo per presa pressione
Full bore ball valve for gas with pressure gauge
Kugelhahn mit Anschluss für Druckanschluss
Vanne à boisseau sphérique avec raccord pour prise pression
Полнопроходной шаровой кран для газа с соединением для точки отбора



Cod./Code	DN	Ø	□/田	€
121205007	1/2"	15	10/40	9,08
121207007	3/4"	20	15/60	11,86
121210007	1"	25	12/48	18,32

IVR 212/A CONFORME EN 331



Valvola a sfera con raccordo per presa pressione
Full bore ball valve for gas with pressure gauge
Kugelhahn mit Anschluss für Druckanschluss
Vanne à boisseau sphérique avec raccord pour prise pression
Полнопроходной шаровой кран для газа с соединением для точки отбора



Cod./Code	DN	Ø	□/田	€
121205008	1/2"	15	10/60	9,03
121207008	3/4"	20	20/80	11,83
121210008	1"	25	12/48	18,19

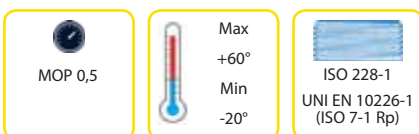

IVR RUBINETTI

IVR 110 UNI CIG



Rubinetto a sfera a squadra per gas EN 14800:2007 - attacchi F/F
Angle ball valve with spread for gas with fastening for flexible metallic pipe EN 14800:2007 - threaded ends F/F
Gas-Kugelhahn, eckförmig EN 14800:2007 - IG/IG
Robinet à boisseau sphérique à équerre pour gaz EN 14800:2007 - fixations F/F
Угловой шаровой кран для газа EN 14800:2007 - соединения В/В



Cod./Code	DN	Ø	□/田	€
111005010	1/2" x 1/2"	12,5	10/120	6,91

IVR 111 UNI CIG



Rubinetto a sfera a squadra per gas EN 14800:2007 - attacchi M/F
Angle ball valve with spread for gas with fastening for flexible metallic pipe EN 14800:2007 - threaded ends M/F
Gas-Kugelhahn, eckförmig EN 14800:2007 - AG/IG
Robinet à boisseau sphérique à équerre pour gaz EN 14800:2007 - fixations M/F
Угловой шаровой кран для газа EN 14800:2007 - соединения H/B



Cod./Code	DN	Ø	□/田	€
111105010	1/2" x 1/2"	12,5	10/120	6,96

IVR 112 UNI CIG



Rubinetto a sfera a squadra per gas EN 14800:2007 - attacchi M/M
Angle ball valve with spread for gas with fastening for flexible metallic pipe EN 14800:2007 - threaded ends M/M
Gas-Kugelhahn, eckförmig EN 14800:2007 - AG/AG
Robinet à boisseau sphérique à équerre pour gaz EN 14800:2007 - fixations M/M
Угловой шаровой кран для газа EN 14800:2007 - соединения H/H



Cod./Code	DN	Ø	□/田	€
111205010	1/2" x 1/2"	12,5	10/120	6,76

IVR 118 UNI CIG



Rubinetto a sfera a squadra per gas EN 14800:2007 - attacchi M/F
Angle ball valve with spread for gas with fastening for flexible metallic pipe EN 14800:2007 - threaded ends M/F
Gas-Kugelhahn, eckförmig EN 14800:2007 - AG/IG
Robinet à boisseau sphérique à équerre pour gaz EN 14800:2007 - fixations M/F
Угловой шаровой кран для газа EN 14800:2007 - соединения H/B



Cod./Code	DN	Ø	□/田	€
111805010	1/2" x 1/2"	12,5	10/120	6,71



IVR 113 UNI CIG



Rubinetto a sfera a squadra per gas EN 14800:2007 - attacchi M - Dado folle
Angle ball valve EN 14800:2007 with M connection - Loose nut
Gas-Kugelhahn, eckförmig EN 14800:2007 - Anschlüsse AG - Überwurfmutter
Robinet à boisseau sphérique à équerre pour gaz EN 14800:2007 - fixations M - écrou tournant
Угловой шаровой кран для газа EN 14800:2007 - соединения Н - Свободная гайка



Cod./Code	DN	Ø	□/田	€
111305010	1/2" x 1/2"	12,5	10/120	8,46
111305020	1/2" x 3/4"	12,5	10/120	8,78

IVR 114 UNI CIG



Rubinetto a sfera a squadra per gas EN 14800:2007 - attacchi F - Dado folle
Angle ball valve EN 14800:2007 with F connection - Loose nut
Gas-Kugelhahn, eckförmig EN 14800:2007 - Anschlüsse IG - Überwurfmutter
Robinet à boisseau sphérique à équerre pour gaz EN 14800:2007 - fixations F - écrou tournant
Угловой шаровой кран для газа EN 14800:2007 - соединения В - Свободная гайка



Cod./Code	DN	Ø	□/田	€
111405010	1/2" x 1/2"	12,5	10/120	8,66
111405020	1/2" x 3/4"	12,5	10/120	8,97

IVR 116 UNI CIG



Rubinetto a sfera diritto per gas EN 14800:2007 - attacchi M - Dado folle
Straight ball valve EN 14800:2007 with M connection - Loose nut
Gas-Kugelhahn mit gerader Verschraubung EN 14800:2007 AG - Überwurfmutter
Robinet à boisseau sphérique droit pour gaz EN 14800:2007 - fixations M - écrou tournant
Прямой шаровой кран для газа EN 14800:2007 - соединения Н - Свободная гайка



Cod./Code	DN	Ø	□/田	€
111605010	1/2" x 1/2"	12,5	10/120	8,04
111605020	1/2" x 3/4"	12,5	10/120	8,04

IVR 117 UNI CIG



Rubinetto a sfera diritto per gas EN 14800:2007 - attacchi F - Dado folle
Straight ball valve EN 14800:2007 with F connection - Loose nut
Gas-Kugelhahn mit gerader Verschraubung EN 14800:2007 - Anschlüsse IG - Überwurfmutter
Robinet à boisseau sphérique droit pour gaz EN 14800:2007 - fixations F - écrou tournant
Прямой шаровой кран для газа EN 14800:2007 - соединения В - Свободная гайка



Cod./Code	DN	Ø	□/田	€
111705010	1/2" x 1/2"	12,5	10/120	8,00
111705020	1/2" x 3/4"	12,5	10/120	7,99



IVR 161 UNI CIG

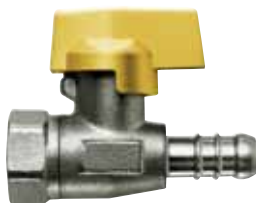

Rubinetto dritto per gas - attacchi F - portagomma
Straight ball valve for gas - threaded ends F - Rubber hose connection
Gas-Kugelhahn mit Schlauchanschluss - Anschluss IG
Robinet a boisseau spherique pour gaz - fixations F - Porte tuyeau souple
Прямой шаровой кран для газа - соединения В - насадка для резинового шланга

Cod./Code	DN	Ø	□/田	€
116103000	3/8" x 8	12,5	15/90	9,74
116103001	3/8" x 13	12,5	15/90	9,74
116105000	1/2" x 8	12,5	15/90	6,37
116105002	1/2" x 13	12,5	15/90	6,58

IVR 162 UNI CIG



Rubinetto dritto per gas - attacchi M - portagomma
Straight ball valve for gas - threaded ends M - Rubber hose connection
Gas-Kugelhahn mit gerader Verschraubung mit Schlauchanschluss - Anschluss AG
Robinet a boisseau spherique pour gaz - fixations M - Porte tuyeau souple
Прямой шаровой кран для газа - соединения Н - насадка для резинового шланга

Cod./Code	DN	Ø	□/田	€
116203000	3/8" x 8	12,5	15/90	9,74
116203002	3/8" x 13	12,5	15/90	9,74
116205000	1/2" x 8	12,5	15/90	6,42
116205002	1/2" x 13	12,5	15/90	6,63

IVR 193 UNI CIG



Rubinetto angolo per gas - attacchi F - Portagomma
Angle ball valve for gas - threaded ends F - rubber hose connection
Eckförmiger Gas-Kugelhahn mit Schlauchanschluss - Anschluss IG
Robinet a equerre pour gaz - fixations F - porte tuyeau souple
Прямой шаровой кран для газа - соединения В - насадка для резинового шланга

Cod./Code	DN	Ø	□/田	€
119303001	3/8" x 8	12,5	15/90	10,65
119303002	3/8" x 13	12,5	15/90	10,65
119305001	1/2" x 8	12,5	15/90	7,13
119305002	1/2" x 13	12,5	15/90	7,43

IVR 194 UNI CIG



Rubinetto angolo per gas - attacchi M - Portagomma
Angle ball valve for gas - threaded ends M - rubber hose connection
Eckförmiger Gas-Kugelhahn eckförmig mit Schlauchanschluss - Anschlüsse AG
Robinet a equerre pour gaz - fixations M - porte tuyeau souple
Угловой шаровой кран для газа - соединения Н - насадка для резинового шланга

Cod./Code	DN	Ø	□/田	€
119403001	3/8" x 8	12,5	15/90	10,43
119403002	3/8" x 13	12,5	15/90	10,43
119405001	1/2" x 8	12,5	15/90	6,93
119405002	1/2" x 13	12,5	15/90	7,23

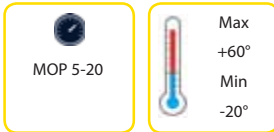

IVR INCASSO

IVR 273 UNI CIG



Rubinetto a sfera da incasso gas con flangetta di fissaggio e perno di supporto - UNI CIG 7129
Completo di leva e attacchi a saldare per tubo rame

Built-in monoblock ball valve for gas, according to standard UNI CIG 7129
Complete with butt weld connections for copper pipe

Gas-Unterputzarmatur-Kugelhahn mit Befestigungsflansch und Auflagestift - UNI CIG 7129 - mit Griff. -
Anschlüsse für Kupferrohr

Robinet à boisseau sphérique à encastrer gaz, avec patte d'ancrage et tasseaux, conforme à la norme
UNI CIG 7129 - pourvu de fixations à souder pour tube en cuivre

Встроенный в моноблок шаровой кран для газа - стандарт UNI CIG7129 - Укомплектован ручкой и
соединениями под пайку для медных труб



Cod./Code	DN	Ø	□/田	€
127305401	14	14	1/10	64,76
127305601	16	14	1/10	60,75



Cod./Code	DN	Ø	□/田	€
127300002	Sportello cromato / Chrome cover		5/50	16,84



Cod./Code	DN	Ø	□/田	€
127300001	Sportello bianco / White cover		5/50	10,80

IVR 274



Rubinetto a sfera da incasso gas, ispezionabile come da norma UNI CIG 7129
Completo di attacchi a saldare per tubo rame

Built-in ball valve for gas, openable box for inspection according standard UNI CIG 7129
Complete with butt weld connections for copper pipe

Gas-Unterputzarmatur-Kugelhahn, inspektionierbar gemäß Norm UNI CIG 7129 - Anschlüsse für Kupfer-
rohr zum schweißen

Robinet à boisseau sphérique à encastrer gaz, contrôlable conforme à la norme UNI CIG 7129
Pourvu de fixations à souder pour tube en cuivre

Встраиваемый шаровой кран для газа, инспекционный, согласно норме UNI CIG 7129. Соединение
под сварку для медной трубы



Cod./Code	DN	Ø	□/田	€
127405401	1/2" x 14	14	1/10	66,22
127405601	1/2" x 16	14	1/10	66,22
109770274	Prolunga / Stem extention		50/200	7,25

IVR GHISA

PN16



Max
+60°
Min
-20°

UNI EN 1092

IVR 82



Valvola a sfera in ghisa GJS 400 per gas - attacchi flangiati PN16
Cast iron GJS 400 ball valve for gas - flanged ends PN16
Kugelhahn aus Gusseisen GJS 400 für Gas - Flanschanschlüsse PN16
Vanne à boisseau sphérique en fonte GJS 400 pour gaz - fixations bridées PN16
Фланцевый шаровой кран для газа из чугуна GJS 400 - фланцевые соединения PN 16



Cod./Code	DN	Ø	ISO 5211	□/田	€
108207052	20	20	F04	10	96,93
108210052	25	25	F04	8	110,51
108212052	32	32	F04	5	122,64
108215052	40	40	F05	5	133,17
108220052	50	50	F05	3	150,65
108225052	65	61	F07	2	232,30
108230052	80	74	F07	1	286,15
108240052	100	95	F07	1	311,87
108250012	125	120	F10	1	597,23
108260012	150	145	F10	1	797,78

IVR 82 + IVR 180



IVR 82 - Valvola flangiata in ghisa GJS 400 per gas Attacchi flangiati PN 16
+ IVR 180 - Riduttore di manovra manuale
IVR 82 - Cast iron GJL 400 ball valve for gas - flanged ends PN 16
+ IVR 180 - Manual gearbox
IVR 82 - FlanschKugelhahn aus Gusseisen GJS 400 für Gas Flanschanschlüsse PN 16
+ IVR 180 - Manuelles Getriebe
IVR 82 - Vanne bride en fonte GJS 400 pour gaz Fixations bridées PN 16
+ IVR 180 - Réducteur de manoeuvre manuelle
IVR 82 Шаровой фланцевый кран для газа из чугуна GJS 400 - фланцевые соединения PN 16
+ IVR 180 - Ручной редуктор управления



Cod./Code	DN	Ø	ISO5211	□/田	€
408215070	40	40	F05	1	262,06
408220070	50	50	F05	1	279,80
408225070	65	61	F07	1	353,14
408230070	80	74	F07	1	413,48
408240070	100	95	F07	1	439,05
408250070	125	120	F10	1	755,20
408260070	150	145	F10	1	955,75

IVR 83



Valvola a sfera in ghisa GJS 400 per gas - asta e sfera inox - attacchi flangiati PN16
Cast iron GJS 400 ball valve for gas - stainless steel stem and ball - flanged ends PN16
Kugelhahn aus Gusseisen GJS 400 für Gas - Stab und Kugel aus Edelstahl - Flanschanschlüsse PN16
Vanne à boisseau sphérique en fonte GJS 400 pour gaz - tige et sphère inox - fixations bridées PN16
Фланцевый шаровой кран для газа из чугуна GJS 400 - Шток и шар из нержавеющей стали
- фланцевые соединения PN 16

Cod./Code	DN	Ø	ISO5211	□/田	€
108307052	20	20	F04	10	93,92
108310052	25	25	F04	10	126,84
108312052	32	32	F04	5	140,45
108315052	40	40	F05	5	168,46
108320052	50	50	F05	4	192,83
108325052	65	61	F07	2	265,46
108330052	80	74	F07	2	340,50
108340052	100	95	F07	2	401,70
108350012	125	120	F10	1	737,02
108360012	150	145	F10	1	1054,87



IVR 83 + IVR 180



IVR 83 Valvola flangiata in ghisa GJS 400 per gas Asta e sfera inox - att. PN 16
+ IVR 180 Riduttore di manovra manuale
IVR 83 - Cast iron GJS 400 ball valve for gas - s.s. stem and ball Flanged ends PN 16
+ IVR 180 - Manual gearbox
IVR 83 Gas-Flansch-Kugelhahn aus Gusseisen GJS 400 - Stab und Kugel aus Edelstahl - Anschluss
+ IVR 180 Manuelles Getriebe
IVR 83 Vanne bride en fonte GJS 400 pour gaz - tige et sphère inox - att. PN 16
+ Edelstahl - Anschluss PN IVR 180 Réducteur de manoeuvre manuelle
IVR 83 Шаровой фланцевый кран для газа из чугуна GJS 400 - Шток и шар из нержавеющей стали
- фланцевые соединения PN 16 + IVR 180 - Ручной редуктор управления

Cod./Code	DN	Ø	ISO5211	□/田	€
408315070	40	40	F05	1	297,62
408320070	50	50	F05	1	321,98
408325070	65	61	F07	1	392,79
408330070	80	74	F07	1	467,83
408340070	100	95	F07	1	529,08
408350070	125	120	F10	1	894,99
408360070	150	145	F10	1	1.212,84



82 / 83

ACCESSORI / RICAMBI - ACCESSORIES / SPARE PARTS

	20	25	32	40	50	65	80	100	125	150
		702023501 € 1,99		702033501 € 2,67		702053501 € 4,27		702063501 € 13,74		
		750720601 € 1,10		750730801 € 2,92		750740801 € 2,32		750751001 € 3,19		
				118020010 € 96,45		118030010 € 96,45		118050010 € 136,60		
		109710100 € 21,31		109715100 € 70,07		109725100 € 135,95		109740100 € 274,43		
	334206071 € 5,50	334206101 € 6,27	334206121 € 5,66	334206151 € 8,07	334206201 € 8,06	334206251 € 13,48	334206301 € 20,95	334206401 € 23,58	334206501 € 67,94	334206601 € 107,26

IVR 177



Valvola a farfalla in ghisa GJS 400 tipo LUG per gas
Butterfly valve for gas LUG type GJS 400
Ventil mit Flügelgriff aus Gusseisen GJS 400 Typ LUG für Gas
Vanne papillon en fonte GJS 400 type LUG pour gaz
Дисковый затвор «Баттерфляй» для газа из чугуна GJS 400– тип LUG



Cod./Code	DN	Ø	ISO5211	□/田	€
117715001	40	40	F05	1/8	60,42
117720001	50	50	F05	1/5	63,59
117725001	65	65	F05	2	74,54
117730001	80	80	F05	2	80,25
117740001	100	100	F07	2	116,82
117750001	125	125	F07	1	156,10
117760001	150	150	F07	1	178,00
117780001	200	200	F10	1	297,35
117790001	250	250	F10	1	411,17
117795001	300	300	F12	1	658,84

IVR 277 CF8M



Valvola a farfalla in ghisa GJS 400 tipo LUG per gas - disco inox CF8M
Butterfly valve for gas LUG type GJS 400 with SS disc CF8M
Ventil mit Flügelgriff aus Gusseisen GJS 400 Typ LUG für Gas - Edelstahl-scheibe CF8M
Vanne papillon en fonte GJS 400 type LUG pour gaz disque inox CF8M
Дисковый затвор «Баттерфляй» для газа из чугуна GJS 400 - тип LUG - диск из нержавеющей стали CF8M



Cod./Code	DN	Ø	ISO5211	□/田	€
127715001	40	40	F05	1/8	61,05
127720001	50	50	F05	1/3	65,49
127725001	65	65	F05	1/2	78,98
127730001	80	80	F05	1/2	89,34
127740001	100	100	F07	1/2	134,03
127750001	125	125	F07	1	185,31
127760001	150	150	F07	1	231,01
127780001	200	200	F10	1	382,54
127790001	250	250	F10	1	645,10
127795001	300	300	F12	1	990,14

IVR 178



Valvola a farfalla in ghisa GJS 400 tipo WAFER per gas
Butterfly valve for gas WAFER type GJS 400
Ventil mit Flügelgriff aus Gusseisen GJS 400 Typ WAFER für Gas
Vanne papillon en fonte GJS 400 type WAFER pour gaz
Дисковый затвор «Баттерфляй» для газа из чугуна GJS 400– тип WAFER



Cod./Code	DN	Ø	ISO5211	□/田	€
117815001	40	40	F05	1/8	51,07
117820001	50	50	F05	1/6	60,59
117825001	65	65	F05	1/3	70,48
117830001	80	80	F05	2	75,81
117840001	100	100	F07	2	111,32
117850001	125	125	F07	1	148,61
117860001	150	150	F07	1	169,71
117880001	200	200	F10	1	284,96
117890001	250	250	F10	1	395,44
117895001	300	300	F12	1	634,57

IVR 278 CF8M





Valvola a farfalla in ghisa GJS 400 tipo WAFER per gas - disco inox CF8M
Butterfly valve for gas WAFER type GJS 400 with SS disc CF8M
Ventil mit Flügelgriff aus Gusseisen GJS 400 Typ WAFER für Gas - Edelstahlscheibe CF8M
Vanne papillon en fonte GJS 400 type WAFER pour gaz disque inox CF8M
Дисковый затвор «Баттерфляй» для газа из чугуна GJS 400– тип WAFER – диск из нержавеющей стали CF8M



Cod./Code	DN	Ø	ISO5211	□/田	€
127815001	40	40	F05	1/8	58,05
127820001	50	50	F05	1/4	62,49
127825001	65	65	F05	1/3	75,00
127830001	80	80	F05	1/2	85,02
127840001	100	100	F07	1/2	128,66
127850001	125	125	F07	1	178,00
127860001	150	150	F07	1	222,94
127880001	200	200	F10	1	370,37
127890001	250	250	F10	1	629,67
127895001	300	300	F12	1	966,34

WAFER / LUG GAS

ACCESSORI / RICAMBI - ACCESSORIES / SPARE PARTS

	40	50	65	80	100	125	150	200	250	300
	702335151 € 11,65		702335251 € 11,65		702335401 € 11,65	702335501 € 11,65		702335801 € 20,95		702335901 € 30,53
		117930010 € 48,83			117940010 € 48,83	117960010 € 48,83		117980010 € 92,80	117990010 € 92,80	117995010 € 112,34



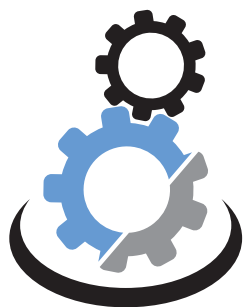

VALVOLE INDUSTRIALI
INDUSTRIAL VALVES
INDUSTRIEKUGELHÄHNE UND VENTILE
VANNES INDUSTRIE
ИНДУСТРИАЛЬНАЯ ЗАПОРНАЯ АРМАТУРА





Valvole inox Stainless steel valves

Valvole a sfera inox AISI 316 - Stainless steel AISI 316 ball valves	p.	243
Accessori inox AISI 316 - Stainless steel AISI 316 accessories	p.	245



Valvole in ghisa Cast iron valves

Valvola a sfera in ghisa attacchi flangiati PN16 - Cast iron ball valve - flanged ends PN16	p.	247
Valvole di ritegno e raccogliatore di impurità in ghisa - Cast iron check valves and strainers	p.	250
Valvola a farfalla in ghisa - Cast iron butterfly valve	p.	251
Accessori/ricambi - Accessories/Spare Parts	p.	252



Valvole industriali con attuatori elettrici Industrial valves with electric actuators

Valvola a sfera in ghisa attacchi flangiati PN16 - Cast iron ball valve - flanged ends PN16	p.	254-259
Valvola a farfalla in ghisa - Cast iron butterfly valve	p.	255-260
Valvole a sfera inox AISI 316 - Stainless steel AISI 316 ball valves	p.	256-261



Valvole industriali con attuatori pneumatici Industrial valves with pneumatic actuators

Valvole a sfera inox AISI 316 - Stainless steel AISI 316 ball valves	p.	270-274
Valvola a sfera in ghisa attacchi flangiati PN16 - Cast iron ball valve - flanged ends PN16	p.	272-277
Valvola a farfalla in ghisa - Cast iron butterfly valve	p.	273-278

INOX

IVR 660



- NOTA: disponibile con filettatura NPT: ultima cifra del codice 5
- NOTE: available with NPT threaded end: the last digit of code is 5
- ANMERKUNG: mit NPT-Gewinde: die letzte Ziffer von der Artikelnummer ist 5
- NOTE: fournisables avec la fixation NPT: la dernière chiffre du numéro de l'article est 5
- ВНИМАНИЕ: доступный с резьбой NPT, последняя цифра кода "5"

Valvola a sfera a passaggio totale in acciaio inox AISI 316 - attacchi F/F
Full bore ball valve in stainless steel AISI 316 - threaded ends F/F
Kugelhahn mit vollem Durchgang aus Edelstahl AISI 316 - IG/IG
Vanne à boisseau sphérique à passage intégral en acier inox AISI 316 - fixations F/F
Полнопроходной шаровой кран из нержавеющей стали AISI 316 - Соединения В/В

Cod./Code	DN	Ø	□/田	€
166002001	1/4"	11,6	20/120	13,02
166003001	3/8"	12,7	15/90	13,02
166005001	1/2"	15	12/72	13,74
166007001	3/4"	20	8/48	19,36
166010001	1"	25	4/24	28,20
166012001	1"1/4	32	9/18	42,28
166015001	1"1/2	40	6/12	57,80
166020001	2"	50	4/8	85,62
166025001	2"1/2	65	1/4	172,63
166030001	3"	76	1/4	232,54
166040001	4"	94	1	429,47



IVR 665



Valvola a sfera a passaggio totale in tre pezzi in acciaio inox AISI 316 - attacchi F/F - flangia ISO 5211
Three-piece full bore ball valve in stainless steel AISI 316 - threaded ends F/F - ISO 5211 flange
Kugelhahn dreiteilig mit vollem Durchgang aus Edelstahl AISI 316 - IG/IG - Flansch ISO 5211
Vanne à boisseau sphérique à passage intégral en trois pièces en acier inox AISI 316 - fixations F/F - bride ISO 5211
Трёхсоставной полнопроходной шаровой кран из нержавеющей стали AISI 316 - Соединения В/В - фланец ISO 5211

Cod./Code	DN	Ø	ISO 5211	□/田	€
166502001	1/4"	11	F03	10/60	22,92
166503001	3/8"	12,7	F03	10/60	22,92
166505001	1/2"	15	F03/F04	8/48	25,03
166507001	3/4"	20	F04/F05	4/24	37,33
166510001	1"	25	F04/F05	3/18	47,23
166512001	1"1/4	32	F05/F07	4/8	69,42
166515001	1"1/2	40	F05/F07	4/8	91,62
166520001	2"	50	F05/F07	3/6	123,33
166525001	2"1/2	65	F07/F10	1/2	256,85
166530001	3"	80	F07/F10	1/2	377,01
166540001	4"	100	F07/F10	1	576,78



IVR 670



Valvola a sfera a passaggio totale in tre pezzi in acciaio inox AISI 316 - attacchi a saldare - flangia ISO 5211
Three-piece full bore ball valve in stainless steel AISI 316 - Butt weld connections - ISO 5211 flange
Kugelhahn dreiteilig mit vollem Durchgang aus Edelstahl AISI 316 - Schweißenden - Flansch ISO 5211
Vanne à boisseau sphérique à passage intégral en trois pièces en acier inox AISI 316 - fixations F/F - bride ISO 5211
Трёхсоставной полнопроходной шаровой кран из нержавеющей стали AISI 316 - Соединения под приварку - фланец ISO 5211

Cod./Code	DN	Ø	ISO 5211	□/田	€
167002001	1/4"	11	F03	10/60	22,20
167003001	3/8"	12,7	F03	10/60	22,20
167005001	1/2"	15	F03	8/48	24,31
167007001	3/4"	20	F04/F05	4/24	36,28
167010001	1"	25	F04/F05	3/18	46,17
167012001	1"1/4	32	F05/F07	4/8	67,65
167015001	1"1/2	40	F05/F07	4/8	89,51
167020001	2"	50	F05/F07	3/6	120,50
167025001	2"1/2	65	F07/F10	1/2	251,22
167030001	3"	80	F07/F10	1/2	368,89
167040001	4"	100	F07/F10	1	563,71



IVR 672



Valvola a sfera a passaggio totale in tre pezzi in acciaio inox AISI 316 - Attacchi a saldare di tasca - Flangia ISO 5211

Three-piece full bore ball valve in stainless steel AISI 316 - Socked weld connection - ISO 5211 flange

Kugelhahn dreiteilig mit vollem Durchgang aus Edelstahl AISI 316 - Schweißanschlüsse - Flansch ISO 5211

Vanne à boisseau sphérique à passage intégral en trois pièces en acier inox AISI 316 - Fixations à souder de poche - Bride ISO 5211

Трёхсоставной полнопроходной шаровой кран из нержавеющей стали AISI 316 - Соединения под приварку (карман) - фланец ISO 5211

Cod./Code	DN	Ø	ISO 5211	□/田	€
167202001	1/4"	11	F03	10/60	23,59
167203001	3/8"	12,7	F03	10/60	23,59
167205001	1/2"	15	F03/F04	8/48	25,71
167207001	3/4"	20	F04/F05	4/24	38,39
167210001	1"	25	F04/F05	3/18	48,62
167212001	1"1/4	32	F05/F07	4/8	71,54
167215001	1"1/2	40	F05/F07	4/8	94,41
167220001	2"	50	F05/F07	3/6	127,18
167225001	2"1/2	65	F07/F10	1/2	264,97
167230001	3"	80	F07/F10	1/2	388,63
167240001	4"	100	F07/F10	1	594,36



IVR 144 L



Valvola a sfera in acciaio inox AISI 316 tre vie passaggio ridotto - sfera forata a L - attacchi F/F/F - flangia ISO 5211

3-way reduced bore ball valve in stainless steel AISI 316 - Bored ball as L - threaded ends F/F/F - ISO 5211 flange

3-Wege-Kugelhahn aus Edelstahl AISI 316 mit reduziertem Durchgang - Kugel mit L-Bohrung - IG/IG - Flansch ISO 5211

Vanne à boisseau sphérique à passage réduit - sphère percée en L - fixations F/F/F - bride ISO 5211

Трёхходовой шаровой кран из нерж. стали AISI 316 с редуцированным проходом - Проход шара "L" - Соединения В/В/В - фланец ISO 5211

Cod./Code	DN	Ø	ISO 5211	□/田	€
114402001	1/4"	9,5	F03/F04	6/36	51,45
114403001	3/8"	9,5	F03/F04	6/36	51,45
114405001	1/2"	12	F03/F04	6/36	51,45
114407001	3/4"	15	F04/F05	3/18	66,93
114410001	1"	20	F04/F05	2/12	92,30
114412001	1"1/4	25	F05/F07	1/12	159,60
114415001	1"1/2	32	F05/F07	1/6	195,88
114420001	2"	40	F05/F07	1/4	323,44



IVR 145 T



Valvola a sfera in acciaio inox AISI 316 tre vie passaggio ridotto - sfera forata a T - attacchi F/F/F - flangia ISO 5211

3-way reduced bore ball valve in stainless steel AISI 316 - Bored ball as T - threaded ends F/F/F - ISO 5211 flange

3-Wege-Kugelhahn aus Edelstahl AISI 316 mit reduziertem Durchgang - Kugel mit T-Bohrung - IG/IG - Flansch ISO 5211

Vanne à boisseau sphérique en acier inox AISI 316 trois voies passage réduit - sphère percée en T - fixations F/F/F - bride ISO 5211

Трёхходовой шаровой кран из нерж. стали AISI 316 с редуцированным проходом - Проход шара "T" - Соединения В/В/В - фланец ISO 5211

Cod./Code	DN	Ø	ISO 5211	□/田	€
114502001	1/4"	9,5	F03/F04	6/36	51,45
114503001	3/8"	9,5	F03/F04	6/36	51,45
114505001	1/2"	12	F03/F04	6/36	51,45
114507001	3/4"	15	F04/F05	3/18	66,93
114510001	1"	20	F04/F05	2/12	91,96
114512001	1"1/4	25	F05/F07	1/12	158,55
114515001	1"1/2	32	F05/F07	1/6	194,49
114520001	2"	40	F05/F07	1/4	319,21



IVR 685



Valvola a sfera a corpo piatto in acciaio inox AISI 316 - Flangia ISO 5211 e attacchi flangiati PN 16
AISI 316 stainless steel ball valve - ISO 5211 flange - Flanged ends PN16

Kugelhahn mit Flachkörper aus Edelstahl AISI 316 - Flansch ISO 5211 und Flanschanschlüsse PN 16

Vanne à boisseau sphérique à corps plat en acier inox AISI 316 - Bride ISO 5211 et fixations bridées PN 16

Шаровой кран с укороченным корпусом из нержавеющей стали AISI 316 - фланец ISO 5211 - Фланцевое соединение PN 16

Cod./Code	DN	Ø	ISO 5211	□/田	€
168505001	15	15	F03	9/18	59,91
168507001	20	20	F03	8/16	73,27
168510001	25	25	F04/F05	6/12	88,79
168512001	32	32	F04/F05	1/8	109,93
168515001	40	40	F05/F07	1/5	148,70
168520001	50	50	F05/F07	1/4	200,11
168525001	65	65	F07/F10	1/3	302,30
168530001	80	76	F07/F10	1/2	409,05
168540001	100	94	F07/F10	1/2	674,02
168550001	125	125	F10/F12	1	1286,69
168560001	150	150	F10/F12	1	1689,78



IVR 655



Valvola di ritegno in acciaio inox AISI 316 - attacchi F/F

Stainless steel AISI 316 vertical check valve - threaded ends F/F

Rückschlagventil aus Edelstahl AISI 316 - IG/IG

Vanne de retenue en acier inox AISI 316 - fixations F/F

Вертикальный обратный клапан из нержавеющей стали AISI 316 - Соединения В/В

Cod./Code	DN	Ø	□/田	€
165502001	1/4"	8	30/180	14,46
165503001	3/8"	10	30/180	14,46
165505001	1/2"	15	25/150	15,14
165507001	3/4"	20	20/120	19,74
165510001	1"	25	12/72	25,71
165512001	1"1/4	32	8/48	37,33
165515001	1"1/2	38	5/30	51,45
165520001	2"	47	3/18	68,37
165525001	2"1/2	61	5/10	120,83
165530001	3"	75	3/6	179,69
165540001	4"	94	1/3	293,12



IVR 656



Valvola di ritegno a molla interflangia tipo WAFER in acciaio inox AISI 316

Stainless steel AISI 316 single disc WAFER spring check valve

Rückschlagventil mit Scheibenklappe, Typ WAFER aus Edelstahl AISI 316

Vanne de retenue à ressort entre-bride type WAFER en acier inox AISI 316

Пружинный межфланцевый обратный клапан из нержавеющей стали AISI 316 - тип WAFER

Cod./Code	DN	Ø	□/田	€
165605001	15	15	60/360	10,91
165607001	20	20	40/240	12,68
165610001	25	25	25/150	16,91
165612001	32	32	15/90	25,37
165615001	40	40	10/60	34,16
165620001	50	49	4/24	47,90
165625001	65	62	1/14	70,48
165630001	80	75	1/10	100,75
165640001	100	95	1/9	147,26
165650001	125	118	1	305,13
165660001	150	140	1	442,88
165680001	200	185	1	836,41



IVR 687



Valvola di ritegno a clapet senza molla, tipo WAFER in acciaio inox AISI 316
Stainless steel AISI 316 single disc WAFER, swing check valve
Rückschlagventil mit Klappe ohne Feder, Typ WAFER aus Edelstahl AISI 316
Vanne de retenue à clapet sans ressort, type WAFER en acier inox AISI 316
Межфланцевый обратный клапан clapet из нержавеющей стали AISI 316 - без пружины - тип WAFER



Cod./Code	DN	Ø	□/田	€
168712001	32	20	1/25	43,00
168715001	40	25	1/25	49,34
168720001	50	32	1/25	58,85
168725001	65	40	1/25	75,05
168730001	80	54	1/10	88,07
168740001	100	70	1/10	134,96
168750001	125	92	1/10	195,20
168760001	150	114	1/3	239,22
168780001	200	154	1/3	388,63
168790001	250	200	1/2	607,77
168795001	300	230	1/2	981,60

IVR 654



Valvola a clapet a passaggio totale in acciaio inox AISI 316 - attacchi F/F
Full bore check valve in stainless steel AISI 316 - threaded ends F/F
Rückschlagventil bzw. Klappe mit vollem Durchgang aus Edelstahl AISI 316 - IG/IG
Vanne à clapet à passage intégral en acier inox AISI 316 - fixations F/F
Полнопроходной обратный клапан из нержавеющей стали AISI 316 - Соединения В/В



Cod./Code	DN	Ø	□/田	€
165402001	1/4"	10	12/72	19,03
165403001	3/8"	12	12/72	19,03
165405001	1/2"	15	12/72	19,03
165407001	3/4"	20	8/48	23,59
165410001	1"	25	6/36	29,60
165412001	1*1/4	32	4/24	50,40
165415001	1*1/2	40	8/16	62,02
165420001	2"	50	5/10	83,84

IVR 657



Filtro a Y a passaggio totale in acciaio inox AISI 316 - attacchi F/F
Full bore check valve in stainless steel AISI 316 - threaded ends F/F
Y-förmiger Filter mit vollem Durchgang aus Edelstahl AISI 316 - IG/IG
Filtre en Y à passage total en acier inox AISI 316 - fixations F/F
Полнопроходной фильтр "Y" из нержавеющей стали - Соединения В/В



Cod./Code	DN	Ø	□/田	€
165702001	1/4"	10	25/150	12,68
165703001	3/8"	12	25/150	12,68
165705001	1/2"	15	25/150	12,68
165707001	3/4"	20	12/72	17,63
165710001	1"	25	8/48	26,09
165712001	1*1/4	32	14/28	35,22
165715001	1*1/2	40	12/24	44,73
165720001	2"	50	4/8	64,14

GHISA

IVR 77



Valvola a sfera in ghisa GJL 250 - Attacchi flangiati PN 16

Cast iron GJL 250 ball valve - Flanged ends PN 16

Kugelhahn aus Gusseisen GJL 250 - Flanschanschlüsse PN 16

Vanne à boisseau sphérique en fonte GJL 250 - Fixations bridées PN 16

Шаровой кран из чугуна GJL 250 - Фланцевое соединение PN 16

Cod./Code	DN	Ø	ISO 5211	□/田	€
107707051	20	20	F04	10	89,18
107710051	25	25	F04	8	104,99
107712051	32	32	F04	5	111,90
107715051	40	40	F05	5	119,81
107720051	50	50	F05	3	131,35
107725051	65	61	F07	2	209,47
107730051	80	74	F07	2	249,60
107740051	100	95	F07	1	289,22
107750011	125	120	F10	1	570,79
107760011	150	145	F10	1	760,65
107780001	200	200	-	1	1705,18

Per le valvole DN 250 prezzo su richiesta / For DN 250 valves price on request

DN 250 Preis auf Anfrage / DN 250 prix sur demande / Для клапанов DN 250 цена по запросу



IVR 77 + IVR 180



IVR 77 - Valvola flangiata in ghisa GJL 250 - Attacchi flangiati PN 16 + IVR 180 - Riduttore di manovra manuale

IVR 77 - Cast iron GJL 250 ball valve - Flanged ends PN 16 + IVR 180 - Manual gear box

IVR 77 - Flansch-Kugelhahn aus Gusseisen GJL 250 - Flanschanschlüsse PN 16 + IVR 180 - Manuelles Getriebe

IVR 77 - Vanne bride en fonte GJL 250 - Fixations bridées PN 16 + IVR 180 - Réducteur de manoeuvre manuelle

IVR 77 - Шаровой кран из чугуна GJL 250 - Фланцевое соединение PN 16 + IVR 180 - Ручной редуктор управления

Cod./Code	DN	Ø	ISO 5211	□/田	€
407715070	40	40	F05	1	248,96
407720070	50	50	F05	1	260,51
407725070	65	61	F07	1	336,80
407730070	80	74	F07	1	376,93
407740070	100	95	F07	1	416,60
407750070	125	120	F10	1	728,76
407760070	150	145	F10	1	918,62



IVR 78



Valvola a sfera in ghisa GJL 250 - asta e sfera inox - Attacchi flangiati PN 16

Cast iron GJL 250 ball valve - Inox stem and ball - Flanged ends PN 16

Kugelhahn aus Gusseisen GJL 250 - Stab und Kugel aus Edelstahl - Flanschanschlüsse PN 16

Vanne à boisseau sphérique en fonte GJL 250 - tige et sphère inox - fixations bridées PN 16

Шаровой кран из чугуна GJL 250 - Шток и шар из нержавеющей стали - Фланцевое соединение PN 16

Cod./Code	DN	Ø	ISO 5211	□/田	€
107807051	20	20	F04	10	86,19
107810051	25	25	F04	8	121,34
107812051	32	32	F04	5	129,73
107815051	40	40	F05	5	155,11
107820051	50	50	F05	3	173,54
107825051	65	61	F07	2	242,63
107830051	80	74	F07	2	303,95
107840051	100	95	F07	1	379,05
107850011	125	120	F10	1	710,57
107860011	150	145	F10	1	1017,74

Per le valvole DN 250 prezzo su richiesta / For DN 250 valves price on request

DN 250 Preis auf Anfrage / DN 250 prix sur demande / Для клапанов DN 250 цена по запросу



IVR 78 + IVR 180



IVR 78 Valvola flangiata in ghisa GJL 250 - Asta e sfera inox - Attacco PN 16
+ IVR 180 Riduttore di manovra manuale

IVR 78 - Cast iron GJL 250 ball valve - Stainless steel stem and ball - Flanged ends PN 16
+ IVR 180 - Manual gearbox

IVR 78 Flansch-Kugelhahn aus Gusseisen GJL 250 - Stab und Kugel aus Edelstahl - Anschluss
+ IVR 180 Manuelles Getriebe

IVR 78 Vanne bride en fonte GJL 250 - tige et sphère inox - fixation PN 16
+ IVR 180 Réducteur de manœuvre manuelle





IVR 78 - Шаровый кран из чугуна GJL 250 - Шток и шар из нержавеющей стали - Фланцевое
соединение PN 16 + IVR 180 - Ручной редуктор управления



Cod./Code	DN	Ø	ISO 5211	□/田	€
407815070	40	40	F05	1	284,26
407820070	50	05	F05	1	302,69
407825070	65	61	F07	1	369,96
407830070	80	74	F07	1	431,28
407840070	100	95	F07	1	506,43
407850070	125	120	F10	1	868,54
407860070	150	145	F10	1	1175,71

77 / 78

ACCESSORI / RICAMBI - ACCESSORIES / SPARE PARTS

	20	25	32	40	50	65	80	100	125	150	200
		702022001 € 1,99		702032001 € 2,67		702052001 € 4,27			702062001 € 13,74		229080400 € 20,77
		750720601 € 1,10		750730801 € 2,92		750740801 € 2,32			750751001 € 3,19		750601001 € 0,60
				118020010 € 96,45		118030010 € 96,45			118050010 € 136,60		
		109710100 € 21,31		109715100 € 70,07		109725100 € 135,95			109740100 € 274,43		
	334205071 € 4,15	334205101 € 4,59	334205121 € 5,16	334205151 € 6,06	334205201 € 6,04	334205251 € 9,04	334205301 € 17,31	334205401 € 17,20	334205501 € 63,65	334205601 € 104,32	334205801 € 151,31



IVR 80



Valvola a sfera a corpo piatto in ghisa GJL 250 - Attacchi flangiati PN16
Cast iron GJL 250 ball valve - Flanged ends PN16
Kugelhahn mit Flachkörper aus Gusseisen GJL 250 - Flanschanschlüsse PN16
Vanne à boisseau sphérique à corps plat en fonte GJL 250 - Fixations bridées PN16
Шаровой кран с укороченным корпусом из чугуна GJL 250 - Фланцевое соединение PN 16

Cod./Code	DN	Ø	□/田	€
108007001	20	20	10	99,38
108010001	25	25	10	133,13
108012001	32	32	8	83,37
108015001	40	40	6	94,97
108020001	50	50	5	107,66
108025001	65	61	3	145,61
108030001	80	74	2	186,08
108040001	100	95	2	245,32



IVR 81



Valvola a sfera a corpo piatto in ghisa GJL 250 - Attacchi flangiati PN16 - Sfera inox
Cast iron GJL 250 ball valve - Flanged ends PN16 - Inox ball
Kugelhahn mit Flachkörper aus Gusseisen GJL 250 - Flanschanschlüsse PN16 - Edelstahlkugel
Vanne à boisseau sphérique à corps plat en fonte GJL 250 - Fixations bridées PN16 - Sphère inox
Шаровой кран с укороченным корпусом из чугуна GJL 250 - Фланцевое соединение PN 16 - шар из нержавеющей стали

Cod./Code	DN	Ø	□/田	€
108107001	20	20	10	123,75
108110001	25	25	10	135,00
108112001	32	32	8	85,47
108115001	40	40	6	98,91
108120001	50	50	5	118,16
108125001	65	61	3	159,19
108130001	80	74	2	222,33
108140001	100	95	2	307,08



80 / 81

ACCESSORI / RICAMBI - ACCESSORIES / SPARE PARTS

	32	40	50	65	80	100
		701031501 € 2,07			701041501 € 5,32	701051501 € 7,52
			750600801 € 0,64			750601001 € 0,60
		109715001 € 8,36			109720001 € 15,64	109725001 € 30,65
	334207121 € 4,51	334207151 € 4,22	334207201 € 4,13	334207251 € 7,25	334207301 € 9,02	334207401 € 16,81



IVR 170



Valvola di ritegno a clapet - in ghisa GJS 500 - Attacchi flangiati PN 16
Swing check valve - Cast iron GJS 500 - Flanged ends PN 16
Rückschlagventil bzw. Klappen- aus Gusseisen GJS 500 - Flanschanschlüsse PN 16
Vanne de retenue à clapet - en fonte GJS 500 - Fixations bridées PN 16
Обратный клапан из чугуна GJS 500 - Фланцевое соединение PN 16

ERC

Cod./Code	DN	Ø	□/田	€
117020020	50	50	1	89,76
117025020	65	65	1	107,39
117030020	80	80	1	134,70
117040020	100	100	1	174,23
117050020	125	125	1	227,38
117060020	150	150	1	294,98
117080020	200	200	1	425,42
117090020	250	250	1	764,54
117095020	300	300	1	1036,44

IVR 172



Filtro a Y con spurgo - in ghisa GJS 500 - Attacchi flangiati PN 16
Y strainer with drain - Cast iron GJS 500 - Flanged ends PN 16
Y- förmiger Filter mit Ablauf (Entleerung)- aus Gusseisen GJS 500 - Flanschanschlüsse PN 16
Filtre en Y avec purge - en fonte GJS 500 - Fixations bridées PN 16
Фильтр осадочный Y с дренажным отверстием - Чугунный GJS 500 - Фланцевое соединение PN 16

ERC

Cod./Code	DN	Ø	□/田	€
117220020	50	50	1	64,18
117225020	65	65	1	89,34
117230020	80	80	1	107,98
117240020	100	100	1	151,40
117250020	125	125	1	217,23
117260020	150	150	1	330,16
117280020	200	200	1	482,96
117290020	250	250	1	993,40
117295020	300	300	1	1309,31

IVR 342



Valvola in ghisa a doppia reg. con prese di pressione in DZR (non montate), ad orifizio variabile, flangiata PN16 (EN1092-2). Condizioni di esercizio: da -10° C a +120° C
Cast iron double setting valve with test points in DZR brass (unmounted), variable orifice, Flangiata PN16 (EN1092-2). Working conditions: -10° C to +120° C
Ventil aus Gusseisen - DoppelEinstellung mit DZR Drucksteckdose (nicht eingebaut), mit Variable Öffnung, Flansch PN16 (EN 1092-2). Betriebstemperatur: -10° C to +120° C
Vanne d'équilibrage statique en fonte, avec prises de pression pas montée, orifice variable, pourvue de brides PN16 (EN1092-2). Conditions de travail: -10° C à + 120° C
Чугунный клапан с двойной регулировкой, вставки для контроля из латуни DZR (не установлены), фланцы PN16 (EN1092-2). Рабочая температура: от -10° C до +120° C

Cod./Code	Misura/Size	□/田	€
134225001	dn 65	1	429,00
134230001	dn 80	1	622,88
134240001	dn 100	1	853,88
134250001	dn 125	1	1175,63
134260001	dn 150	1	1460,25
134280001	dn 200	1	2582,25
134290001	dn 250	1	3778,50
134295001	dn 300	1	6971,25



IVR 175



Valvola a farfalla in ghisa tipo LUG - Attacchi flangiati PN16
Cast iron butterfly valve LUG type - Flanged ends PN16
Ventil mit Flügelgriff aus Gusseisen Typ LUG - Flanschanschlüsse PN16
Vanne papillon en fonte type LUG - fixations bridées PN 16
Дисковый затвор «Баттерфляй» из чугуна - тип LUG - Фланцевое соединение PN 16



Cod./Code	DN	Ø	ISO5211	□/田	€
117515001	40	40	F05	1/8	45,28
117520001	50	50	F05	1/4	47,86
117525001	65	65	F05	1/3	53,69
117530001	80	80	F05	1/2	60,50
117540001	100	100	F07	1/2	91,49
117550001	125	125	F07	1	118,30
117560001	150	150	F07	1	140,24

IVR 176



Valvola a farfalla in ghisa tipo WAFER - Attacchi flangiati PN16
Cast iron butterfly valve WAFER type - Flanged ends PN16
Ventil mit Flügelgriff aus Gusseisen Typ WAFER - Flanschanschlüsse PN16
Vanne papillon en fonte type WAFER - Fixations bridées PN16
Дисковый затвор «Баттерфляй» из чугуна - тип WAFFER - Фланцевое соединение PN 16



Cod./Code	DN	Ø	ISO5211	□/田	€
117615001	40	40	F05	1/8	38,98
117620001	50	50	F05	1/8	41,22
117625001	65	65	F05	1/4	49,26
117630001	80	80	F05	1/4	53,40
117640001	100	100	F07	1/2	72,00
117650001	125	125	F07	1	96,90
117660001	150	150	F07	1	112,67
117680001	200	200	F10	1	181,34
117690001	250	250	F10	1	261,50
117695001	300	300	F12	1	383,18

IVR 276 CF8M



Valvola a farfalla in ghisa tipo WAFER - attacchi flangiati PN16 - Disco Inox CF8M
Cast iron butterfly valve WAFER type - flanged ends PN16 - stainless steel CF8M disc
Ventil mit Flügelgriff aus Gusseisen Typ WAFER - Flanschanschlüsse PN16 - mit Scheibe aus rostfreiem Stahl CF8M
Vanne papillon en fonte type WAFER - fixations bridées PN16 - disque en acier inoxydable CF8M
Дисковый затвор «Баттерфляй» из чугуна - тип WAFER - фланцевое соединение PN 16 - диск из нержавеющей стали CF8M



Cod./Code	DN	Ø	ISO5211	□/田	€
127615001	40	40	F05	1/8	55,85
127620001	50	50	F05	1/4	59,06
127625001	65	65	F05	1/3	71,58
127630001	80	80	F05	1/2	82,11
127640001	100	100	F07	1/2	122,74
127650001	125	125	F07	1	170,94
127660001	150	150	F07	1	217,44
127680001	200	200	F10	1	358,57
127690001	250	250	F10	1	619,48
127695001	300	300	F12	1	949,47

WAFER / LUG

ACCESSORI / RICAMBI - ACCESSORIES / SPARE PARTS

	40	50	65	80	100	125	150	200	250	300
	702320151 € 11,65		702320251 € 11,65		702320401 € 11,65	702320501 € 11,65		702320801 € 20,95		702320901 € 30,53
		117930010 € 48,83			117940010 € 48,83	117960010 € 48,83		117980010 € 92,80	117990010 € 92,80	117995010 € 112,34



IVR 174



Valvola di ritegno a doppio battente interflangia, in ghisa, tipo WAFER
Cast iron dual plate check valve, WAFER type
Rückschlagventil mit doppelter Scheibenklappe, aus Gusseisen, Typ WAFER
Vanne de retenue à double battant entre-bride, en fonte, type WAFER
Двустворчатый межфланцевый обратный клапан из чугуна - тип WAFER



Cod./Code	DN	Ø	□/田	€
117420001	50	43,3	1/10	42,45
117425001	65	60,2	1/10	54,24
117430001	80	66,4	1/5	65,83
117440001	100	84	1/5	80,37
117450001	125	112,6	1/2	106,46
117460001	150	132	1/2	144,64
117480001	200	175	1	245,64
117490001	250	216	1	338,36
117495001	300	250	1	542,66

ACCIAIO

IVR 653



Valvola di ritegno a clapet senza molla tipo WAFER in acciaio al carbonio galvanizzato
Galvanized carbon steel single disc WAFER swing check valve
Rückschlagventil bzw. Klappen ohne Feder Typ WAFER aus galvanisiertem C-Stahl
Vanne de retenue à clapet sans ressort type WAFER en acier au carbone galvanisé
Межфланцевый обратный клапан из гальванизированной углеродистой стали - без пружины - тип WAFER



Cod./Code	DN	Ø	□/田	€
165315001	40	20	1	41,69
165320001	50	25	1	49,72
165325001	65	38	1	64,14
165330001	80	46	1	81,05
165340001	100	71	1	119,78
165350001	125	95	1	137,03
165360001	150	114	1	179,26
165380001	200	140	1	278,49
165390001	250	188	1	463,04
165395001	300	216	1	739,64

IVR 697



Giunto antivibrante flangiato - PN16
Flanged rubber flexible joint - PN16
Schwingungsgedämpfter Flanschanschluss - PN16
Joint antivibration bridé - PN16
Фланцевая антивибрационная вставка - PN16



Cod./Code	DN	□/田	€
169712001	32	1/8	31,33
169715001	40	1/8	34,50
169720001	50	1/5	37,80
169725001	65	1/4	51,67
169730001	80	1/3	63,33
169740001	100	1/2	77,20
169750001	125	1/2	105,40
169760001	150	1	139,18
169780001	200	1	223,15
169790001	250	1	337,47
169795001	300	1	402,92



IVR 696



Giunto antivibrante filettato - PN10
Threaded rubber flexible vibration-free joint - PN10
Schwingungsgedämpfter Gewindeanschluss - PN10
Joint antivibration fileté - PN10
Резьбовая антивибрационная вставка - PN10

Cod./Code	DN	Ø	□/田	€
169607001	20	3/4"	1/20	15,56
169610001	25	1"	1/20	17,04
169612001	32	1-1/4"	1/20	19,62
169615001	40	1-1/2"	1/10	24,82
169620001	50	2"	1/10	30,48
169625001	65	2-1/2"	1/5	40,29
169630001	80	3"	1/4	56,82

EAC

ACCESSORI / RICAMBI
ACCESSORIES / PARTS
ZUBEHÖR / ERSATZTEILE
ACCESSOIRES / PIÈCES
АКСЕССУАРЫ / ЗАПЧАСТИ

IVR 172 G



Guarnizione o-ring per vite spurgo e coperchio filtro a Y in ghisa (per IVR 172)
O-ring for drain bolt and bonnet for Y strainer (for IVR 172)
O-Ring für Ablassschraube und Deckel für Y-Filter aus Gusseisen (für IVR 172)
Joint O-ring pour vis de purge et couvercle de filtre en Y en fonte (pour IVR 172)
Уплотнительное O - кольцо для дренажного болта и крышки фильтра Y из чугуна (для IVR 172)

Cod./Code	DN	□/田	€
334143021	DN 50-80 OR spurgo 18x2,4	1	0,15
334143041	DN 100-300 OR spurgo 24x3,1	1	0,30
334143201	DN 50 OR coperchio 75x4,0	1	0,76
334143251	DN 65 OR coperchio 90x4,0	1	0,96
334143301	DN 80 OR coperchio 110x4,0	1	1,07
334143401	DN 100 OR coperchio 130x5,7	1	1,26
334143501	DN 125 OR coperchio 150x5,7	1	1,53
334143601	DN 150 OR coperchio 180x5,7	1	1,80
334143801	DN 200 OR coperchio 215x5,7	1	2,14
334143901	DN 250 OR coperchio 310x5,7	1	2,75
334143951	DN 300 OR coperchio 350x5,7	1	3,06

IVR 172 C



Cestello inox per filtro a Y in ghisa (per IVR 172)
Screen for Y strainer in stainless steel (for IVR 172)
Edelstahlkäfig für Y-förmigen Filter aus Gusseisen (für IVR 172)
Panier inox pour filtre en Y en fonte (pour IVR 172)
Корзина из нержавеющей стали для фильтра Y из чугуна (для IVR 172)

Cod./Code	DN	□/田	€
334142201	DN 50 cestello inox 1	1	4,24
334142251	DN 65 cestello inox 1	1	6,73
334142301	DN 80 cestello inox 1	1	8,72
334142401	DN 100 cestello inox 1	1	12,01
334142501	DN 125 cestello inox 1	1	16,02
334142601	DN 150 cestello inox 1	1	27,26
334142801	DN 200 cestello inox 1	1	41,18
334142901	DN 250 cestello inox 1	1	79,11
334142951	DN 300 cestello inox 1	1	101,55



VALVOLE INDUSTRIALI CON ATTUATORI ELETTRICI
INDUSTRIAL VALVES WITH ELECTRIC ACTUATORS
INDUSTRIEVENTILE MIT ANTRIEBEN ELEKTRISCH
VANNES INDUSTRIELLES AVEC ACTUATEURS ÉLECTRIQUE
ИНДУСТРИАЛЬНАЯ ЗАПОРНАЯ АРМАТУРА С ЭЛЕКТРИЧЕСКИМИ ПРИВОДАМИ

In accordo alle Direttive Europee
According to European Directive
89/336/EEC
73/23/EEC
EN 61000-6-2: 2001
EN 61000-6-4: 2001
EN 61010-6: 1995

IVR 77 + IVR 272 M



IVR 77 - Valvola flangiata in ghisa GJL 250 - attacchi flangiati PN16 +
IVR 272 - MH - attuatori elettrici a 1/4 di giro - 230 V - 50 Hz - monofase c.a.
IVR 77 - Cast iron GJL 250 ball valve - flanged ends PN16 +
IVR 272 - MH - electrical quarter-turn actuators - 230 V - 50 Hz - 1-phase a.c.
IVR 77 - Flansch-Kugelhahn aus Gusseisen GJL 250 - Flanschanschlüsse PN16 +
IVR 272 - MH - elektrische Antriebe mit 1/4-Umdrehung - 230 V - 50 Hz - einphasiger Wechselstrom
IVR 77 - Vanne bride en fonte GJL 250 - fixations bridées PN16 +
IVR 272 - MH - actuateurs électriques à 1/4 de tour - 230 V - 50 Hz - monophasé c.a.
IVR 77 - Шаровой кран из чугуна GJL 250 - Фланцевое соединение PN16 +
IVR 272 - MH - электроприводы на 1/4 оборота - 230 V - 50 Hz - однофазный переменный ток.

Cod./Code	Misura/Size	□/田	€
407707412	IVR 77 DN 20 + MH-R25/12	1	650,59
407710412	IVR 77 DN 25 + MH-R25/12	1	666,40
407712428	IVR 77 DN 32 + MH-R45/30	1	673,31
407715428	IVR 77 DN 40 + MH-R45/30	1	739,18
407720467	IVR 77 DN 50 + MH-Q67/32	1	749,85
407725467	IVR 77 DN 65 + MH-Q67/32	1	1437,07
407730509	IVR 77 DN 80 + MH-Q102/32	1	1593,44
407740509	IVR 77 DN 100 + MH-Q102/32	1	1631,15
407750528	IVR 77 DN 125 + MH-Q202/69	1	2214,28
407760528	IVR 77 DN 150 + MH-Q202/69	1	2403,49



IVR 78 + IVR 272 M



IVR 78 - Valvola flangiata in ghisa GJL 250 - asta e sfera inox - attacchi flangiati PN16 +
IVR 272 - MH - attuatori elettrici a 1/4 di giro - 230 V - 50 Hz - monofase c.a.
IVR 78 - Cast iron GJL 250 ball valve - inox stem and ball - flanged ends PN16 +
IVR 272 - MH - electrical quarter-turn actuators - 230 V - 50 Hz - 1-phase a.c.
IVR 78 - Flansch-Kugelhahn aus Gusseisen GJL 250 - Stab und Kugel aus Edelstahl -
Flanschanschlüsse PN16 +
IVR 272 - MH - elektrische Antriebe mit 1/4-Umdrehung - 230 V - 50 Hz - einphasiger Wechselstrom
IVR 78 - Vanne bride en fonte GJS 400 - tige et sphère inox - fixations bridées PN16 +
IVR 272 - MH - actuateurs électriques à 1/4 de tour - 230 V - 50 Hz - monophasé c.a.
IVR 78 - Шаровой кран из чугуна GJL 250 - шток и шар из нержавеющей стали - Фланцевое
соединение PN16 +
IVR 272 - MH - электроприводы на 1/4 оборота - 230 V - 50 Hz - однофазный переменный ток

Cod./Code	Misura/Size	□/田	€
407807412	IVR 78 DN 20 + MH-R25/12	1	647,58
407810412	IVR 78 DN 25 + MH-R25/12	1	682,73
407812428	IVR 78 DN 32 + MH-R45/30	1	691,12
407815428	IVR 78 DN 40 + MH-R45/30	1	774,48
407820467	IVR 78 DN 50 + MH-Q67/32	1	792,03
407825467	IVR 78 DN 65 + MH-Q67/32	1	1470,23
407830509	IVR 78 DN 80 + MH-Q102/32	1	1647,80
407840509	IVR 78 DN 100 + MH-Q102/32	1	1720,98
407850528	IVR 78 DN 125 + MH-Q202/69	1	2354,07
407860528	IVR 78 DN 150 + MH-Q202/69	1	2660,58



IVR 175 + IVR 272 M



IVR 175 - Valvola a farfalla in ghisa tipo LUG - attacchi flangiati PN16 +
IVR 272 - MH - attuatori elettrici a 1/4 di giro - 230 V - 50 Hz - monofase c.a.
IVR 175 - Butterfly valve LUG type - flanged ends PN16 +
IVR 272 - MH - electrical quarter-turn actuators - 230 V - 50 Hz - 1-phase a.c.
IVR 175 - Ventil mit Flügelgriff aus Gusseisen Typ LUG - Flanschanschlüsse PN16 +
IVR 272 - MH - elektrische Antriebe mit 1/4-Umdrehung - 230 V - 50 Hz - einphasiger Wechselstrom
IVR 175 - Vanne papillon en fonte type LUG - fixations bridées PN16 +
IVR 272 - MH - actuateurs électriques à 1/4 de tour - 230 V - 50 Hz - monophasé c.a.
IVR 175 - Дисковый затвор «Баттерфляй» из чугуна - тип LUG - Фланцевое соединение PN 16 +
IVR 272 - MH - электроприводы на 1/4 оборота - 230 V - 50 Hz - однофазный переменный ток

Cod./Code	Misura/Size	□/田	€
417515428	IVR 175 DN 40 + MH-R45/30	1	685,85
417520428	IVR 175 DN 50 + MH-R45/30	1	688,19
417525428	IVR 175 DN 65 + MH-R45/30	1	693,46
417530428	IVR 175 DN 80 + MH-R45/30	1	761,08
417540467	IVR 175 DN 100 + MH-Q67/32	1	782,66
417550509	IVR 175 DN 125 + MH-Q102/32	1	1497,05
417560509	IVR 175 DN 150 + MH-Q102/32	1	1517,07



IVR 176 + IVR 272 M



IVR 176 - Valvola a farfalla in ghisa tipo WAFER - attacchi flangiati PN16 +
IVR 272 - MH - attuatori elettrici a 1/4 di giro - 230 V - 50 Hz - monofase c.a.
IVR 176 - Butterfly valve WAFER type - flanged ends PN16 +
IVR 272 - MH - electrical quarter-turn actuators - 230 V - 50 Hz - 1-phase a.c.
IVR 176 - Ventil mit Flügelgriff aus Gusseisen Typ WAFER - Flanschanschlüsse PN16 +
IVR 272 - MH - elektrische Antriebe mit 1/4-Umdrehung - 230 V - 50 Hz - einphasiger Wechselstrom
IVR 176 - Vanne papillon en fonte type WAFER - fixations bridées PN16 +
IVR 272 - MH - actuateurs électriques à 1/4 de tour - 230 V - 50 Hz - monophasé c.a.
IVR 176 - Дисковый затвор «Баттерфляй» из чугуна - тип WAFER - Фланцевое соединение PN 16 +
IVR 272 - MH - электроприводы на 1/4 оборота - 230 V - 50 Hz - однофазный переменный ток

Cod./Code	Misura/Size	□/田	€
417615428	IVR 176 DN 40 + MH-R45/30	1	680,16
417620428	IVR 176 DN 50 + MH-R45/30	1	682,18
417625428	IVR 176 DN 65 + MH-R45/30	1	689,45
417630428	IVR 176 DN 80 + MH-R45/30	1	754,66
417640467	IVR 176 DN 100 + MH-Q67/32	1	765,03
417650509	IVR 176 DN 125 + MH-Q102/32	1	1477,70
417660509	IVR 176 DN 150 + MH-Q102/32	1	1492,14
417680528	IVR 176 DN 200 + MH-Q202/69	1	1876,73
417690547	IVR 176 DN 250 + MH-Q502/93	1	2392,76
417695567	IVR 176 DN 300 + MH-Q702/93	1	2638,04



IVR 276 CF8M + IVR 272 M



IVR 276 CF8M - Valvola a farfalla in ghisa tipo WAFER - disco inox - attacchi flangiati PN16 +
IVR 272 - MH - attuatori elettrici a 1/4 di giro - 230 V - 50 Hz - monofase c.a.
IVR 276 CF8M - Butterfly valve WAFER type - stainless steel disc - flanged ends PN16 +
IVR 272 - MH - electrical quarter-turn actuators - 230 V - 50 Hz - 1-phase a.c.
IVR 276 CF8M - Ventil mit Flügelgriff aus Gusseisen Typ WAFER - Edelstahlsscheibe -
Flanschanschlüsse PN16 +
IVR 272 - MH - elektrische Antriebe mit 1/4-Umdrehung - 230 V - 50 Hz - einphasiger Wechselstrom
IVR 276 CF8M - Vanne papillon en fonte type WAFER - disque inox - fixations bridées PN16 +
IVR 272 - MH - actuateurs électriques à 1/4 de tour - 230 V - 50 Hz - monophasé c.a.
IVR 276 CF8M - Дисковый затвор «Баттерфляй» из чугуна - тип WAFER - диск из нержавеющей
стали - Фланцевое соединение PN 16 +
IVR 272 - MH - электроприводы на 1/4 оборота - 230 V - 50 Hz - однофазный переменный ток

Cod./Code	Misura/Size	□/田	€
427615428	IVR 276 CF8M DN 40 + MH-R45/30	1	695,41
427620428	IVR 276 CF8M DN 50 + MH-R45/30	1	698,32
427625428	IVR 276 CF8M DN 65 + MH-R45/30	1	709,64
427630428	IVR 276 CF8M DN 80 + MH-R45/30	1	780,62
427640467	IVR 276 CF8M DN 100 + MH-Q67/32	1	810,91
427650509	IVR 276 CF8M DN 125 + MH-Q102/32	1	1544,65
427660509	IVR 276 CF8M DN 150 + MH-Q102/32	1	1586,88
427680528	IVR 276 CF8M DN 200 + MH-Q202/69	1	2037,02
427690547	IVR 276 CF8M DN 250 + MH-Q502/93	1	2716,50
427695567	IVR 276 CF8M DN 300 + MH-Q702/93	1	3150,17



IVR 665 + IVR 272 M



IVR 665 - Valvola a sfera in tre pezzi in acciaio inox - attacchi F/F - flangia ISO 5211 +
IVR 272 - MH - attuatori elettrici a 1/4 di giro - 230 V - 50 Hz - monofase c.a.

IVR 665 - Three-piece ball valve in stainless steel- threaded ends F/F - ISO 5211 flange +
IVR 272 - MH - electrical quarter-turn actuators - 230 V - 50 Hz - 1-phase a.c.

IVR 665 - Kugelhahn, dreiteilig, aus Edelstahl - IG/IG - Flansch ISO 5211 +
IVR 272 - MH - elektrische Antriebe mit 1/4-Umdrehung - 230 V - 50 Hz - einphasiger Wechselstrom

IVR 665 - Vanne à boisseau sphérique en trois pièces en acier inox - fixations F/F - bride ISO 5211 +
IVR 272 - MH - actionneurs électriques à 1/4 de tour - 230 V - 50 Hz - monophasé c.a.

IVR 665 - трёхсоставной шаровой кран из нержавеющей стали - соединения В/В - фланец ISO 5211 +
IVR 272 - MH - электроприводы на 1/4 оборота - 230 V - 50 Hz - однофазный переменный ток



Cod./Code	Misura/Size	□/田	€
466502412	IVR 665 DN 1/4" + MH-R25/12	1	596,37
466503412	IVR 665 DN 3/8" + MH-R25/12	1	596,37
466505412	IVR 665 DN 1/2" + MH-R25/12	1	598,24
466507412	IVR 665 DN 3/4" + MH-R25/12	1	609,15
466510412	IVR 665 DN 1" + MH-R25/12	1	617,93
466512412	IVR 665 DN 1"1/4" + MH-R25/12	1	637,62
466515428	IVR 665 DN 1"1/2" + MH-R45/30	1	717,30
466520428	IVR 665 DN 2" + MH-R45/30	1	745,43
466525488	IVR 665 DN 2"1/2" + MH-RQ77/60	1	1475,10
466530509	IVR 665 DN 3" + MH-Q102/32	1	1697,93
466540509	IVR 665 DN 4" + MH-Q102/32	1	1875,12

IVR 670 + IVR 272 M



IVR 670 - Valvola a sfera in tre pezzi in acciaio inox - attacchi a saldare - flangia ISO 5211 +
IVR 272 - MH - attuatori elettrici a 1/4 di giro - 230 V - 50 Hz - monofase c.a.

IVR 670 - Three-piece ball valve in stainless steel- butt weld connections - ISO 5211 flange +
IVR 272 - MH - electrical quarter-turn actuators - 230 V - 50 Hz - 1-phase a.c.

IVR 670 - Kugelhahn, dreiteilig, aus Edelstahl - Schweissenden- Flansch ISO 5211 +
IVR 272 - MH - elektrische Antriebe mit 1/4-Umdrehung - 230 V - 50 Hz - einphasiger Wechselstrom

IVR 670 - Vanne à boisseau sphérique en trois pièces en acier inox - fixations à souder- bride ISO 5211 +
IVR 272 - MH - actionneurs électriques à 1/4 de tour - 230 V - 50 Hz - monophasé c.a.

IVR 670 - трёхсоставной шаровой кран из нержавеющей стали - соединения под приварку -
фланец ISO 5211 +

IVR 272 - MH - электроприводы на 1/4 оборота - 230 V - 50 Hz - однофазный переменный ток



Cod./Code	Misura/Size	□/田	€
467002412	IVR 670 DN 1/4" + MH-R25/12	1	595,73
467003412	IVR 670 DN 3/8" + MH-R25/12	1	595,73
467005412	IVR 670 DN 1/2" + MH-R25/12	1	597,60
467007412	IVR 670 DN 3/4" + MH-R25/12	1	608,22
467010412	IVR 670 DN 1" + MH-R25/12	1	616,99
467012412	IVR 670 DN 1"1/4" + MH-R25/12	1	636,04
467015428	IVR 670 DN 1"1/2" + MH-R45/30	1	715,43
467020428	IVR 670 DN 2" + MH-R45/30	1	757,48
467025488	IVR 670 DN 2"1/2" + MH-Q77/60	1	1498,94
467030509	IVR 670 DN 3" + MH-Q102/32	1	1723,88
467040509	IVR 670 DN 4" + MH-Q102/32	1	1900,07

IVR 672 + IVR 272 M



IVR 672 - Valvola a sfera a passaggio totale in tre pezzi in acciaio inox AISI 316 - attacchi a saldare di tasca - flangia ISO 5211 +

IVR 272 - MH - attuatori elettrici a 1/4 di giro - 230 V - 50 Hz - monofase c.a.

IVR 672 - Three-piece ball valve in stainless steel- socked weld connections - ISO 5211 flange +

IVR 272 - MH - electrical quarter-turn actuators - 230 V - 50 Hz - 1-phase a.c.

IVR 672 - Kugelhahn dreiteilig mit vollem Durchgang aus Edelstahl AISI 316 - Schweißanschlüsse - Flansch ISO 5211 +

IVR 272 - MH - elektrische Antriebe mit 1/4-Umdrehung - 230 V - 50 Hz - einphasiger Wechselstrom

IVR 672 - Vanne à boisseau sphérique à passage intégral en trois pièces en acier inox AISI 316 - fixations à souder de poche - bride ISO 5211 +

IVR 272 - MH - actionneurs électriques à 1/4 de tour - 230 V - 50 Hz - monophasé c.a.

IVR 672 - трёхсоставной шаровой кран из нержавеющей стали AISI 316 - соединение под приварку (карман) - фланец ISO 5211 +

IVR 272 - MH - электроприводы на 1/4 оборота - 230 V - 50 Hz - однофазный переменный ток

Cod./Code	Misura/Size	□/田	€
467202412	IVR 672 DN 1/4" + MH-R25/12	1	596,97
467203412	IVR 672 DN 3/8" + MH-R25/12	1	596,97
467205412	IVR 672 DN 1/2" + MH-R25/12	1	598,84
467207412	IVR 672 DN 3/4" + MH-R25/12	1	610,09
467210412	IVR 672 DN 1" + MH-R25/12	1	619,17
467212412	IVR 672 DN 1 1/4" + MH-R25/12	1	639,49
467215428	IVR 672 DN 1 1/2" + MH-R45/30	1	719,78
467220428	IVR 672 DN 2" + MH-R45/30	1	763,52
467225488	IVR 672 DN 2 1/2" + MH-Q77/60	1	1511,37
467230509	IVR 672 DN 3" + MH-Q102/32	1	1741,74
467240509	IVR 672 DN 4" + MH-Q102/32	1	1927,79



IVR 144 L + IVR 272 M



IVR 144L - Valvola a sfera a passaggio ridotto a tre vie in acciaio inox AISI 316 - sfera forata a L- attacchi F/F/F - flangia ISO 5211 +

IVR 272 - MH - attuatori elettrici a 1/4 di giro - 230 V - 50 Hz - monofase c.a.

IVR 144L - 3-way reduce bore ball valve in stainless steel AISI 316 - bored ball as L - threaded ends F/F/F - ISO 5211 flange +

IVR 272 - MH - electrical quarter-turn actuators - 230 V - 50 Hz - 1-phase a.c.

IVR 144L - 3-Wege-Kugelhahn mit reduziertem Durchgang aus Edelstahl AISI 316 - Kugel mit L-Bohrung-IG/IG/IG - Flansch ISO 5211 +

IVR 272 - MH - elektrische Antriebe mit 1/4-Umdrehung - 230 V - 50 Hz - einphasiger Wechselstrom

IVR 144L - Vanne à boisseau sphérique à passage réduit à trois voies en acier inox AISI 316 - sphère percée en L - fixations F/F/F - bride ISO 5211 +

IVR 272 - MH - actionneurs électriques à 1/4 de tour - 230 V - 50 Hz - monophasé c.a.

IVR 144L - трёхходовый шаровой кран из нержавеющей стали AISI 316 с редуцированным проходом - проход шара L - соединения В/В/В - фланец ISO 5211 +

IVR 272 - MH - электроприводы на 1/4 оборота - 230 V - 50 Hz - однофазный переменный ток

Cod./Code	Misura/Size	□/田	€
414402412	IVR 144L DN 1/4" + MH-R-E 25/17	1	621,68
414403412	IVR 144L DN 3/8" + MH-R-E 25/17	1	621,68
414405412	IVR 144L DN 1/2" + MH-R-E 25/17	1	621,68
414407412	IVR 144L DN 3/4" + MH-R-E 25/17	1	635,40
414410412	IVR 144L DN 1" + MH-R-E 25/17	1	657,90
414412428	IVR 144L DN 1 1/4" + MH-R-E 50/33	1	777,60
414415428	IVR 144L DN 1 1/2" + MH-R-E 50/33	1	809,78
414420509	IVR 144L DN 2" + MH-Q 102/32	1	1650,42



IVR 145 T + IVR 272 M



IVR 145T - Valvola a sfera a passaggio ridotto a tre vie in acciaio inox AISI 316 - sfera forata a T - attacchi F/F/F - flangia ISO 5211 +

IVR 272 - MH - attuatori elettrici a 1/4 di giro - 230 V - 50 Hz - monofase c.a.

IVR 145T - Three-piece reduce bore ball valve in stainless steel AISI 316 - bored ball as T - threaded ends F/F/F - ISO 5211 flange +

IVR 272 - MH - electrical quarter-turn actuators - 230 V - 50 Hz - 1-phase a.c.

IVR 145T - 3-Wege-Kugelhahn mit reduziertem Durchgang aus Edelstahl AISI 316 - Kugel mit T-Bohrung-IG/IG/IG - Flansch ISO 5211 +

IVR 272 - MH - elektrische Antriebe mit 1/4-Umdrehung - 230 V - 50 Hz - einphasiger Wechselstrom

IVR 145T - Vanne à boisseau sphérique à passage réduit à trois voies en acier inox AISI 316 - sphère percée en T - fixations F/F/F - bride ISO 5211 +

IVR 272 - MH - actionneurs électriques à 1/4 de tour - 230 V - 50 Hz - monophasé c.a.

IVR 145T - трёхходовый шаровой кран из нержавеющей стали AISI 316 с редуцированным проходом - проход шара Т - соединения В/В/В - фланец ISO 5211 +

IVR 272 - MH - электроприводы на 1/4 оборота - 230 V - 50 Hz - однофазный переменный ток



Cod./Code	Misura/Size	□/田	€
414502412	IVR 145T DN 1/4" + MH-R-E 25/17	1	621,68
414503412	IVR 145T DN 3/8" + MH-R-E 25/17	1	621,68
414505412	IVR 145T DN 1/2" + MH-R-E 25/17	1	621,68
414507412	IVR 145T DN 3/4" + MH-R-E 25/17	1	635,40
414510412	IVR 145T DN 1" + MH-R-E 25/17	1	657,60
414512428	IVR 145T DN 1"1/4 + MH-R-E 50/33	1	776,67
414515428	IVR 145T DN 1"1/2 + MH-R-E 50/33	1	808,54
414520509	IVR 145T DN 2" + MH-Q 102/32	1	1646,67

IVR 685 + IVR 272 M



IVR 685 - Valvola a sfera a corpo piatto flangiata in acciaio inox - flangia ISO 5211 - attacchi flangiati PN16 +

IVR 272 - MH - attuatori elettrici a 1/4 di giro - 230 V - 50 Hz - monofase c.a.

IVR 685 - WAFER flanged ball valve PN16 - stainless steel - ISO 5211 flange +

IVR 272 - MH - electrical quarter-turn actuators - 230 V - 50 Hz - 1-phase a.c.

IVR 685 - Kugelhahn mit flachem, angeflanshtem Körper aus Edelstahl - Flansch ISO 5211 - Flanschanschlüsse PN16 +

IVR 272 - MH - elektrische Antriebe mit 1/4-Umdrehung - 230 V - 50 Hz - einphasiger Wechselstrom

IVR 685 - Vanne à boisseau sphérique à corps plat bride en acier inox - bride ISO 5211 - fixations bridées PN16 +

IVR 272 - MH - actionneurs électriques à 1/4 de tour - 230 V - 50 Hz - monophasé c.a.

IVR 685 - шаровой кран с укороченным корпусом из нержавеющей стали - фланец ISO 5211 - фланцевое соединение PN16 +

IVR 272 - MH - электроприводы на 1/4 оборота - 230 V - 50 Hz - однофазный переменный ток



Cod./Code	Misura/Size	□/田	€
468505412	IVR 685 DN 15 + MH-R-E 25/17	1	629,18
468507412	IVR 685 DN 20 + MH-R-E 25/17	1	641,03
468510412	IVR 685 DN 25 + MH-R-E 25/17	1	654,79
468512412	IVR 685 DN 32 + MH-R-E 25/17	1	673,54
468515428	IVR 685 DN 40 + MH-R-E 50/33	1	767,93
468520428	IVR 685 DN 50 + MH-R-E 50/33	1	813,53
468525509	IVR 685 DN 65 + MH-Q 102/32	1	1631,67
468530528	IVR 685 DN 80 + MH-Q 202/69	1	2082,29
468540528	IVR 685 DN 100 + MH-Q 202/69	1	2321,91



IVR 77 + IVR 272 T



IVR 77 - Valvola flangiata in ghisa GJL 250 - attacchi flangiati PN16 +
IVR 272 - MH - attuatori elettrici a 1/4 di giro - 400 V - 50 Hz - trifase c.a.

IVR 77 - Cast iron GJL 250 ball valve - flanged ends PN16 +
IVR 272 - MH - electrical quarter-turn actuators - 400 V - 50 Hz - 3-phase a.c.

IVR 77 - Flanschkuhnhahn aus Gusseisen GJL 250 - Flanschanschlüsse PN16 +
IVR 272 - MH - elektrische Antriebe mit 1/4-Umdrehung - 400 V - 50 Hz - dreiphasiger Wechselstrom

IVR 77 - Vanne bride en fonte GJL 250 - fixations bridées PN16 +
IVR 272 - MH - actuateurs électriques à 1/4 de tour - 400 V - 50 Hz - triphasé c.a.

IVR 77 - Шаровой кран из чугуна GJL 250 - Фланцевое соединение PN16 +
PN16IVR 272 - MH - электроприводы на 1/4 оборота - 400 V - 50 Hz - трехфазный переменный ток

Cod./Code	Misura/Size	□/田	€
407707429	IVR 77 DN 20 + MH-R 45/5	1	1115,59
407710429	IVR 77 DN 25 + MH-R 45/5	1	1131,40
407712429	IVR 77 DN 32 + MH-R 45/5	1	1138,31
407715429	IVR 77 DN 40 + MH-R 45/5	1	1144,18
407720470	IVR 77 DN 50 + MH-Q 67/32	1	1413,60
407725470	IVR 77 DN 65 + MH-Q 67/32	1	1489,57
407730512	IVR 77 DN 80 + MH-Q 102/32	1	1600,94
407740512	IVR 77 DN 100 + MH-Q 102/32	1	1638,65
407750530	IVR 77 DN 125 + MH-Q 202/69	1	2233,03
407760530	IVR 77 DN 150 + MH-Q 202/69	1	2422,24



IVR 78 + IVR 272 T



IVR 78 - Valvola flangiata in ghisa GJL 250 - asta e sfera inox - attacchi flangiati PN16 +
IVR 272 - MH - attuatori elettrici a 1/4 di giro - 400 V - 50 Hz - trifase c.a.

IVR 78 - Cast iron GJL 250 ball valve - inox stem and ball - flanged ends PN16 +
IVR 272 - MH - electrical quarter-turn actuators - 400 V - 50 Hz - 3-phase a.c.

IVR 78 - Flanschkuhnhahn aus Gusseisen GJL 250 - Stab und Kugel aus Edelstahl - Flanschanschlüsse PN16 +
IVR 272 - MH - elektrische Antriebe mit 1/4-Umdrehung - 400 V - 50 Hz - dreiphasiger Wechselstrom

IVR 78 - Vanne bride en fonte GJL 250 - tige et sphère inox - fixations bridées PN16 +
IVR 272 - MH - actuateurs électriques à 1/4 de tour - 400 V - 50 Hz - triphasé c.a.

IVR 78 - Шаровой кран из чугуна GJL 250 - шток и шар из нержавеющей стали - Фланцевое
соединение PN16 +
PN16IVR 272 - MH - электроприводы на 1/4 оборота - 400 V - 50 Hz - трехфазный переменный ток

Cod./Code	Misura/Size	□/田	€
407807429	IVR 78 DN 20 + MH-R 45/5	1	1112,58
407810429	IVR 78 DN 25 + MH-R 45/5	1	1132,02
407812429	IVR 78 DN 32 + MH-R 45/5	1	1156,12
407815429	IVR 78 DN 40 + MH-R 45/5	1	1179,48
407820470	IVR 78 DN 50 + MH-Q 67/32	1	1455,78
407825470	IVR 78 DN 65 + MH-Q 67/32	1	1522,73
407830512	IVR 78 DN 80 + MH-Q 102/32	1	1655,30
407840512	IVR 78 DN 100 + MH-Q 102/32	1	1728,48
407850530	IVR 78 DN 125 + MH-Q 202/69	1	2372,82
407860530	IVR 78 DN 150 + MH-Q 202/69	1	2679,33



IVR 175 + IVR 272 T



IVR 175 - Valvola a farfalla in ghisa tipo LUG - attacchi flangiati PN16 +
IVR 272 - MH - attuatori elettrici a 1/4 di giro - 400 V - 50 Hz - monofase c.a.

IVR 175 - Butterfly valve LUG type - flanged ends PN16 +
IVR 272 - MH - electrical quarter-turn actuators - 400 V - 50 Hz - 1-phase a.c.

IVR 175 - Ventil mit Flügelgriff aus Gusseisen Typ LUG - Flanschanschlüsse PN16 +
IVR 272 - MH - elektrische Antriebe mit 1/4-Umdrehung - 400 V - 50 Hz - einphasiger Wechselstrom

IVR 175 - Vanne papillon en fonte type LUG - fixations bridées PN16 +
IVR 272 - MH - actuateurs électriques à 1/4 de tour - 400 V - 50 Hz - monophasé c.a.

IVR 175 - Дискový затвор «Баттерфляй» из чугуна - тип LUG - Фланцевое соединение PN 16 +
IVR 272 - MH - электроприводы на 1/4 оборота - 400 V - 50 Hz - однофазный переменный ток

Cod./Code	Misura/Size	□/田	€
417515470	IVR 175 DN 40 + MH-Q 67/32	1	1372,18
417520470	IVR 175 DN 50 + MH-Q 67/32	1	1374,51
417525470	IVR 175 DN 65 + MH-Q 67/32	1	1379,79
417530470	IVR 175 DN 80 + MH-Q 67/32	1	1386,23
417540470	IVR 175 DN 100 + MH-Q 67/32	1	1407,81
417550512	IVR 175 DN 125 + MH-Q 102/32	1	1504,69
417560512	IVR 175 DN 150 + MH-Q 102/32	1	1524,71



IVR 176 + IVR 272 T



IVR 176 - Valvola a farfalla in ghisa tipo WAFER - attacchi flangiati PN16 +
IVR 272 - MH - attuatori elettrici a 1/4 di giro - 400 V - 50 Hz - trifase c.a.

IVR 176 - Butterfly valve WAFER type - flanged ends PN16 +
IVR 272 - MH - electrical quarter-turn actuators - 400 V - 50 Hz - 3-phase a.c.

IVR 176 - Ventil mit Flügelgriff aus Gusseisen Typ WAFER - Flanschanschlüsse PN16 +
IVR 272 - MH - elektrische Antriebe mit 1/4-Umdrehung - 400 V - 50 Hz - dreiphasiger Wechselstrom

IVR 176 - Vanne papillon en fonte type WAFER - fixations bridées PN16 +
IVR 272 - MH - actuateurs électriques à 1/4 de tour - 400 V - 50 Hz - triphasé c.a.

IVR 176 - Дискový затвор «Баттерфляй» из чугуна - тип WAFER - Фланцевое соединение PN 16 +
IVR 272 - MH - электроприводы на 1/4 оборота - 400 V - 50 Hz - трехфазный переменный ток

Cod./Code	Misura/Size	□/田	€
417615470	IVR 176 DN 40 + MH-Q 67/32	1	1366,48
417620470	IVR 176 DN 50 + MH-Q 67/32	1	1368,51
417625470	IVR 176 DN 65 + MH-Q 67/32	1	1375,77
417630470	IVR 176 DN 80 + MH-Q 67/32	1	1379,80
417640470	IVR 176 DN 100 + MH-Q 67/32	1	1390,18
417650512	IVR 176 DN 125 + MH-Q 102/32	1	1485,35
417660512	IVR 176 DN 150 + MH-Q 102/32	1	1499,78
417680530	IVR 176 DN 200 + MH-Q 202/69	1	1895,85
417690550	IVR 176 DN 250 + MH-Q 502/93	1	2392,76
417695570	IVR 176 DN 300 + MH-Q 702/93	1	2638,04



IVR 276 CF8M + IVR 272 T



IVR 276 CF8M - Valvola a farfalla in ghisa tipo WAFER - disco inox - attacchi flangiati PN16 +
IVR 272 - MH - attuatori elettrici a 1/4 di giro - 400 V - 50 Hz - trifase c.a.

IVR 276 CF8M - Butterfly valve WAFER type - stainless steel disc - flanged ends PN16 +
IVR 272 - MH - electrical quarter-turn actuators - 400 V - 50 Hz - 1-phase a.c.

IVR 276 CF8M - Ventil mit Flügelgriff aus Gusseisen Typ WAFER - Edelstahlsscheibe - Flanschanschlüsse PN16 +
IVR 272 - MH - elektrische Antriebe mit 1/4-Umdrehung - 400 V - 50 Hz - dreiphasiger Wechselstrom

IVR 276 CF8M - Vanne papillon en fonte type WAFER - disque inox - fixations bridées PN16 +
IVR 272 - MH - actuateurs électriques à 1/4 de tour - 400 V - 50 Hz - monophasé c.a.

IVR 276 CF8M - Дискový затвор «Баттерфляй» из чугуна - тип WAFER - диск из нержавеющей стали -
Фланцевое соединение PN 16 +
IVR 272 - MH - электроприводы на 1/4 оборота - 400 V - 50 Hz - трёхфазный переменный ток

Cod./Code	Misura/Size	□/田	€
427615470	IVR 276 CF8M DN 40 + MH-Q 67/32	1	1381,74
427620470	IVR 276 CF8M DN 50 + MH-Q 67/32	1	1384,64
427625470	IVR 276 CF8M DN 65 + MH-Q 67/32	1	1395,96
427630470	IVR 276 CF8M DN 80 + MH-Q 67/32	1	1405,77
427640470	IVR 276 CF8M DN 100 + MH-Q 67/32	1	1436,06
427650512	IVR 276 CF8M DN 125 + MH-Q 102/32	1	1552,30
427660512	IVR 276 CF8M DN 150 + MH-Q 102/32	1	1594,53
427680530	IVR 276 CF8M DN 200 + MH-Q 202/69	1	2056,13
427690550	IVR 276 CF8M DN 250 + MH-Q 502/93	1	2716,50
427695570	IVR 276 CF8M DN 300 + MH-Q 702/93	1	3150,17



IVR 665 + IVR 272 T



IVR 665 - Valvola a sfera in tre pezzi in acciaio inox - attacchi F/F - flangia ISO 5211 +
IVR 272 - MH - attuatori elettrici a 1/4 di giro - 400 V - 50 Hz - monofase c.a.

IVR 665 - Three-piece ball valve in stainless steel- threaded ends F/F - ISO 5211 flange +
IVR 272 - MH - electrical quarter-turn actuators - 400 V - 50 Hz - 1-phase a.c.

IVR 665 - Kugelhahn, dreiteilig, aus Edelstahl - IG/IG- Flansch ISO 5211 +
IVR 272 - MH - elektrische Antriebe mit 1/4-Umdrehung - 400 V - 50 Hz - dreiphasiger Wechselstrom

IVR 665 - Vanne à boisseau sphérique en trois pièces en acier inox - fixations F/F - bride ISO 5211 +
IVR 272 - MH - actuateurs électriques à 1/4 de tour - 400 V - 50 Hz - monophasé c.a.

IVR 665 - трёхсоставной шаровой кран из нержавеющей стали - соединения В/В - фланец ISO 5211 +
IVR 272 - MH - электроприводы на 1/4 оборота - 400 V - 50 Hz - однофазный переменный ток



Cod./Code	Misura/Size	□/田	€
466502429	IVR 665 DN 1/4" + MH-R 45/5	1	1060,81
466503429	IVR 665 DN 3/8" + MH-R 45/5	1	1060,81
466505429	IVR 665 DN 1/2" + MH-R 45/5	1	1062,69
466507429	IVR 665 DN 3/4" + MH-R 45/5	1	1073,60
466510429	IVR 665 DN 1" + MH-R 45/5	1	1082,37
466512429	IVR 665 DN 1"1/4" + MH-R 45/5	1	1102,06
466515429	IVR 665 DN 1"1/2" + MH-R 45/5	1	1121,75
466520429	IVR 665 DN 2" + MH-R 45/5	1	1149,87
466525512	IVR 665 DN 2"1/2" + MH-Q 102/32	1	1598,30
466530512	IVR 665 DN 3" + MH-Q 102/32	1	1704,87
466540512	IVR 665 DN 4" + MH-Q 102/32	1	1882,06

IVR 670 + IVR 272 T



IVR 670 - Valvola a sfera in tre pezzi in acciaio inox - attacchi a saldare - flangia ISO 5211 +
IVR 272 - MH - attuatori elettrici a 1/4 di giro - 400 V - 50 Hz - trifase c.a.

IVR 670 - Three-piece ball valve in stainless steel- butt weld connections - ISO 5211 flange +
IVR 272 - MH - electrical quarter-turn actuators - 400 V - 50 Hz - 1-phase a.c.

IVR 670 - Kugelhahn, dreiteilig, aus Edelstahl - Schweissenden- Flansch ISO 5211 +
IVR 272 - MH - elektrische Antriebe mit 1/4-Umdrehung - 400 V - 50 Hz - dreiphasiger Wechselstrom

IVR 670 - Vanne à boisseau sphérique en trois pièces en acier inox - fixations à souder - bride ISO 5211 +
IVR 272 - MH - actuateurs électriques à 1/4 de tour - 400 V - 50 Hz - triphasé c.a.

IVR 670 - трёхсоставной шаровой кран из нержавеющей стали - соединения под приварку -
фланец ISO 5211 +
IVR 272 - MH - электроприводы на 1/4 оборота - 400 V - 50 Hz - трехфазный переменный ток



Cod./Code	Misura/Size	□/田	€
467002429	IVR 670 DN 1/4" + MH-R 45/5	1	1060,17
467003429	IVR 670 DN 3/8" + MH-R 45/5	1	1060,17
467005429	IVR 670 DN 1/2" + MH-R 45/5	1	1062,05
467007429	IVR 670 DN 3/4" + MH-R 45/5	1	1072,66
467010429	IVR 670 DN 1" + MH-R 45/5	1	1081,44
467012429	IVR 670 DN 1"1/4" + MH-R 45/5	1	1100,49
467015429	IVR 670 DN 1"1/2" + MH-R 45/5	1	1119,87
467020429	IVR 670 DN 2" + MH-R 45/5	1	1169,86
467025512	IVR 670 DN 2"1/2" + MH-Q 102/32	1	1624,55
467030512	IVR 670 DN 3" + MH-Q 102/32	1	1730,96
467040512	IVR 670 DN 4" + MH-Q 102/32	1	1907,15



IVR 672 + IVR 272 T



IVR 672 - Valvola a sfera in tre pezzi in acciaio inox - attacchi a saldare di tasca - flangia ISO 5211 +
IVR 272 - MH - attuatori elettrici a 1/4 di giro - 400 V - 50 Hz - trifase c.a.

IVR 672 - Three-piece ball valve in stainless steel- socked weld connections - ISO 5211 flange +
IVR 272 - MH - electrical quarter-turn actuators - 400 V - 50 Hz - 3-phase a.c.

IVR 672 - Kugelhahn, dreiteilig, aus Edelstahl - Schweißanschlüsse - Flansch ISO 5211 +
IVR 272 - MH - elektrische Antriebe mit 1/4-Umdrehung - 400 V - 50 Hz - dreiphasiger Wechselstrom

IVR 672 - Vanne à boisseau sphérique en trois pièces en acier inox - fixations à souder de poche - bride
ISO 5211 PN16 +

IVR 272 - MH - actuateurs électriques à 1/4 de tour - 400 V - 50 Hz - triphasé c.a.

IVR 672 - трёхсоставной шаровой кран из нержавеющей стали AISI 316 - соединение под
приварку (карман) - фланец ISO 5211 +

IVR 272 - MH - электроприводы на 1/4 оборота - 400 V - 50 Hz - трехфазный переменный ток



Cod./Code	Misura/Size	□/田	€
467202429	IVR 672 DN 1/4" + MH-R 45/5	1	1061,41
467203429	IVR 672 DN 3/8" + MH-R 45/5	1	1061,41
467205429	IVR 672 DN 1/2" + MH-R 45/5	1	1063,29
467207429	IVR 672 DN 3/4" + MH-R 45/5	1	1074,54
467210429	IVR 672 DN 1" + MH-R 45/5	1	1083,61
467212429	IVR 672 DN 1"1/4" + MH-R 45/5	1	1103,94
467215429	IVR 672 DN 1"1/2" + MH-R 45/5	1	1124,22
467220429	IVR 672 DN 2" + MH-R 45/5	1	1175,90
467225512	IVR 672 DN 2"1/2 + MH-Q 102/32	1	1636,98
467230512	IVR 672 DN 3" + MH-Q 102/32	1	1748,82
467240512	IVR 672 DN 4" + MH-Q 102/32	1	1934,87

IVR 144 L + IVR 272 T



IVR 144L - Valvola a sfera a passaggio ridotto a tre vie in acciaio inox AISI 316 - sfera forata a Lattacchi
F/F/F - flangia ISO 5211 +

IVR 272 - MH - attuatori elettrici a 1/4 di giro - 400 V - 50 Hz - trifase c.a.

IVR 144L - 3-way reduce bore ball valve in stainless steel AISI 316 - bored ball as L - threaded ends
F/F/F - ISO 5211 flange +

IVR 272 - MH - electrical quarter-turn actuators - 400 V - 50 Hz - 3-phase a.c.

IVR 144L - 3-Wege-Kugelhahn mit reduziertem Durchgang aus Edelstahl AISI 316 - Kugel mit L-Bohrung
IG/IG/IG - Flansch ISO 5211 +

IVR 272 - MH - elektrische Antriebe mit 1/4-Umdrehung - 400 V - 50 Hz - dreiphasiger Wechselstrom

IVR 144L - Vanne à boisseau sphérique à passage réduit à trois voies en acier inox AISI 316 - sphère
percée en L - fixations F/F/F - bride ISO 5211 +

IVR 272 - MH - actuateurs électriques à 1/4 de tour - 400 V - 50 Hz - triphasé c.a.

IVR 144L - трёхходовый шаровой кран из нержавеющей стали AISI 316 с редуцированным проходом
- проход шара L - соединения В/В/В - фланец ISO 5211 +

IVR 272 - MH - электроприводы на 1/4 оборота - 400 V - 50 Hz - трёхфазный переменный ток



Cod./Code	Misura/Size	□/田	€
414402429	IVR 144L DN 1/4" + MH-R 45/5	1	1086,36
414403429	IVR 144L DN 3/8" + MH-R 45/5	1	1086,36
414405429	IVR 144L DN 1/2" + MH-R 45/5	1	1086,36
414407429	IVR 144L DN 3/4" + MH-R 45/5	1	1100,09
414410429	IVR 144L DN 1" + MH-R 45/5	1	1122,59
414412429	IVR 144L DN 1"1/4 + MH-R 45/5	1	1182,29
414415429	IVR 144L DN 1"1/2 + MH-R 45/5	1	1214,46
414420512	IVR 144L DN 2" + MH-Q 102/32	1	1657,71

IVR 145 T + IVR 272 T



IVR 145T - Valvola a sfera a passaggio ridotto a tre vie in acciaio inox AISI 316 - sfera forata a T - attacchi F/F/F - flangia ISO 5211 +

IVR 272 - MH - attuatori elettrici a 1/4 di giro - 400 V - 50 Hz - trifase c.a.

IVR 145T - 3-way reduced bore ball valve in stainless steel AISI 316 - bored ball as T - threaded ends F/F/F - ISO 5211 flange +

IVR 272 - MH - electrical quarter-turn actuators - 400 V - 50 Hz - 3-phase a.c.

IVR 145T - 3-Wege-Kugelhahn mit reduziertem Durchgang aus Edelstahl AISI 316 - Kugel mit T-Bohrung IG/IG/IG - Flansch ISO 5211 +

IVR 272 - MH - elektrische Antriebe mit 1/4-Umdrehung - 400 V - 50 Hz - dreiphasiger Wechselstrom

IVR 145T - Vanne à boisseau sphérique à passage réduit à trois voies en acier inox AISI 316 - sphère percée en L - fixations F/F/F - bride ISO 5211 +

IVR 272 - MH - actuateurs électriques à 1/4 de tour - 400 V - 50 Hz - triphasé c.a.

IVR 145T - трёхходовый шаровой кран из нержавеющей стали AISI 316 с редуцированным проходом - проход шара T - соединения В/В/В - фланец ISO 5211 +

IVR 272 - MH - электроприводы на 1/4 оборота - 400 V - 50 Hz - трёхфазный переменный ток

Cod./Code	Misura/Size	□/田	€
414502429	IVR 145T DN 1/4" + MH-R 45/5	1	1086,36
414503429	IVR 145T DN 3/8" + MH-R 45/5	1	1086,36
414505429	IVR 145T DN 1/2" + MH-R 45/5	1	1086,36
414507429	IVR 145T DN 3/4" + MH-R 45/5	1	1100,09
414510429	IVR 145T DN 1" + MH-R 45/5	1	1122,29
414512429	IVR 145T DN 1"1/4 + MH-R 45/5	1	1181,35
414515429	IVR 145T DN 1"1/2 + MH-R 45/5	1	1213,23
414520512	IVR 145T DN 2" + MH-Q 102/32	1	1653,96



IVR 685 + IVR 272 T



IVR 685 - Valvola a sfera a corpo piatto flangiata in acciaio inox - flangia ISO 5211 - attacchi flangiati PN16 +

IVR 272 - MH - attuatori elettrici a 1/4 di giro - 400 V - 50 Hz - trifase c.a.

IVR 685 - WAFER flanged ball valve PN16 - stainless steel - ISO 5211 flange +

IVR 272 - MH - electrical quarter-turn actuators - 400 V - 50 Hz - 3-phase a.c.

IVR 685 - Kugelhahn mit flachem, angeflanschem Körper aus Edelstahl - Flansch ISO 5211

-Flanschanschlüsse PN16 +

IVR 272 - MH - elektrische Antriebe mit 1/4-Umdrehung - 400 V - 50 Hz - dreiphasiger Wechselstrom

IVR 685 - Vanne à boisseau sphérique à corps plat bride en acier inox - bride ISO 5211 - fixations

bridées PN16 +

IVR 272 - MH - actuateurs électriques à 1/4 de tour - 400 V - 50 Hz - triphasé c.a.

IVR 685 - шаровой кран с укороченным корпусом из нержавеющей стали AISI 316 - фланец ISO

5211 - фланцевое соединение PN16 +

IVR 272 - MH - электроприводы на 1/4 оборота - 400 V - 50 Hz - трехфазный переменный ток

Cod./Code	Misura/Size	□/田	€
468505429	IVR 685 DN 15 + MH-R 45/5	1	1093,62
468507429	IVR 685 DN 20 + MH-R 45/5	1	1105,47
468510429	IVR 685 DN 25 + MH-R 45/5	1	1119,24
468512429	IVR 685 DN 32 + MH-R 45/5	1	1137,99
468515429	IVR 685 DN 40 + MH-R 45/5	1	1172,37
468520429	IVR 685 DN 50 + MH-R45/5	1	1217,97
468525512	IVR 685 DN 65 + MH-Q 102/32	1	1638,61
468530530	IVR 685 DN 80 + MH-Q 202/69	1	2100,85
468540530	IVR 685 DN 100 + MH-Q 202/69	1	2341,03



IVR 665 / IVR 670 / IVR 672 + IVR 218



IVR 665 / 670 / 672 - Valvola a sfera in tre pezzi in acciaio inox - attacchi F/F (665) o attacchi a saldare (670) o attacchi a saldare di testa (672) - flangia ISO 5211 - monofase c.a. +
IVR 218 Motorhead F03 / F04 - bidirezionale 230 V - senza relé - 3 punti

IVR 665 / 670 / 672 - Three-piece ball valve in stainless steel- threaded ends F/F (665) or butt weld connections (670) or socket weld connections (672) - ISO 5211 flange - 1-phase a.c. +
IVR 218 Motorhead F03 / F04 - dual-directional 230 V - without relay - 3 contact terminals

IVR 665 / 670 / 672 - Kugelhahn, dreiteilig, aus Edelstahl - IG/IG (665), Schweissenden (670) oder Stumpfschweißenden (672) - Flansch ISO 5211- einphasiger Wechselstrom +
IVR 218 Motorhead F03 / F04 - bidirektional 230 V - ohne Relais - 3-Punkt-Steuerung

IVR 665 / 670 / 672 - Vanne à boisseau sphérique en trois pièces en acier inox - fixations F/F (665) ou fixations à souder (670) ou fixations à souder de tête (672) - bride ISO 5211 - monophasé c.a. +
IVR 218 Motorhead F03 / F04 - bidirectionnel 230 V - sans relais - 3 points

IVR 665 / 670 / 672 - трёхсоставной шаровой кран из нержавеющей стали - соединения В/В (665), или соединения под приварку (670), или соединения под приварку встык (672) - фланец ISO 5211 - однофазный переменный ток +
IVR 218 Motorhead F03 / F04 - двухпозиционный 230 V - без реле- 3 контактных зажима

Cod./Code	Misura/Size	□/田	€
466502250	IVR 665 DN 1/4" + MH 218 F03 B 230 V sr	1	184,42
466503250	IVR 665 DN 3/8" + MH 218 F03 B 230 V sr	1	184,42
466505250	IVR 665 DN 1/2" + MH 218 F03 B 230 V sr	1	186,30
466507268	IVR 665 DN 3/4" + MH 218 F04 B 230 V sr	1	220,83
466510268	IVR 665 DN 1" + MH 218 F04 B 230 V sr	1	230,16
467002250	IVR 670 DN 1/4" + MH 218 F03 B 230 V sr	1	183,54
467003250	IVR 670 DN 3/8" + MH 218 F03 B 230 V sr	1	183,54
467005250	IVR 670 DN 1/2" + MH 218 F03 B 230 V sr	1	185,42
467007268	IVR 670 DN 3/4" + MH 218 F04 B 230 V sr	1	219,66
467010268	IVR 670 DN 1" + MH 218 F04 B 230 V sr	1	228,43
467202250	IVR 672 DN 1/4" + MH 218 F03 B 230 V sr	1	184,78
467203250	IVR 672 DN 3/8" + MH 218 F03 B 230 V sr	1	184,78
467205250	IVR 672DN 1/2" + MH 218 F03 B 230 V sr	1	186,66
467207268	IVR 672 DN 3/4" + MH 218 F04 B 230 V sr	1	221,53
467210268	IVR 672DN 1" + MH 218 F04 B 230 V sr	1	230,61



IVR 144 L / IVR 145 T + IVR 218



IVR 144L/145T - Valvola a sfera a passaggio ridotto a tre vie in acciaio inox AISI 316 - sfera forata a L (144L) o sfera forata T (145T) - attac. F/F/F - flangia ISO 5211 - monofase c.a. +
IVR 218 Motorhead F03 / F04 - bidirezionale 230 V - senza relé - 3 punti

IVR 144L/145T - 3-way reduced bore ball valve in s. steel AISI 316 - bored ball as L (144L) or bored ball as T (145T) - threaded ends F/F/F - ISO 5211 flange - 1-phase a.c. +
IVR 218 Motorhead F03 / F04 - dual-directional 230 V - without relay - 3 contact terminals

IVR 144L/145T - 3-Wege-Kugelhahn mit reduziertem Durchgang aus Edelstahl AISI 316 - Kugel mit L-Bohrung (144L) oder T-Bohrung (145T) - IG/IG/IG - Flansch ISO 5211- einphasiger Wechselstrom +
IVR 218 Motorhead F03 / F04 - bidirektional 230 V - ohne Relais - 3-Punkt-Steuerung

IVR 144L/145T - Vanne à boisseau sphérique à passage réduit à trois voies en acier inox AISI 316 - sphère percée en L (144L) ou sphère percée en T (145T) - fix. F/F/F - bride ISO 5211 - monophasé c.a. +
IVR 218 Motorhead F03 / F04 - bidirectionnel 230 V - sans relais - 3 points

IVR 144L/ IVR 145T - трёхходовый шаровой кран из нержавеющей стали AISI 316 с редуцированным проходом - проход шара L (144L), или проход шара T (145T) - соединения В/В/В - фланец ISO 5211 - однофазный переменный ток +
IVR 218 Motorhead F03 / F04 - двухпозиционный 230 V - без реле- 3 контактных зажима

Cod./Code	Misura/Size	□/田	€
414402250	IVR 144L DN 1/4" + MH 218 F03 B 230 V sr	1	209,73
414403250	IVR 144L DN 3/8" + MH 218 F03 B 230 V sr	1	209,73
414405250	IVR 144L DN 1/2" + MH 218 F03 B 230 V sr	1	210,85
414407268	IVR 144L DN 3/4" + MH 218 F04 B 230 V sr	1	247,08
414502250	IVR 145T DN 1/4" + MH 218 F03 B 230 V sr	1	209,73
414503250	IVR 145T DN 3/8" + MH 218 F03 B 230 V sr	1	209,73
414505250	IVR 145T DN 1/2" + MH 218 F03 B 230 V sr	1	209,73
414507268	IVR 145T DN 3/4" + MH 218 F04 B 230 V sr	1	247,08



IVR 685 + IVR 218



IVR 685 - Valvola a sfera a corpo piatto flangiata in acciaio inox - flangia ISO 5211 - attacchi flangiati PN16 - Monofase c.a. +

Motorhead 218 F0304 / F - bidirezionale 230 V - senza relé - 3 punti

IVR 685 - WAFER flanged ball valve PN16 - stainless steel - ISO 5211 flange - 1-phase a.c. + Motorhead 218 F03 / F04 - dual-directional 230 V - without relay - 3 contact terminals

IVR 685 - Kugelhahn mit flachem, angeflanschem Körper aus Edelstahl - Flansch ISO 5211 - Flanschanschlüsse PN16 - einphasiger Wechselstrom + Motorhead 218 F0304 / F - bidirektional 230 V - ohne Relais - 3-Punkt-Steuerung

IVR 685 - Vanne à boisseau sphérique à corps plat bride en acier inox - bride ISO 5211 - fixations bridées PN16 - Monophasé c.a. +

Motorhead 218 F03 / F04 - bidirectionnel 230 V - sans relais - 3 points

IVR 685 - Шаровой кран с укороченным корпусом из нержавеющей стали - фланец ISO 5211 - фланцевое соединение PN16 - однофазный переменный ток +

Motorhead 218 F03 / F04 - двухпозиционный 230 V - без реле- 3 контактных зажима



Cod./Code	Misura/Size	□/田	€
468505250	IVR 685 DN 15 + MH 218 FO3 B 230 V sr	1	216,68
468507250	IVR 685 DN 20 + MH 218 FO3 B 230 V sr	1	228,53
468510268	IVR 685 DN 25 + MH 218 FO4 B 230 V sr	1	265,91



IVR 272 M



MH-R / MH-R-E



MH-Q

IVR 272 - MH - attuatori elettrici a 1/4 di giro - 230 V - 50 Hz - Monofase c.a.
IVR 272 - MH - electrical quarter-turn actuators - 230 V - 50 Hz - 1-phase a.c.
IVR 272 - MH - elektrische Antriebe mit 1/4-Umdrehung - 230 V - 50 Hz - einphasiger Wechselstrom
IVR 272 - actuateurs électriques à 1/4 de tour - 230 V - 50 Hz - Monophasé c.a.
IVR 272 - MH -электроприводы на 1/4 оборота - 230 V - 50 Hz - однофазный переменный ток

Cod./Code	Misura/Size	□/田	€
127210312	MH-R25/12 - 230 V - 50Hz c.a	1	615,00
127210317	MH-R-E25/17 - 230 V - 50/60Hz c.a.	1	566,25
127220330	MH-R45/30 - 230 V - 50Hz c.a	1	660,00
127230333	MH-R-E50/33 - 230 V - 50/60Hz c.a.	1	626,25
127235332	MH-Q67/32 - 230 V - 50Hz c.a	1	1155,00
127240360	MH-Q77/60 - 230 V - 50Hz c.a	1	1155,00
127250332	MH-Q102/32 - 230 V - 50Hz c.a	1	1271,25
127260369	MH-Q202/69 - 230 V - 50Hz c.a	1	1552,50
127275393	MH-Q502/93 - 230 V - 50Hz c.a	1	1950,00
127285393	MH-Q702/93 - 230 V - 50Hz c.a	1	2073,75
127295393	MH-Q1002/93 - 230 V - 50Hz c.a	1	2321,25

24 V - 115 V disponibile su richiesta | Prezzi comprensivi di boccola non lavorata

24 V - 115 V available on request | Price with not machined bush

24 V - 115 V erhältlich auf Anfrage | Preise einschließlich unbearbeiteter Buchse

24 V - 115 V Disponible sur demande | Les prix comprennent une douille non travaillée

24 V - 115 V под заказ | Цена с учётом необработанной втулки

IVR 272 T



MH-R



MH-Q

IVR 272 - MH - Attuatori elettrici a 1/4 di giro - 400 V - 50 Hz - Trifase c.a.
IVR 272 - MH - Electrical quarter-turn actuators - 400 V - 50 Hz - 3-phase a.c.
IVR 272 - MH - elektrische Antriebe mit 1/4-Umdrehung - 400 V - 50 Hz - dreiphasiger Wechselstrom
IVR 272 - MH - Actuateurs électriques à 1/4 de tour - 400 V - 50 Hz - Triphasé c.a.
IVR 272 - MH - электроприводы на 1/4 оборота - 400 V - 50 Hz - трехфазный переменный ток

Cod./Code	Misura/Size	□/田	€
127220405	MH-R45/5 - 400 V - 50Hz c.a	1	948,75
127230422	MH-Q52/22 - 400 V - 50Hz c.a	1	1207,50
127235432	MH-Q67/32 - 400 V - 50Hz c.a	1	1207,50
127250432	MH-Q102/32 - 400 V - 50Hz c.a	1	1278,75
127260469	MH-Q202/69 - 400 V - 50Hz c.a	1	1571,25
127275493	MH-Q502/93 - 400 V - 50Hz c.a	1	1950,00
127285493	MH-Q702/93 - 400 V - 50Hz c.a	1	2073,75
127295493	MH-Q1002/93 - 400 V - 50Hz c.a	1	2321,25

Prezzi comprensivi di boccola non lavorata

Price with not machined bush

Preise einschließlich unbearbeiteter Buchse

Les prix comprennent une douille non travaillée

Цена с учётом необработанной втулки

IVR 218 3P SBLOCCO MANUALE



MOTORHEAD ISO SBLOCCO MANUALE (F03/F04) SERVOCOMANDI per valvole serie AUTOMAT L - ISO 5211 Bidirezionale - comando a 3 punti - 1 micro supplementare libero in apertura di serie

MOTORHEAD ISO (F03/F04) ACTUATORS WITH MANUAL RELEASE for valves series AUTOMAT L - ISO 5211 Dual-directional - 3 contact terminals - 1 auxiliary micro-switch free on opening included

MOTORHEAD ISO MANUELLE ENTRIEGELUNG (F03/F04) SERVOSTEUERUNGEN für Ventile Serie AUTOMAT L - ISO 5211 Bidirektional ohne Relais - 3-Punkt-Steuerung - 1 zusätzlichen Mikroschalter bei Öffnung

MOTORHEAD ISO (F03/F04) ACTUATORS WITH MANUAL RELEASE for valves series AUTOMAT L - ISO 5211 Bidirectionnel sans relais - commande à 3 points - 1 micro supplémentaire

MOTORHEAD ISO СЕРВОПРИВОДЫ С РУЧНЫМ УПРАВЛЕНИЕМ (F03/F04) для клапанов серии AUTOMAT L - ISO 5211 Двухпозиционный без реле- 3 контактных зажима - 1 вспомогательный микровыключатель

comando a 3 punti: un singolo comando può azionare un solo servocomando

3 contact terminals: a single control device can operate only one actuator

3-Punkt-Steuerung: kann nur eine Servosteuerung betätigen

commande à 3 points: peut actionner plusieurs servocommandes

3 контактных зажима: можно подключать только один привод



Cod./Code	ISO 5211	Alim./Power Sup.	Coppia/Torque	Tem./Time	◁	□/田	€
121833520	F03	230V 50/60 Hz	11 Nm	35 sec.	90°	1/8	158,22
121843520	F04	230 V 50 Hz	14 Nm	35 sec.	90°	1/8	181,85

OPZIONI:

- Su richiesta versione con 1 micro switch supplementare

- Su richiesta versione 24V o 110V

Lotto minimo 20 pz.

OPZIONAL:

- Version with 1 auxiliary micro switch on request

- 24V or 110V version on request

Minimum quantity 20 pcs.

OPTIONEN:

- auf Anfrage Version mit 1 zusätzliche Mikro-Switch

- auf Anfrage 24V oder 110V Version

Mindestabnahme 20 Stk

OPTIONS:

- Sur demande version avec 1 micro-commutateur supplémentaire

- Sur demande version 24V ou 110V

Lot minimum 20 pièces

ОПЦИИ:

- ВЕРСИЯ С 1 ДОПОЛНИТЕЛЬНЫМ МИКРОВЫКЛЮЧАТЕЛЕМ ПОД ЗАКАЗ

- ВЕРСИЯ 24V ИЛИ 110V ПОД ЗАКАЗ

МИНИМУМ 20 ШТ.



CARATTERISTICHE TECNICHE ATTUATORI ELETTRICI IVR MH - R / Q & ACCESSORI | TECHNICAL FEATURES IVR MH - R / Q ELECTRIC ACTUATORS & ACCESSORIES

Caratt. Attuatori - mod.	Actuator - mod.	MH-R-E 25			MH-R 25			MH-R 45			MH-R-E 50			MH-Q 67		
Tensione (V) AC 50/60 Hz	Voltage (V) AC 50/60 Hz	115	230		230		115	230	400	115	230		115	230	400	
/sec.	/sec.	7	7		12		5	5	5	33	33		32	32	32	
Tempo manovra /sec.	Operation times /sec.	12	12				12	12								
/sec.	/sec.						30	30								
Coppia max. ON/OFF / Nm	Torque max ON/OFF / Nm	25			25			45			50			65		
Coppia max.in Modolazione / Nm	Max modulation Torque / Nm	12,5			12,5			25			25			33		
Rotazione std.	Std. rotation	90°			90°			90°			90°			90°		
Grado protezione (1)	Enclosure (1)	IP65			IP65			IP65			IP67			IP67		
Comando manuale di emergenza	Emergency manual control	si			si			si			si			si		
Indicatore di posizione	Position indicator	si			si			si			si			si		
Attacco ISO 5211 std.	ISO 5211 std.	F04/F05/F07			F04/F05/F07			F04/F05/F07			F05/F07			F05/F07		
2 Limitatori di coppia	2 Torque limiting device	vedi (2)			vedi (2)			vedi (2)			vedi (2)			vedi (2)		
Fine corsa meccanici n°	Mechanical Microswitches n°	1			1			1			2			2		
Fine corsa elettrici n°	Electric microswitches n°	2			2			2			2			2		
Temperature di utilizzo S2	Working temperature S2	-25° +70° C			-20° +80° C			-20° +80° C			-25° +70° C			-20° +80° C		
Temperature di utilizzo S4 (3)	Working temperature S4 (3)	-25° +70° C			-20° +60° C			-20° +60° C			-25° +70° C			-20° +60° C		
Peso Kg	Weight Kg	2,8			4			4			2,8			7		
ATTUATORI Euro/pz.	ACTUATORS Euro/pz.	Euro/pz.			Euro/pz.			Euro/pz.			Euro/pz.			Euro/pz.		
Codice	Code	127210317			127210312			127220330			127230333			127235332		
Attuatori V 230 con boccia non lavorata	Actuators V 230 with not machined bush	ON REQUEST														
Codice	Code							127220405			127230422			127235432		
Attuatori V 400 con boccia non lavorata	Actuators V 400 with not machined bush	ON REQUEST														
Lavorazione boccia	Bush machining															
ACCESSORI Euro/pz.	ACCESSORIES Euro/pz.	Euro/pz.			Euro/pz.			Euro/pz.			Euro/pz.			Euro/pz.		
2 fine corsa supplementari 2VE	2 additional limit switches 2VE	ON REQUEST														
Limitatori di coppia supplementari 2DE	2 additional torque limiting device 2DE															
Resistenza anticondensa 8W HR	Anticondensate heater 8W HR															
Posizionatore 0-(4)-20 mA PSAP.2A con potenziometro PD210	Positioner 0-(4)-20 mA PSAP.2A with potentiometer PD210															
Trasmittitore di posizione PSPT02 con potenziometro PD210	Position transmitter PSPT02 with potentiometer PD210															
Potenziometro PD210	Potentiometer PD210															
Doppio potenziometro PD210	Double potentiometer PD210															
Protezione IP 67 (EN60529)	Enclosure IP 67 (EN60529)															
Protezione IP 68 (EN60529)	Enclosure IP 68 (EN60529)															
Protezione anticorrosiva tipo k2	Anticorrosive enclosure type k2															
Quadro comando locale incorporato per attuatore monofase PSC	Local control box for single-phase actuators PSC															
Quadro comando locale incorporato per attuatore trifase PSC	Local control box for three-phase actuators PSC															

Nel caso di montaggio contemporaneo del Posizionatore e del Trasmittitore di posizione è necessario utilizzare il doppio potenziometro PD2 210

Su attuatori trifasi quando viene richiesto il posizionatore è necessario montare il teleruttore

(1) a richiesta mod. MH-R IP67 - MH-Q IP68

(2) senza limitatori di coppia, motore sincrono che va in stallo o con protezione termica

(3) S2 funzionamento ON / OFF - S4 funzionamento in modulazione (normativa IEC 60034)

* Boccia D/D solo per valvole a farfalla



CARATTERISTICHE TECNICHE ATTUATORI ELETTRICI IVR MH - R / Q & ACCESSORI TECHNICAL FEATURES IVR MH - R / Q ELECTRIC ACTUATORS & ACCESSORIES																	
MH-Q 77			MH-Q 102			MH-Q 202			MH-Q 502			MH-Q 702			MH-Q 1002		
115	230	400	115	230	400	115	230	400	115	230	400	115	230	400	115	230	400
60	60		16	16	16	20	20		29	29	29	29	29	29	29	29	93
			32	32	32	28	28	28	43	43	43	43	43	43	43	43	93
			57	57	57	69	69	69	93	93	93	93	93	93			93
75			130			250			500			700			1000		
38			65			125			250			350			500		
90°			90°			90°			90°			90°			90°		
IP67			IP67			IP67			IP67			IP67			IP67		
si			si			si			si			si			si		
si			si			si			si			si			si		
F05/F07			F05/F07			F07/F10			F10 o F12			F10 o F12 o F14			F12 o F14		
vedi (2)			2			2			2			2			2		
2			2			2			2			2			2		
2			2			2			2			2			2		
-20° +80° C			-20° +80° C			-20° +80° C			-20° +80° C			-20° +80° C			-20° +80° C		
-20° +60° C			-20° +60° C			-20° +60° C			-20° +60° C			-20° +60° C			-20° +60° C		
7			7			13			27			27			27		
Euro/pz.			Euro/pz.			Euro/pz.			Euro/pz.			Euro/pz.			Euro/pz.		
127240360			127250332			127260369			127275393			127285393			127295393		
ON REQUEST																	
			127250432			127260469			127275493			127285493			127295493		
ON REQUEST																	
Euro/pz.			Euro/pz.			Euro/pz.			Euro/pz.			Euro/pz.			Euro/pz.		
ON REQUEST																	

In case a positioner and a position transmitter are request, a double potentiometer PD2 210 is request
Electromagnetic switch is request in case a positioner is installed on three-phase actuators

(1) on request mod. MH-R IP67 - MH-Q IP68

(2) without torque limiting devices but with synchronous motor to be installed or with thermal protection

(3) S2 function ON / OFF - S4 modulation function (IEC 60034)

* Bush D/D only for butterfly valves



ATTUATORI PNEUMATICI
ACTUATEURS PNEUMATIQUES
ROTIERENDE DREHANTRIEBE
ACTUATEURS PNEUMATIQUES
ПНЕВМАТИЧЕСКИЕ ПРИВОДЫ

In accordo alle Direttive Europee
According to European Directive
94/9/EC-ATEX
ISO 5211:2003
VDI/VDE 3845:2004

IVR 665 + IVR 270



IVR 665 - Valvola a sfera in tre pezzi in acciaio inox - attacchi F/F- flangia ISO 5211 +
IVR 270 - Attuatori Pneumatici rotanti - DOPPIO EFFETTO

IVR 665 - 3-piece ball valve in stainless steel - threaded ends F/F - ISO 5211 flange +
IVR 270 - Pneumatic rotary actuators - DOUBLE ACTING

IVR 665 - Kugelhahn, dreiteilig, aus Edelstahl - IG/IG- Flansch ISO 5211 +
IVR 270 - Rotierende Drehantriebe - DOPPELWIRKEND

IVR 665 - Vanne à boisseau sphérique en trois pièces en acier inox - fixations F/F - bride ISO 5211 +
IVR 270 - Actuateurs Pneumatiques tournants - DOUBLE EFFET

IVR 665 - трёхсоставной шаровой кран из нержавеющей стали - соединения В/В - фланец ISO 5211 +
IVR 270 - Пневматические поворотные приводы - ДВОЙНОГО ДЕЙСТВИЯ

Cod./Code	Misura/Size	□/田	€
466502300	IVR 665 DN 1/4" + MHP-0DA	1	112,85
466503300	IVR 665 DN 3/8" + MHP-0DA	1	112,97
466505302	IVR 665 DN 1/2" + MHP-1DA	1	126,33
466507304	IVR 665 DN 3/4" + MHP-1DA	1	138,01
466510304	IVR 665 DN 1" + MHP-1DA	1	146,78
466512307	IVR 665 DN 1"1/4 + MHP-2DA	1	177,02
466515307	IVR 665 DN 1"1/2 + MHP-2DA	1	197,35
466520307	IVR 665 DN 2" + MHP-2DA	1	225,48
466525315	IVR 665 DN 2"1/2 + MHP-3,5DA	1	429,69
466530315	IVR 665 DN 3" + MHP-3,5DA	1	536,26
466540317	IVR 665 DN 4" + MHP-4DA	1	749,41



IVR 670 + IVR 270



IVR 670 - Valvola a sfera in tre pezzi in acciaio inox - attacchi a saldare- flangia ISO 5211 +
IVR 270 - Attuatori Pneumatici rotanti - DOPPIO EFFETTO

IVR 670 - 3-piece ball valve in stainless steel- butt weld connections - ISO 5211 flange +
IVR 270 - Pneumatic rotary actuators - DOUBLE ACTING

IVR 670 - Kugelhahn, dreiteilig, aus Edelstahl - Schweissenden- Flansch ISO 5211 +
IVR 270 - Rotierende Drehantriebe - DOPPELWIRKEND

IVR 670 - Vanne à boisseau sphérique en trois pièces en acier inox - fixations à souder- bride ISO 5211 +
IVR 270 - Actuateurs Pneumatiques tournants - DOUBLE EFFET

IVR 670 - трёхсоставной шаровой кран из нержавеющей стали - соединения под приварку -
фланец ISO 5211 +

IVR 270 - Пневматические поворотные приводы - ДВОЙНОГО ДЕЙСТВИЯ

Cod./Code	Misura/Size	□/田	€
467002300	IVR 670 DN 1/4" + MHP-0DA	1	112,21
467003300	IVR 670 DN 3/8" + MHP-0DA	1	112,21
467005302	IVR 670 DN 1/2" + MHP-1DA	1	125,37
467007304	IVR 670 DN 3/4" + MHP-1DA	1	136,69
467010304	IVR 670 DN 1" + MHP-1DA	1	145,46
467012307	IVR 670 DN 1"1/4 + MHP-2DA	1	175,45
467015307	IVR 670 DN 1"1/2 + MHP-2DA	1	194,83
467020307	IVR 670 DN 2" + MHP-2DA	1	227,49
467025315	IVR 670 DN 2"1/2 + MHP-3,5DA	1	433,03
467030315	IVR 670 DN 3" + MHP-3,5DA	1	539,44
467040317	IVR 670 DN 4" + MHP-4DA	1	752,29



IVR 672 + IVR 270



IVR 672 - Valvola a sfera a passaggio totale in tre pezzi in acciaio inox AISI 316 - Attacchi a saldare di tasca - Flangia ISO 5211 + IVR 270 - Attuatori Pneumatici rotanti - DOPPIO EFFETTO

IVR 672 - Three-piece full bore ball valve in stainless steel AISI 316 - Socked weld connection - ISO 5211 flange + IVR 270 - Pneumatic rotary actuators - DOUBLE ACTING

IVR 672 - Kugelhahn dreiteilig mit vollem Durchgang aus Edelstahl AISI 316 - Schweißanschlüsse - Flansch ISO 5211 + IVR 270 - Rotierende Drehantriebe - DOPPELWIRKEND

IVR 672 - Vanne à boisseau sphérique à passage intégral en trois pièces en acier inox AISI 316 - Fixations à souder de poche - Bride ISO 5211 + IVR 270 - Actuateurs Pneumatiques tournants - DOUBLE EFFET

IVR 672 - Трёхсоставной полнопроходной шаровой кран из нержавеющей стали AISI 316 - Соединения под приварку (карман) - фланец ISO 5211 + IVR 270 - Пневматические поворотные приводы - ДВОЙНОГО ДЕЙСТВИЯ

Cod./Code	Misura/Size	□/☒	€
467202300	IVR 672 DN 1/4" + MHP-0DA	1	113,45
467203300	IVR 672 DN 3/8" + MHP-0DA	1	113,45
467205302	IVR 672 DN 1/2" + MHP-1DA	1	126,61
467207304	IVR 672 DN 3/4" + MHP-1DA	1	138,56
467210304	IVR 672 DN 1" + MHP-1DA	1	147,64
467212307	IVR 672 DN 1"1/4 + MHP-2DA	1	178,90
467215307	IVR 672 DN 1"1/2 + MHP-2DA	1	199,18
467220307	IVR 672 DN 2" + MHP-2DA	1	232,72
467225315	IVR 672 DN 2"1/2 + MHP-3,5DA	1	445,46
467230315	IVR 672 DN 3" + MHP-3,5DA	1	557,29
467240317	IVR 672 DN 4" + MHP-4DA	1	780,01



IVR 144 L + IVR 270



IVR 144L - Valvola a sfera a passaggio ridotto a tre vie in acciaio inox AISI 316 - sfera forata a L - attacchi F/F/F - flangia ISO 521 + IVR 270 - Attuatori Pneumatici rotanti - DOPPIO EFFETTO

IVR 144L - 3-way reduce bore ball valve in stainless steel AISI 316 - bored ball as L - threaded ends F/F/F - ISO 5211 flange + IVR 270 - Pneumatic rotary actuators - DOUBLE ACTING

IVR 144L - 3-Wege-Kugelhahn mit reduziertem Durchgang aus Edelstahl AISI 316 - Kugel mit L-Bohrung- IG/IG/IG - Flansch ISO 521 + IVR 270 - Rotierende Drehantriebe - DOPPELWIRKEND

IVR 144L - Vanne à boisseau sphérique à passage réduit à trois voies en acier inox AISI 316 - sphère percée en L - fixations F/F/F - bride ISO 5211 + IVR 270 - Actuateurs Pneumatiques tournants - DOUBLE EFFET

IVR 144L - трёхходовый шаровой кран из нержавеющей стали AISI 316 с редуцированным проходом - проход шара L - соединения В/В/В - фланец ISO 5211 + IVR 270 - Пневматические поворотные приводы - ДВОЙНОГО ДЕЙСТВИЯ

Cod./Code	Misura/Size	□/☒	€
414402300	IVR 144L DN 1/4" + MHP-0DA	1	138,16
414403300	IVR 144L DN 3/8" + MHP-0DA	1	138,16
414405300	IVR 144L DN 1/2" + MHP-0DA	1	138,16
414407304	IVR 144L DN 3/4" + MHP-1DA	1	164,20
414410304	IVR 144L DN 1" + MHP-1DA	1	186,38
414412307	IVR 144L DN 1"1/4 + MHP-2DA	1	257,65
414415310	IVR 144L DN 1"1/2 + MHP-3DA	1	329,99
414420315	IVR 144L DN 2" + MHP-3,5DA	1	493,88



IVR 145 T + IVR 270



IVR 145T - Valvola a sfera a passaggio ridotto a tre vie in acciaio inox AISI 316 - sfera forata a T - attacchi F/F/F - flangia ISO 5211 6 + IVR 270 - Attuatori Pneumatici rotanti - DOPPIO EFFETTO

IVR 145T - 3-way reduced bore ball valve in stainless steel AISI 316 - bored ball as T - threaded ends F/F/F - ISO 5211 flange + IVR 270 - Pneumatic rotary actuators - DOUBLE ACTING

IVR 145T - 3-Wege-Kugelhahn mit reduziertem Durchgang aus Edelstahl AISI 316 - Kugel mit T-Bohrung- IG/IG/IG - Flansch ISO 5211 6 + IVR 270 - Rotierende Drehantriebe - DOPPELWIRKEND

IVR 145T - Vanne à boisseau sphérique à passage réduit à trois voies en acier inox AISI 316 - sphère percée en T - fixations F/F/F - bride ISO 5211 + IVR 270 - Actuateurs Pneumatiques tournants - DOUBLE EFFET

IVR 145T - трёхходовый шаровой кран из нержавеющей стали AISI 316 с редуцированным проходом - проход шара "Т" - соединения В/В/В - фланец ISO 5211 + IVR 270 - Пневматические поворотные приводы - ДВОЙНОГО ДЕЙСТВИЯ

Cod./Code	Misura/Size	□/☒	€
414502300	IVR 145T DN 1/4" + MHP-0DA	1	138,16
414503300	IVR 145T DN 3/8" + MHP-0DA	1	138,16
414505300	IVR 145T DN 1/2" + MHP-0DA	1	138,16
414507304	IVR 145T DN 3/4" + MHP-1DA	1	164,20
414510304	IVR 145T DN 1" + MHP-1DA	1	186,08
414512307	IVR 145T DN 1"1/4 + MHP-2DA	1	256,72
414515310	IVR 145T DN 1"1/2 + MHP-3DA	1	328,76
414520315	IVR 145T DN 2" + MHP-3,5DA	1	490,13



IVR 685 + IVR 270



IVR 685 - Valvola a sfera a corpo piatto flangiata in acciaio inox - flangia ISO 5211 - attacchi flangiati PN16 + IVR 270 - Attuatori Pneumatici rotanti - DOPPIO EFFETTO

IVR 685 - WAFER flanged ball valve PN16 - stainless steel - ISO 5211 flange + IVR 270 - Pneumatic rotary actuators - DOUBLE ACTING

IVR 685 - Kugelhahn mit flachem, angeflanschem Körper aus Edelstahl - Flansch ISO 5211 - Flanschanschlüsse PN16 + IVR 270 - Rotierende Drehantriebe - DOPPELWIRKEND

IVR 685 - Vanne à boisseau sphérique à corps plat bridée en acier inox - bride ISO 5211 - fixations bridées PN16 + IVR 270 - Actuateurs Pneumatiques tournants - DOUBLE EFFET

IVR 685 - Шаровой кран с укороченным корпусом из нержавеющей стали - фланец ISO 5211 - фланцевое соединение PN16 + IVR 270 - Пневматические поворотные приводы - ДВОЙНОГО ДЕЙСТВИЯ

Cod./Code	Misura/Size	□/田	€
468505300	IVR 685 DN 15 + MHP-0DA	1	145,94
468507302	IVR 685 DN 20 + MHP-1DA	1	198,96
468510304	IVR 685 DN 25 + MHP-1DA	1	183,87
468512304	IVR 685 DN 32 + MHP-1DA	1	202,26
468515307	IVR 685 DN 40 + MHP-2DA	1	247,58
468520310	IVR 685 DN 50 + MHP-3DA	1	334,81
468525317	IVR 685 DN 65 + MHP-4DA	1	514,15
468530320	IVR 685 DN 80 + MHP-4,5DA	1	696,52
468540322	IVR 685 DN 100 + MHP-5DA	1	983,26



IVR 77 + IVR 270



IVR 77 - Valvola flangiata in ghisa GJL 250 - attacchi flangiati PN16 + IVR 270 - Attuatori Pneumatici rotanti - DOPPIO EFFETTO

IVR 77 - Cast iron GJL 250 ball valve - flanged ends PN16 + IVR 270 - Pneumatic rotary actuators - DOUBLE ACTING

IVR 77 - Flansch-Kugelhahn aus Gusseisen GJL 250 - Flanschanschlüsse PN16 + IVR 270 - Rotierende Drehantriebe - DOPPELWIRKEND

IVR 77 - Vanne bride en fonte GJL 250 - fixations bridées PN16 + IVR 270 - Actuateurs Pneumatiques tournants - DOUBLE EFFET

IVR 77 - Шаровой кран из чугуна GJL 250 - Фланцевое соединение PN16 + IVR 270 - Пневматические поворотные приводы - ДВОЙНОГО ДЕЙСТВИЯ

Cod./Code	Misura/Size	□/田	€
407707306	IVR 77 DN 20 + MHP-2DA	1	195,04
407710306	IVR 77 DN 25 + MHP-2DA	1	210,85
407712306	IVR 77 DN 32 + MHP-2DA	1	217,76
407715310	IVR 77 DN 40 + MHP-3DA	1	260,14
407720310	IVR 77 DN 50 + MHP-3DA	1	270,70
407725311	IVR 77 DN 65 + MHP-3DA	1	346,77
407730315	IVR 77 DN 80 + MHP-3,5DA	1	431,84
407740317	IVR 77 DN 100 + MHP-4DA	1	505,51
407750320	IVR 77 DN 125 + MHP-4,5DA	1	856,15
407760320	IVR 77 DN 150 + MHP-4,5DA	1	1045,37



IVR 78 + IVR 270



IVR 78 - Valvola flangiata in ghisa GJL 250 - asta e sfera inox - attacchi flangiati PN16 + IVR 270 - Attuatori Pneumatici rotanti - DOPPIO EFFETTO

IVR 78 - Cast iron GJL 250 ball valve - inox stem and ball - flanged ends PN16 + IVR 270 - Pneumatic rotary actuators - DOUBLE ACTING

IVR 78 - Flansch-Kugelhahn aus Gusseisen GJL 250 - Stab und Kugel aus Edelstahl - Flanschanschlüsse PN16 + IVR 270 - Rotierende Drehantriebe - DOPPELWIRKEND

IVR 78 - Vanne bride en fonte GJL 250 - tige et sphère inox - fixations bridées PN16 + IVR 270 - Actuateurs pneumatiques tournants - DOUBLE EFFET

IVR 78 - Шаровой кран из чугуна GJL 250 - шток и шар из нержавеющей стали - Фланцевое соединение PN16 + IVR 270 - Пневматические поворотные приводы - ДВОЙНОГО ДЕЙСТВИЯ

Cod./Code	Misura/Size	□/田	€
407807306	IVR 78 DN 20 + MHP-2DA	1	192,03
407810306	IVR 78 DN 25 + MHP-2DA	1	211,47
407812306	IVR 78 DN 32 + MHP-2DA	1	235,57
407815310	IVR 78 DN 40 + MHP-3DA	1	295,43
407820310	IVR 78 DN 50 + MHP-3DA	1	312,88
407825311	IVR 78 DN 65 + MHP-3DA	1	379,93
407830315	IVR 78 DN 80 + MHP-3,5DA	1	486,20
407840317	IVR 78 DN 100 + MHP-4DA	1	595,34
407850320	IVR 78 DN 125 + MHP-4,5DA	1	995,94
407860320	IVR 78 DN 150 + MHP-4,5DA	1	1302,45



IVR 276 CF8M + IVR 270



IVR 276 CF8M - Valvola a farfalla in ghisa tipo WAFER - disco inox - attacchi flangiati PN16 + IVR 270 - Attuatori Pneumatici rotanti - DOPPIO EFFETTO

IVR 276 CF8M - Butterfly valve WAFER type - stainless steel disc - flanged ends PN16 + IVR 270 - Pneumatic rotary actuators - DOUBLE ACTING

IVR 276 CF8M - Ventil mit Flügelgriff aus Gusseisen - Typ WAFER - Edstahlscheibe - Flanschanschlüsse PN16 + IVR 270 - Rotierende Drehantriebe - DOPPELWIRKEND

IVR 276 CF8M - Vanne papillon en fonte type WAFER - disque inox - fixations bridées PN16 + IVR 270 - Actuateurs Pneumatiques tournants - DOUBLE EFFET

IVR 276 CF8M - Дисковый затвор «Баттерфляй» из чугуна - тип WAFER - диск из нержавеющей стали - Фланцевое соединение PN 16 + IVR 270 - Пневматические поворотные приводы - ДВОЙНОГО ДЕЙСТВИЯ

Cod./Code	Misura/Size	□/田	€
427615304	IVR 276 CF8M DN 40 + MHP-1DA	1	186,85
427620304	IVR 276 CF8M DN 50 + MHP-1DA	1	189,76
427625307	IVR 276 CF8M DN 65 + MHP-2DA	1	222,06
427630310	IVR 276 CF8M DN 80 + MHP-3DA	1	282,38
427640311	IVR 276 CF8M DN 100 + MHP-3DA	1	310,60
427650315	IVR 276 CF8M DN 125 + MHP-3,5DA	1	414,73
427660317	IVR 276 CF8M DN 150 + MHP-4DA	1	493,46
427680322	IVR 276 CF8M DN 200 + MHP-5DA	1	759,28
427690326	IVR 276 CF8M DN 250 + MHP-6DA	1	1350,32
427695329	IVR 276 CF8M DN 300 + MHP-8DA	1	2252,53



IVR 175 + IVR 270



IVR 175 - Valvola a farfalla in ghisa tipo LUG - attacchi flangiati PN16 + IVR 270 - Attuatori Pneumatici rotanti - DOPPIO EFFETTO

IVR 175 - Butterfly valve LUG type - flanged ends PN16 + IVR 270 - Pneumatic rotary actuators - DOUBLE ACTING

IVR 175 - Ventil mit Flügelgriff aus Gusseisen Typ LUG - Flanschanschlüsse PN16 + IVR 270 - Rotierende Drehantriebe - DOPPELWIRKEND

IVR 175 - Vanne papillon en fonte type LUG - fixations bridées PN16 + IVR 270 - Actuateurs Pneumatiques tournants - DOUBLE EFFET

IVR 175 - Дисковый затвор «Баттерфляй» из чугуна - тип LUG - Фланцевое соединение PN16 + IVR 270 - Пневматические поворотные приводы - ДВОЙНОГО ДЕЙСТВИЯ

Cod./Code	Misura/Size	□/田	€
417515304	IVR 175 DN 40 + MHP-1DA	1	177,29
417520304	IVR 175 DN 50 + MHP-1DA	1	179,62
417525307	IVR 175 DN 65 + MHP-2DA	1	205,89
417530310	IVR 175 DN 80 + MHP-3DA	1	262,84
417540311	IVR 175 DN 100 + MHP-3DA	1	282,34
417550315	IVR 175 DN 125 + MHP-3,5DA	1	367,13
417560317	IVR 175 DN 150 + MHP-4DA	1	423,64



IVR 176 + IVR 270



IVR 176 - Valvola a farfalla in ghisa tipo WAFER - attacchi flangiati PN16 + IVR 270 - Attuatori Pneumatici rotanti - DOPPIO EFFETTO

IVR 176 - Butterfly valve WAFER type - flanged ends PN16 + IVR 270 - Pneumatic rotary actuators - DOUBLE ACTING

IVR 176 - Ventil mit Flügelgriff aus Gusseisen Typ WAFER - Flanschanschlüsse PN16 + IVR 270 - Rotierende Drehantriebe - DOPPELWIRKEND

IVR 176 - Vanne papillon en fonte type WAFER - fixations bridées PN16 + IVR 270 - Actuateurs pneumatiques tournants - DOUBLE EFFET

IVR 176 - Дисковый затвор «Баттерфляй» из чугуна - тип WAFER - Фланцевое соединение PN16 + IVR 270 - Пневматические поворотные приводы - ДВОЙНОГО ДЕЙСТВИЯ

Cod./Code	Misura/Size	□/田	€
417615304	IVR 176 DN 40 + MHP-1DA	1	171,59
417620304	IVR 176 DN 50 + MHP-1DA	1	173,62
417625307	IVR 176 DN 65 + MHP-2DA	1	201,88
417630310	IVR 176 DN 80 + MHP-3DA	1	256,42
417640311	IVR 176 DN 100 + MHP-3DA	1	264,71
417650315	IVR 176 DN 125 + MHP-3,5DA	1	347,78
417660317	IVR 176 DN 150 + MHP-4DA	1	398,71
417680322	IVR 176 DN 200 + MHP-5DA	1	598,99
417690326	IVR 176 DN 250 + MHP-6DA	1	1026,58
417695329	IVR 176 DN 300 + MHP-8DA	1	1740,40



IVR 665 + IVR 271



IVR 665 - Valvola a sfera in tre pezzi in acciaio inox - attacchi F/F - flangia ISO 5211 +
IVR 271 - Attuatori Pneumatici rotanti - SEMPLICE EFFETTO
IVR 665 - Three-piece ball valve in stainless steel - threaded ends F/F - ISO 5211 flange +
IVR 271 - Pneumatic rotary actuators - SPRING RETURN
IVR 665 - Kugelhahn, dreiteilig, aus Edelstahl - IG/IG - Flansch ISO 5211 +
IVR 271 - Rotierende Drehantriebe - EINFACHWIRKEND
IVR 665 - Vanne à boisseau sphérique en trois pièces en acier inox - fixations F/F - bride ISO 5211 +
IVR 271 - Actuateurs pneumatiques tournants - EFFET SIMPLE
IVR 665 - трёхсоставной шаровой кран из нержавеющей стали - соединения В/В - фланец ISO 5211 +
IVR 271 - Пневматические поворотные приводы - ПРОСТОГО ДЕЙСТВИЯ



Cod./Code	Misura/Size	□/田	€
466502352	IVR 665 DN 1/4" + MHP-1SR	1	151,56
466503352	IVR 665 DN 3/8" + MHP-1SR	1	151,56
466505355	IVR 665 DN 1/2" + MHP-2SR	1	153,86
466507356	IVR 665 DN 3/4" + MHP-2SR	1	180,09
466510360	IVR 665 DN 1" + MHP-3SR	1	244,33
466512360	IVR 665 DN 1*1/4 + MHP-3SR	1	258,35
466515365	IVR 665 DN 1*1/2 + MHP-3,5SR	1	340,85
466520365	IVR 665 DN 2" + MHP-3,5SR	1	368,98
466525370	IVR 665 DN 2*1/2 + MHP-4,5SR	1	627,44
466530370	IVR 665 DN 3" + MHP-4,5SR	1	734,02
466540372	IVR 665 DN 4" + MHP-5SR	1	975,57

IVR 670 + IVR 271



IVR 670 - Valvola a sfera in tre pezzi in acciaio inox - attacchi a saldare - flangia ISO 5211 +
IVR 271 - Attuatori Pneumatici rotanti - SEMPLICE EFFETTO
IVR 670 - Three-piece ball valve in stainless steel- butt weld connections - ISO 5211 flange +
IVR 271 - Pneumatic rotary actuators - SPRING RETURN
IVR 670 - Kugelhahn, dreiteilig, aus Edelstahl - Schweissenden - Flansch ISO 5211 +
IVR 271 - Rotierende Drehantriebe - EINFACHWIRKEND
IVR 670 - Vanne à boisseau sphérique en trois pièces en acier inox - fixations à souder- bride ISO 5211 +
IVR 271 - Actuateurs pneumatiques tournants - EFFET SIMPLE
IVR 670 - трёхсоставной шаровой кран - из нержавеющей стали - соединения под приварку -
фланец ISO 5211 +
IVR 271-Пневматические поворотные приводы - ПРОСТОГО ДЕЙСТВИЯ



Cod./Code	Misura/Size	□/田	€
467002352	IVR 670 DN 1/4" + MHP-1SR	1	150,93
467003352	IVR 670 DN 3/8" + MHP-1SR	1	150,93
467005355	IVR 670 DN 1/2" + MHP-2SR	1	152,48
467007356	IVR 670 DN 3/4" + MHP-2SR	1	177,63
467010360	IVR 670 DN 1" + MHP-3SR	1	242,60
467012360	IVR 670 DN 1*1/4 + MHP-3SR	1	256,77
467015365	IVR 670 DN 1*1/2 + MHP-3,5SR	1	338,98
467020365	IVR 670 DN 2" + MHP-3,5SR	1	373,65
467025370	IVR 670 DN 2*1/2 + MHP-4,5SR	1	634,66
467030370	IVR 670 DN 3" + MHP-4,5SR	1	741,07
467040372	IVR 670 DN 4" + MHP-5SR	1	982,88



IVR 672 + IVR 271



IVR 672 - Valvola a sfera in tre pezzi in acciaio inox - attacchi a saldare di tasca - flangia ISO 5211 + IVR 271 - Attuatori Pneumatici rotanti - SEMPLICE EFFETTO

IVR 672 - Three-piece ball valve in stainless steel- socket weld connections - ISO 5211 flange + IVR 271 - Pneumatic rotary actuators - SPRING RETURN

IVR 672 - Kugelhahn, dreiteilig, aus Edelstahl - Schweißanschlüsse - Flansch ISO 5211 + IVR 271 - Rotierende Drehantriebe - EINFACHWIRKEND

IVR 672 - Vanne à boisseau sphérique en trois pièces en acier inox - fixations à souder de poche - bride ISO 5211 + IVR 271 - Actuateurs Pneumatiques tournants - EFFET SIMPLE

IVR 672 - трёхсоставной шаровой кран из нержавеющей стали - соединения под приварку - фланец ISO 5211 + IVR 271 - Пневматические приводы поворотные - ПРОСТОГО ДЕЙСТВИЯ

Cod./Code	Misura/Size	□/田	€
467202352	IVR 672 DN 1/4" + MHP-1SR	1	152,16
467203352	IVR 672 DN 3/8" + MHP-1SR	1	152,16
467205355	IVR 672 DN 1/2" + MHP-2SR	1	153,72
467207356	IVR 672 DN 3/4" + MHP-2SR	1	179,50
467210360	IVR 672 DN 1" + MHP-3SR	1	244,77
467212360	IVR 672 DN 1"1/4" + MHP-3SR	1	260,22
467215365	IVR 672 DN 1"1/2" + MHP-3,5SR	1	343,33
467220365	IVR 672 DN 2" + MHP-3,5SR	1	379,69
467225370	IVR 672 DN 2"1/2" + MHP-4,5SR	1	647,09
467230370	IVR 672 DN 3" + MHP-4,5SR	1	758,92
467240372	IVR 672 DN 4" + MHP-5SR	1	1010,60



IVR 144 L + IVR 271



IVR 144L - Valvola a sfera a passaggio ridotto a tre vie in acciaio inox AISI 316 - sfera forata a L - attacchi F/F/F - flangia ISO 5211 + IVR 271 - Attuatori Pneumatici rotanti - SEMPLICE EFFETTO

IVR 144L - 3-way reduce bore ball valve in stainless steel AISI 316 - bored ball as L - threaded ends F/F/F - ISO 5211 flange + IVR 271 - Pneumatic rotary actuators - SPRING RETURN

IVR 144L - 3-Wege-Kugelhahn mit reduziertem Durchgang aus Edelstahl AISI 316 - Kugel mit L-Bohrung - IG/IG/IG - Flansch ISO 5211 + IVR 271 - Rotierende Drehantriebe - EINFACHWIRKEND

IVR 144L - Vanne à boisseau sphérique à passage réduit à trois voies en acier inox AISI 316 - sphère percée en L - fixations F/F/F - bride ISO 521 + IVR 271 - Actuateurs pneumatiques tournants - EFFET SIMPLE

IVR 144L - трёхходовой шаровой кран из нержавеющей стали AISI 316 с редуцированным проходом - проход шара "L" - соединения В/В/В - фланец ISO 5211 + IVR 271 - Пневматические поворотные приводы - ПРОСТОГО ДЕЙСТВИЯ

Cod./Code	Misura/Size	□/田	€
414402352	IVR 144L DN 1/4" + MHP-1SR	1	176,88
414403352	IVR 144L DN 3/8" + MHP-1SR	1	176,88
414405352	IVR 144L DN 1/2" + MHP-1SR	1	176,88
414407356	IVR 144L DN 3/4" + MHP-2SR	1	204,81
414410356	IVR 144L DN 1" + MHP-2SR	1	227,31
414412360	IVR 144L DN 1"1/4" + MHP-3SR	1	339,33
414415364	IVR 144L DN 1"1/2" + MHP-3,5SR	1	433,51
414420367	IVR 144L DN 2" + MHP-4SR	1	589,34



IVR 145 T + IVR 271



IVR 145T - Valvola a sfera a passaggio ridotto a tre vie in acciaio inox AISI 316 - sfera forata a T - attacchi F/F/F - flangia ISO 5211 + IVR 271 - Attuatori Pneumatici rotanti - SEMPLICE EFFETTO

IVR 145T - 3-way reduced bore ball valve in stainless steel AISI 316 - bored ball as T - threaded ends F/F/F - ISO 5211 flange + IVR 271 - Pneumatic rotary actuators - SPRING RETURN

IVR 145T - 3-Wege-Kugelhahn mit reduziertem Durchgang aus Edelstahl AISI 316 - Kugel mit T-Bohrung - IG/IG/IG - Flansch ISO 5211 + IVR 271 - Rotierende Drehantriebe - EINFACHWIRKEND

IVR 145T - Vanne à boisseau sphérique à passage réduit à trois voies en acier inox AISI 316 - sphère percée en T - fixations F/F/F - bride ISO 5211 + IVR 271 - Actuateurs pneumatiques tournants - EFFET SIMPLE

IVR 145T - трёхходовой шаровой кран из нержавеющей стали AISI 316 с редуцированным проходом - проход шара "Т" - соединения В/В/В - фланец ISO 5211 + IVR 271 - Пневматические поворотные приводы - ПРОСТОГО ДЕЙСТВИЯ

Cod./Code	Misura/Size	□/田	€
414502352	IVR 145T DN 1/4" + MHP-1SR	1	176,88
414503352	IVR 145T DN 3/8" + MHP-1SR	1	176,88
414505352	IVR 145T DN 1/2" + MHP-1SR	1	176,88
414507356	IVR 145T DN 3/4" + MHP-2SR	1	204,81
414510356	IVR 145T DN 1" + MHP-2SR	1	227,01
414512360	IVR 145T DN 1 1/4" + MHP-3SR	1	338,39
414515364	IVR 145T DN 1 1/2" + MHP-3,5SR	1	432,27
414520367	IVR 145T DN 2" + MHP-4SR	1	585,59

IVR 685 + IVR 271



IVR 685 - Valvola a sfera a corpo piatto flangiata in acciaio inox - flangia ISO 5211 - attacchi flangiati PN16 + IVR 271 - Attuatori Pneumatici rotanti - SEMPLICE EFFETTO

IVR 685 - WAFER flanged ball valve PN16 - stainless steel - ISO 5211 flange + IVR 271 - Pneumatic rotary actuators - SPRING RETURN

IVR 685 - Kugelhahn mit flachem, angeflanschem Körper aus Edelstahl - Flansch ISO 5211 - Flanschanschlüsse PN16 + IVR 271 - Rotierende Drehantriebe - EINFACHWIRKEND

IVR 685 - Vanne à boisseau sphérique à corps plat bridée en acier inox - bride ISO 5211 - fixations bridées PN16 + IVR 271 - Actuateurs pneumatiques tournants - EFFET SIMPLE

IVR 685 - Шаровой кран с укороченным корпусом из нержавеющей стали - фланцевое соединение PN16 + IVR 271 - Пневматические поворотные приводы - ПРОСТОГО ДЕЙСТВИЯ

Cod./Code	Misura/Size	□/田	€
468505352	IVR 685 DN 15 + MHP-1SR	1	184,34
468507355	IVR 685 DN 20 + MHP-2SR	1	249,50
468510360	IVR 685 DN 25 + MHP-3SR	1	280,53
468512360	IVR 685 DN 32 + MHP-3SR	1	299,28
468515365	IVR 685 DN 40 + MHP-3,5SR	1	390,80
468520365	IVR 685 DN 50 + MHP-3,5SR	1	436,40
468525372	IVR 685 DN 65 + MHP-5SR	1	731,48
468530374	IVR 685 DN 80 + MHP-5,5SR	1	987,33
468540376	IVR 685 DN 100 + MHP-6SR	1	1507,37

IVR 77 + IVR 271



IVR 77 - Valvola flangiata in ghisa GJL 250 - attacchi flangiati PN16 +
IVR 271 - Attuatori Pneumatici rotanti - SEMPLICE EFFETTO

IVR 77 - Cast iron GJL 250 ball valve - flanged ends PN16 +
IVR 271 - Pneumatic rotary actuators - SPRING RETURN

IVR 77 - Flansch-Kugelhahn aus Gusseisen GJL 250 - Flanschanschlüsse PN16 +
IVR 271 - Rotierende Drehantriebe - EINFACHWIRKEND

IVR 77 - Vanne bride en fonte GJL 250 - fixations bridées PN16 +
IVR 271 - Actuateurs pneumatiques tournants - EFFET SIMPLE

IVR 77 - Шаровой кран из чугуна GJL 250 - Фланцевое соединение PN16 +
IVR 271 - Пневматические поворотные приводы - ПРОСТОГО ДЕЙСТВИЯ

Cod./Code	Misura/Size	□/田	€
407707359	IVR 77 DN 20 + MHP-3SR	1	311,15
407710359	IVR 77 DN 25 + MHP-3SR	1	326,96
407712363	IVR 77 DN 32 + MHP-3,5SR	1	405,66
407715364	IVR 77 DN 40 + MHP-3,5SR	1	362,90
407720366	IVR 77 DN 50 + MHP-4SR	1	464,71
407725369	IVR 77 DN 65 + MHP-4,5SR	1	589,47
407730369	IVR 77 DN 80 + MHP-4,5SR	1	629,59
407740371	IVR 77 DN 100 + MHP-5SR	1	731,67
407750374	IVR 77 DN 125 + MHP-5,5SR	1	1134,53
407760376	IVR 77 DN 150 + MHP-6SR	1	1598,77



IVR 78 + IVR 271



IVR 78 - Valvola flangiata in ghisa GJL 250 - asta e sfera inox - attacchi flangiati PN16 +
IVR 271 - Attuatori Pneumatici rotanti - SEMPLICE EFFETTO

IVR 78 - Cast iron GJL 250 ball valve - inox stem and ball - flanged ends PN16 +
IVR 271 - Pneumatic rotary actuators - SPRING RETURN

IVR 78 - Flansch-Kugelhahn aus Gusseisen GJL 250 - Stab und Kugel aus Edelstahl - Flanschanschlüsse PN16 +
IVR 271 - Rotierende Drehantriebe - EINFACHWIRKEND

IVR 78 - Vanne bride en fonte GJL 250 - tige et sphère inox - fixations bridées PN16 +
IVR 271 - Actuateurs pneumatiques tournants - EFFET SIMPLE

IVR 78 - Шаровой кран из чугуна GJL 250 - шток и шар из нержавеющей стали - Фланцевое соединение PN16 +
IVR 271 - Пневматические поворотные приводы - ПРОСТОГО ДЕЙСТВИЯ

Cod./Code	Misura/Size	□/田	€
407807359	IVR 78 DN 20 + MHP-3SR	1	308,15
407810359	IVR 78 DN 25 + MHP-3SR	1	327,59
407812363	IVR 78 DN 32 + MHP-3,5SR	1	423,47
407815364	IVR 78 DN 40 + MHP-3,5SR	1	398,20
407820366	IVR 78 DN 50 + MHP-4SR	1	506,89
407825369	IVR 78 DN 65 + MHP-4,5SR	1	622,63
407830369	IVR 78 DN 80 + MHP-4,5SR	1	683,95
407840371	IVR 78 DN 100 + MHP-5SR	1	821,50
407850374	IVR 78 DN 125 + MHP-5,5SR	1	1274,32
407860376	IVR 78 DN 150 + MHP-6SR	1	1855,85



IVR 276 CF8M + IVR 271



IVR 276 CF8M -Valvola a farfalla in ghisa tipo WAFER - disco inox - attacchi flangiati PN16 +
IVR 271 - Attuatori Pneumatici rotanti - SEMPLICE EFFETTO

IVR 276 CF8M - Butterfly valve WAFER type - stainless steel disc - flanged ends PN16 +
IVR 271 - Pneumatic rotary actuators - SPRING RETURN

IVR 276 CF8M -Ventil mit Flügelgriff aus Gusseisen Typ WAFER - Edstahlscheibe - Flanschanschlüsse PN16 +
IVR 271 - Rotierende Drehantriebe - EINFACHWIRKEND

IVR 276 CF8M - Vanne papillon en fonte type WAFER - disque inox - fixations bridées PN16 +
IVR 271 - Actuateurs pneumatiques tournants - EFFET SIMPLE

IVR 276 CF8M - Дисковый затвор «Баттерфляй» из чугуна - тип WAFER - диск из нержавеющей стали -
Фланцевое соединение PN 16 + IVR 271 - Пневматические поворотные приводы - ПРОСТОГО ДЕЙСТВИЯ

Cod./Code	Misura/Size	□/田	€
427615360	IVR 276 CF8M DN 40 + MHP-3SR	1	300,08
427620360	IVR 276 CF8M DN 50 + MHP-3SR	1	302,99
427625360	IVR 276 CF8M DN 65 + MHP-3SR	1	314,31
427630364	IVR 276 CF8M DN 80 + MHP-3,5SR	1	388,20
427640367	IVR 276 CF8M DN 100 + MHP-4SR	1	468,47
427650369	IVR 276 CF8M DN 125 + MHP-4,5SR	1	620,89
427660371	IVR 276 CF8M DN 150 + MHP-5SR	1	728,58
427680376	IVR 276 CF8M DN 200 + MHP-6SR	1	1315,79
427690378	IVR 276 CF8M DN 250 + MHP-8SR	1	2301,80
427695381	IVR 276 CF8M DN 300 + MHP-10SR	1	4576,07



IVR 175 + IVR 271



IVR 175 - Valvola a farfalla in ghisa tipo LUG - attacchi flangiati PN16 +
IVR 271 - Attuatori Pneumatici rotanti - SEMPLICE EFFETTO

IVR 175 - Butterfly valve LUG type - flanged ends PN16 +
IVR 271 - Pneumatic rotary actuators - SPRING RETURN

IVR 175 - Ventil mit Flügelgriff aus Gusseisen Typ LUG - Flanschanschlüsse PN16 IVR 271 - Actuateurs IVR +
IVR 271 - Rotierende Drehantriebe - EINFACHWIRKEND

IVR 175 - Vanne papillon en fonte type LUG - fixations bridées PN16 +
IVR 271 - Actuateurs pneumatiques tournants - EFFET SIMPLE

IVR 175 - Дисковый затвор «Баттерфляй» из чугуна - тип LUG - Фланцевое соединение PN16 +
IVR 271 - Пневматические поворотные приводы - ПРОСТОГО ДЕЙСТВИЯ

Cod./Code	Misura/Size	□/田	€
417515360	IVR 175 DN 40 + MHP-3SR	1	290,52
417520360	IVR 175 DN 50 + MHP-3SR	1	292,86
417525360	IVR 175 DN 65 + MHP-3SR	1	298,13
417530364	IVR 175 DN 80 + MHP-3,5SR	1	368,66
417540367	IVR 175 DN 100 + MHP-4SR	1	440,21
417550369	IVR 175 DN 125 + MHP-4,5SR	1	573,29
417560371	IVR 175 DN 150 + MHP-5SR	1	650,20



IVR 176 + IVR 271



IVR 176 -Valvola a farfalla in ghisa tipo WAFER - attacchi flangiati PN16 +
IVR 271 - Attuatori Pneumatici rotanti - SEMPLICE EFFETTO

IVR 176 - Butterfly valve WAFER type - flanged ends PN16 +
IVR 271 - Pneumatic rotary actuators - SPRING RETURN

IVR 176 -Ventil mit Flügelgriff aus Gusseisen Typ WAFER - Flanschanschlüsse PN16 +
IVR 271 - Rotierende Drehantriebe - EINFACHWIRKEND

IVR 176 - Vanne papillon en fonte type WAFER - fixations bridées PN16 +
IVR 271 - Actuateurs pneumatiques tournants - EFFET SIMPLE

IVR 176 - Дисковый затвор «Баттерфляй» из чугуна - тип WAFER - Фланцевое соединение PN16 +
IVR 271 - Пневматические поворотные приводы - ПРОСТОГО ДЕЙСТВИЯ

Cod./Code	Misura/Size	□/田	€
417615360	IVR 176 DN 40 + MHP-3SR	1	284,83
417620360	IVR 176 DN 50 + MHP-3SR	1	286,85
417625360	IVR 176 DN 65 + MHP-3SR	1	294,12
417630364	IVR 176 DN 80 + MHP-3,5SR	1	362,23
417640367	IVR 176 DN 100 + MHP-4SR	1	422,59
417650369	IVR 176 DN 125 + MHP-4,5SR	1	553,94
417660371	IVR 176 DN 150 + MHP-5SR	1	633,83
417680376	IVR 176 DN 200 + MHP-6SR	1	1155,51
417690378	IVR 176 DN 250 + MHP-8SR	1	1978,06
417695381	IVR 176 DN 300 + MHP-10SR	1	4063,94



IVR 270



IVR 270 MHP - DA - Attuatori Pneumatici rotanti - DOPPIO EFFETTO
IVR 270 MHP - DA - Pneumatic rotary actuators - DOUBLE ACTING
IVR 270 MHP - DA - Rotierende Drehantriebe - DOPPELWIRKEND
IVR 270 MHP - DA - Actuateurs pneumatiques tournants - DOUBLE EFFET
IVR 270 MHP - DA - Пневматические поворотные приводы - ДВОЙНОГО ДЕЙСТВИЯ

- NOTA: Se si acquistano i prodotti non montati e/o componenti, siete pregati di leggere attentamente le istruzioni riportate nella tabella a pagina 282/283
- NOTE: If you require our products not-assembled and/or just the components, please read the instructions in the table at page 282/283 carefully
- ANMERKUNG: bitte lesen Sie das Schema auf Seite 282/283, wenn Sie die nicht montierte Produkte und/oder nur die Bestandteile einkaufen möchten
- NOTE: Si on veut acheter les produits pas assemblés et/ou seulement les composants, lisez-Vous s'il Vous plaît les instructions dans la table à la page 282/283 attentivement
- ВНИМАНИЕ, при заказе не собранной продукции / о компонентов, Просим Вас посмотреть инструкционную таблицу на 282/283странице.

Cod./Code	Misura/Size	□/田	€
127000031	MHP- 0DA - F03 - Q9	1/18	83,57
127010031	MHP- 1DA - F03 - Q9	1/8	95,18
127010041	MHP-1DA - F04 - Q11	1/8	95,18
127010051	MHP- 1DA - F05 - Q11	1/8	95,18
127020041	MHP- 2DA - F04 - Q11	1/8	106,11
127020051	MHP- 2DA - F05 - Q14	1/8	106,11
127030051	MHP- 3DA - F05 - Q14	1/4	148,28
127030071	MHP- 3DA - F07 - Q17	1/4	147,49
127035071	MHP-3,5DA - F07 - Q17	1/4	192,43
127040071	MHP- 4DA - F07 - Q17	1	228,40
127045071	MHP- 4,5DA - F07	1	311,31
127045101	MHP- 4,5DA - F10 - Q22	1	311,31
127045102	MHP- 4,5DA - F10 - Q17	1	311,31
127050071	MHP- 5DA - F07	1	349,13
127050101	MHP- 5DA - F10 - Q17	1	349,13
127050102	MHP- 5DA - F10 - Q22	1	349,13
127060101	MHP- 6DA - F12 - Q22	1	658,76
127080121	MHP- 8DA - F14 - Q27	1	1226,93

IVR 271



IVR 271 MHP - SR - Attuatori Pneumatici rotanti - SEMPLICE EFFETTO
IVR 271 MHP - SR - Pneumatic rotary actuators - SPRING RETURN
IVR 271 MHP - SR - Rotierende Drehantriebe - EINFACHWIRKEND
IVR 271 MHP - SR - Actuateurs pneumatiques tournants - EFFET SIMPLE
IVR 271 MHP - SR - Пневматические поворотные приводы - ПРОСТОГО ДЕЙСТВИЯ

- NOTA: Se si acquistano i prodotti non montati e/o componenti, siete pregati di leggere attentamente le istruzioni riportate nella tabella a pagina 282/283
- NOTE: If you require our products not-assembled and/or just the components, please read the instructions in the table at page 282/283 carefully
- ANMERKUNG: bitte lesen Sie das Schema auf Seite 282/283, wenn Sie die nicht montierte Produkte und/oder nur die Bestandteile einkaufen möchten
- NOTE: Si on veut acheter les produits pas assemblés et/ou seulement les composants, lisez-Vous s'il Vous plaît les instructions dans la table à la page 282/283 attentivement
- ВНИМАНИЕ, при заказе не собранной продукции / о компонентов, Просим Вас посмотреть инструкционную таблицу на 282/283странице.

Cod./Code	Misura/Size	□/田	€
127110031	MHP- 1SR - F03 - Q9	1/8	122,29
127120031	MHP- 2SR - F03	1/8	136,82
127120041	MHP- 2SR - F04 - Q11	1/8	136,82
127130041	MHP- 3SR - F04	1/8	188,14
127130051	MHP- 3SR - F05 - Q14	1/4	188,93
127135041	MHP- 3,5SR - F04	1/4	245,27
127135051	MHP- 3,5SR - F05 - Q17	1/4	246,09
127135071	MHP- 3,5SR - F07 - Q17	1/4	245,27
127140051	MHP- 4SR - F05	1	287,89
127140071	MHP- 4SR - F07 - Q17	1	287,89
127145071	MHP- 4,5SR - F07 - Q17	1	389,76
127145101	MHP- 4,5SR - F10 - Q17	1	389,76
127150071	MHP- 5SR - F07 - Q17	1	445,73
127150101	MHP- 5SR - F10 - Q17	1	445,73
127155101	MHP- 5,5SR - F10 - Q22	1	581,29
127160101	MHP- 6SR - F10 - Q22	1	856,31
127160121	MHP- 6SR - F12 - Q22	1	856,31
127180101	MHP- 8SR - F10	1	1569,02
127180141	MHP- 8SR - F14 - Q27	1	1569,02
127195121	MHP- 10SR - F12	1	3375,28
127195161	MHP- 10SR - F16 - Q36	1	3375,28



ACCESSORI / RICAMBI
ACCESSORIES / SPARE PARTS
ZUBEHÖR / ERSATZTEILE
ACCESSOIRES / PIÈCES
АКСЕССУАРЫ / ЗАПАСНЫЕ ЧАСТИ

IVR 795



Riduzioni quadre per attuatori pneumatici MHP-DA / SR
Square adapters for pneumatic actuators - MHP-DA / SR
Eckförmige Minderer für pneumatische Antriebe MHP-DA / SR
Réductions quadre pour actuateurs pneumatiques - MHP-DA / SR
Квадратные адаптеры для пневмоприводов - MHP-DA / SR

- NOTA: Se si acquistano i prodotti non montati e/o componenti, siete pregati di leggere attentamente le istruzioni riportate nella tabella a pagina 282/283
- NOTE: If you require our products not-assembled and/or just the components, please read the instructions in the table at page 282/283 carefully
- ANMERKUNG: bitte lesen Sie das Schema auf Seite 282/283, wenn Sie die nicht montierte Produkte und/oder nur die Bestandteile einkaufen möchten
- NOTE: Si on veut acheter les produits pas assemblés et/ou seulement les composants, lisez-Vous s'il Vous plaît les instructions dans la table à la page 282/283 attentivement
- ВНИМАНИЕ, при заказе не собранной продукции / о компонентах, Просим Вас просмотреть инструкционную таблицу на 282/283 странице.

Cod./Code	Misura/Size	□/田	€
503309111	L. 12 - da 9 a 11	10/180	4,88
503311141	L. 16 - da 11 a 14	10/180	4,88
503314171	L. 18 - da 14 a 17	10/180	4,88
503317221	L. 22 - da 17 a 22	10/180	6,56
503322271	L. 28 - da 22 a 27	10/180	6,56

IVR 796



Box micro - tipo meccanico - IP 66
Limit switch box - mechanical type - IP66
Gehäuse Mikroschalter - mechanischer Typ - IP 66
Box micro - type mécanique - IP66
Блок микровыключателей - механического типа - IP66

Cod./Code	Misura/Size	□/田	€
503401001	MBX10EM2	1/8	117,19

IVR 797



Elettrovalvole a singolo o doppio solenoide NAMUR - per attuatori pneumatici a doppio o semplice effetto MHP - DA / SR
Single or double solenoid valve NAMUR - for double acting or spring return pneumatic actuators MHP - DA / SR
Einzel-oder Doppel Solenoidventil NAMUR – für doppeltwirkende oder einfachwirkende rotierende Drehantriebe MHP- DA / SR
Simple ou double electrovannes NAMUR - pour actuateurs pneumatiques double ou simple effet MHP - DA / SR
Одинрный или двойной электроклапан NAMUR - для Пневматических приводов двойного или простого действия MHP- DA / SR

Cod./Code	Misura/Size	□/田	€
503502031	1/4" ELETTR NAMUR 3 vie 1sol. 24V	2/24	136,16
503502051	1/4" ELETTR NAMUR 5 vie 1sol. 24V	2/24	136,16
503502052	1/4" ELETTR NAMUR 5 vie 2sol. 24V	2/24	218,51
503502231	1/4" ELETTR NAMUR 3 vie 1sol. 230V	2/24	136,16
503502251	1/4" ELETTR NAMUR 5 vie 1sol. 230V	2/24	136,16
503502252	1/4" ELETTR NAMUR 5 vie 2sol. 230V	2/24	218,51

- 110 V disponibile su richiesta
110 V available on request
110 V erhältlich auf Anfrage
110 V Disponible sur demande
110 V под заказ



IVR 798 S



Castello + perno per attuatori pneumatici MHP-DA/SR per valvole a sfera
Mounting pad + couplings for pneumatic actuators MHP-DA/SR for ball valves
Halterung + Zapfen für pneumatische Antriebe MHP-DA/SR für Kugelhähne
Châssis + pivot pour actuateurs pneumatiques MHP-DA/SR pour vanne à boisseau sphérique
Кронштейн + соединение для пневмоприводов- MHP-DA / SR для шаровых кранов

Cod./Code	Descrizione/Description	Quadro	ISO 5211	□/田	€
503200001	ADAVS AP0	9 - 9	F03/F03	1	19,69
503205001	ADAVS AP1	9 - 9	F03/F03	1	29,06
503210001	ADAVS AP2	11 - 9	F04/F03	1	38,72
503215001	ADAVS AP3	14 - 9	F05/F04	1	38,72
503215002	ADAVS AP3	14 - 12	F07/F07	1	38,72
503220001	ADAVS AP3,5	17 - 9	F07/F04	1	53,16
503220002	ADAVS AP3,5	17 - 12	F07/F07	1	53,16
503220003	ADAVS AP3,5	17 - 16	F07/F07	1	53,16
503225001	ADAVS AP4	17 - 14	F07/F05	1	53,16
503225002	ADAVS AP4	17 - 12	F07/F10	1	53,16
503225003	ADAVS AP4	17 - 16	F07/F10	1	53,16
503230001	ADAVS AP4,5	22 - 12	F07/F10	1	58,03
503230002	ADAVS AP4,5	22 - 16	F07/F10	1	58,03
503235001	ADAVS AP5	22 - 12	F07/F10	1	58,03
503235002	ADAVS AP5	22 - 16	F07/F10	1	58,03
503240001	ADAVS AP5,5	27 - 16	F07/F12	1	96,66
503240002	ADAVS AP5,5	27 - 18	F07/F12	1	96,66
503240003	ADAVS AP5,5	27 - 22	F07/F12	1	96,66
503245001	ADAVS AP6	27 - 16	F07/F12	1	96,66
503245002	ADAVS AP6	27 - 18	F07/F12	1	96,66
503245003	ADAVS AP6	27 - 22	F07/F12	1	96,66
503250001	ADAVS AP8	36 - 18	F14/F14	1	111,19
503250002	ADAVS AP8	36 - 22	F14/F14	1	111,19

- NOTA: Se si acquistano i prodotti non montati e/o componenti, siete pregati di leggere attentamente le istruzioni riportate nella tabella a pagina 282/283
- NOTE: If you require our products not-assembled and/ or just the components, please read the instructions in the table at page 282/283 carefully
- ANMERKUNG: bitte lesen Sie das Schema auf Seite 282/283, wenn Sie die nicht montierte Produkte und/oder nur die Bestandteile einkaufen möchten
- NOTE: Si on veut acheter les produits pas assemblés et/ ou seulement les composants, lisez-Vous s'il Vous plaît les instructions dans la table à la page 282/283 attentivement
- ВНИМАНИЕ, при заказе не собранной продукции / о компонентов, Просим Вас просмотреть инструкционную таблицу на 282/283странице.

IVR 798 F



Castello + perno per attuatori pneumatici MHP-DA/SR per valvole a farfalla
Mounting pad + couplings for pneumatic actuators MHP-DA/SR for butterfly ball valves
Halterung + Zapfen für pneumatische Antriebe MHP-DA/SR für Kugelhähne mit Flügelgriff
Châssis + pivot pour actuateurs pneumatiques MHP-DA/SR pour vanne à papillon
Кронштейн + соединение для пневмоприводов- MHP-DA / SR для Дискового затвора "Бабочка"

Cod./Code	Descrizione/Description	Quadro	ISO 5211	□/田	€
503271001	ADAVF AP1	9 - 12x9	F05/F05	1	29,06
503272001	ADAVF AP2	11 - 12x9	F05/F05	1	38,72
503273001	ADAVF AP3	14 - 12x9	F05/F05	1	47,16
503273002	ADAVF AP3	14 - 14x11	F05/F07	1	38,72
503274001	ADAVF AP3,5	17 - 12x9	F07/F05	1	53,16
503274002	ADAVF AP3,5	17 - 14x11	F07/F07	1	53,16
503275001	ADAVF AP4	17 - 14x11	F07/F07	1	53,16
503275002	ADAVF AP4	17 - 18x14	F07/F07	1	53,16
503276001	ADAVF AP4,5	17 - 14x11	F010/F07	1	58,03
503277001	ADAVF AP5	17 - 18x14	F010/F07	1	58,03
503277002	ADAVF AP5	17 - 22x17	F010/F10	1	58,03
503279001	ADAVF AP6	22 - 22x17	F012/F10	1	96,66
503279002	ADAVF AP6	22 - 28x22	F012/F10	1	96,66
503280001	ADAVF AP8	27 - 28x22	F014/F10	1	111,19
503280002	ADAVF AP8	27 - 28x22	F014/F12	1	111,19
503281001	ADAVF AP10	36 - 28x22	F016/F12	1	241,69

- NOTA: Se si acquistano i prodotti non montati e/o componenti, siete pregati di leggere attentamente le istruzioni riportate nella tabella a pagina 282/283
- NOTE: If you require our products not-assembled and/ or just the components, please read the instructions in the table at page 282/283 carefully
- ANMERKUNG: bitte lesen Sie das Schema auf Seite 282/283, wenn Sie die nicht montierte Produkte und/oder nur die Bestandteile einkaufen möchten
- NOTE: Si on veut acheter les produits pas assemblés et/ ou seulement les composants, lisez-Vous s'il Vous plaît les instructions dans la table à la page 282/283 attentivement
- ВНИМАНИЕ, при заказе не собранной продукции / о компонентов, Просим Вас просмотреть инструкционную таблицу на 282/283странице.



Articoli/Items	DN	Descrizione/Descriptions	N/m (1)	N/m+coeff. Sicur./ Safety coefficient 25%	Flangia/Flange ISO 5211	Dimensioni asta mm./ Size bar mm.
77-78-82-83	20	Valvola a sfera in ghisa tipo attacchi flangiati PN. 16	16/5	20	F 04	9 a 45°
77-78-82-83	25	Valvola a sfera in ghisa tipo attacchi flangiati PN. 16	20/5	25	F 04	9 a 45°
77-78-82-83	32	Valvola a sfera in ghisa tipo attacchi flangiati PN. 16	25/10	31,25	F 04	9 a 45°
77-78-82-83	40	Valvola a sfera in ghisa tipo attacchi flangiati PN. 16	30/15	37,5	F 05	14 a 45°
77-78-82-83	50	Valvola a sfera in ghisa tipo attacchi flangiati PN. 16	40/20	50	F 05	14 a 45°
77-78-82-83	65	Valvola a sfera in ghisa tipo attacchi flangiati PN. 16	50/25	62,5	F 07	17 a 45°
77-78-82-83	80	Valvola a sfera in ghisa tipo attacchi flangiati PN. 16	80/40	100	F 07	17 a 45°
77-78-82-83	100	Valvola a sfera in ghisa tipo attacchi flangiati PN. 16	120/50	150	F 07	17 a 45°
77-78-82-83	125	Valvola a sfera in ghisa tipo attacchi flangiati PN. 16	140/110	175	F 10	22 a 45°
77-78-82-83	150	Valvola a sfera in ghisa tipo attacchi flangiati PN. 16	150/120	187,5	F 10	22 a 45°
175-176-177-178-276-277-278	40	Valvola a farfalla in ghisa tipo WAFER attacchi angiatati PN. 16	12	15	F 05	12x9
175-176-177-178-276-277-278	50	Valvola a farfalla in ghisa tipo WAFER attacchi angiatati PN. 16	14	17,5	F 05	12 x 9
175-176-177-178-276-277-278	65	Valvola a farfalla in ghisa tipo WAFER attacchi angiatati PN. 16	18	22,5	F 05	12 x 9
175-176-177-178-276-277-278	80	Valvola a farfalla in ghisa tipo WAFER attacchi angiatati PN. 16	26	32,5	F 05	12 x 9
175-176-177-178-276-277-278	100	Valvola a farfalla in ghisa tipo WAFER attacchi angiatati PN. 16	44	55	F 07	14 x 11
175-176-177-178-276-277-278	125	Valvola a farfalla in ghisa tipo WAFER attacchi angiatati PN. 16	78	97,5	F 07	18 x 14
175-176-177-178-276-277-278	150	Valvola a farfalla in ghisa tipo WAFER attacchi angiatati PN. 16	112	140	F 07	18 x 14
176-177-178-276-277-278	200	Valvola a farfalla in ghisa tipo WAFER attacchi angiatati PN. 16	218	272,5	F 10	22 x 17
176-177-178-276-277-278	250	Valvola a farfalla in ghisa tipo WAFER attacchi angiatati PN. 16	385	481,3	F 10	28 x 22
176-177-178-276-277-278	300	Valvola a farfalla in ghisa tipo WAFER attacchi angiatati PN. 16	386	732,5	F 12	28 x 22
144-145	1/4"	INOX Valvola a sfera in acciaio Inox a 3 vie att. F.F. "L". ISO 5211	6/4	7,5	F03/F04	9 a 45°
144-145	3/8"	INOX Valvola a sfera in acciaio Inox a 3 vie att. F.F. "L". ISO 5211	6/4	7,5	F03/F04	9 a 45°
144-145	1/2"	INOX Valvola a sfera in acciaio Inox a 3 vie att. F.F. "L". ISO 5211	6/4	7,5	F03/F04	9 a 45°
144-145	3/4"	INOX Valvola a sfera in acciaio Inox a 3 vie att. F.F. "L". ISO 5211	8/4	10	F04/F05	11 a 45°
144-145	1"	INOX Valvola a sfera in acciaio Inox a 3 vie att. F.F. "L". ISO 5211	13/6	16,25	F04/F05	11 a 45°
144-145	1 1/4"	INOX Valvola a sfera in acciaio Inox a 3 vie att. F.F. "L". ISO 5211	26/14	32,5	F05/F07	14 a 45°
144-145	1 1/2"	INOX Valvola a sfera in acciaio Inox a 3 vie att. F.F. "L". ISO 5211	40/14	50	F05/F07	14 a 45°
144-145	2"	INOX Valvola a sfera in acciaio Inox a 3 vie att. F.F. "L". ISO 5211	70/15	87,5	F05/F07	14 a 45°
665-670-672	1/4"	INOX Valvola a sfera a pass. tot. in 3 p. Inox att. F.F. - B.W. ISO 52	6/3,5	7,5	F 03	9 a 45°
665-670-672	3/8"	INOX Valvola a sfera a pass. tot. in 3 p. Inox att. F.F. - B.W. ISO 52	6/3,5	7,5	F 03	9 a 45°
665-670-672	1/2"	INOX Valvola a sfera a pass. tot. in 3 p. Inox att. F.F. - B.W. ISO 52	8/5	10	F03/F04	9 a 45°
665-670-672	3/4"	INOX Valvola a sfera a pass. tot. in 3 p. Inox att. F.F. - B.W. ISO 52	9/5	11,25	F04/F05	11 a 45°
665-670-672	1"	INOX Valvola a sfera a pass. tot. in 3 p. Inox att. F.F. - B.W. ISO 52	13,5/8	16,9	F04/F05	11 a 45°
665-670-672	1 1/4"	INOX Valvola a sfera a pass. tot. in 3 p. Inox att. F.F. - B.W. ISO 52	20/15	25	F05/F07	14 a 45°
665-670-672	1 1/2"	INOX Valvola a sfera a pass. tot. in 3 p. Inox att. F.F. - B.W. ISO 52	22/16	27,5	F05/F07	14 a 45°
665-670-672	2"	INOX Valvola a sfera a pass. tot. in 3 p. Inox att. F.F. - B.W. ISO 52	25/18	31,25	F05/F07	14 a 45°
665-670-672	2 1/2"	INOX Valvola a sfera a pass. tot. in 3 p. Inox att. F.F. - B.W. ISO 52	60/30	75	F07/F10	17 a 45°
665-670-672	3"	INOX Valvola a sfera a pass. tot. in 3 p. Inox att. F.F. - B.W. ISO 52	75/35	93,75	F07/F10	17 a 45°
665-670-672	4"	INOX Valvola a sfera a pass. tot. in 3 p. Inox att. F.F. - B.W. ISO 52	110/60	137,5	F07/F10	17 a 45°
685	15	INOX Valvole a sfera tipo WAFER att. . PN. 16 INOX AISI 316	5/2	6,25	F03/F04	9 a 45°
685	20	INOX Valvole a sfera tipo WAFER att. . PN. 16 INOX AISI 316	8/3	10	F03/F04	9 a 45°
685	25	INOX Valvole a sfera tipo WAFER att. . PN. 16 INOX AISI 316	10/5	12,5	F04/F05	11 a 45°
685	32	INOX Valvole a sfera tipo WAFER att. . PN. 16 INOX AISI 316	14/7	17,5	F04/F05	11 a 45°
685	40	INOX Valvole a sfera tipo WAFER att. . PN. 16 INOX AISI 316	24/15	30	F05/F07	14 a 45°
685	50	INOX Valvole a sfera tipo WAFER att. . PN. 16 INOX AISI 316	26/16	32,5	F05/F07	14 a 45°
685	65	INOX Valvole a sfera tipo WAFER att. . PN. 16 INOX AISI 316	100/35	125	F07/F10	17 a 45°
685	80	INOX Valvole a sfera tipo WAFER att. . PN. 16 INOX AISI 316	140/40	175	F07/F10	17 a 45°
685	100	INOX Valvole a sfera tipo WAFER att. . PN. 16 INOX AISI 316	230/110	287,5	F07/F10	17 a 45°
230-231-232-233	1/2"	Valvola a sfera a pass. tot. in OTTONE F.F. - M.F. - M.M. - C.C.	2/1	2,5	F 03	9 a 45°
230-231-232-233	3/4"	Valvola a sfera a pass. tot. in OTTONE F.F. - M.F. - M.M. - C.C.	4/3	5	F 03	9 a 45°
230-231-232-233	1"	Valvola a sfera a pass. tot. in OTTONE F.F. - M.F. - M.M. - C.C.	5/3	6,25	F 03	9 a 45°
230	1 1/4"	Valvola a sfera a pass. tot. in OTTONE F.F. - M.F. - M.M. - C.C.	7/4	8,75	F 04	11 a 45°
230	1 1/2"	Valvola a sfera a pass. tot. in OTTONE F.F. - M.F. - M.M. - C.C.	8/4	10	F 04	11 a 45°
230	2"	Valvola a sfera a pass. tot. in OTTONE F.F. - M.F. - M.M. - C.C.	11/5	13,75	F 04	11 a 45°

(1) Il primo valore si riferisce alla coppia di spunto, il secondo di manovra e sono espressi in (Nm). Attenzione i valori possono differire a seconda del tipo di utilizzo.

(1) The first value refers to the starting torque, the second value is the working torque (Nm). Warning: the values can vary according to their use.

(1) Der erste Wert bezieht sich auf das Drehmoment, der zweite Wert auf das Betätigungsmoment (Nm). ACHTUNG: diese Werte können nach dem Einsatzgebiet verschieden sein.

(1) La première valeur se réfère à la couple de départ, la deuxième à la couple de manoeuvre (Nm). ATTENTION: les valeurs peuvent varier selon l'utilisation du produit.

(1) Первое значение относится к пусковой фазе, второе к рабочей крутящейся. Значения выражены в единицах измерения (Нм).

Внимание: данные могут отличаться в зависимости от сферы применения.



Attuatori DA da utilizzare/Actuators DA to use	ISO ☒	☒ Riduzione/Adapters	perno+castelletto/coupling+bracket	Attuatori SR da utilizzare/Actuators SR to use	ISO ☒	☒ Riduzione/Adapters	perno+castelletto/coupling+bracket
MHP-2DA	F04 - ☒ 11	n° 1 (11>9)		MHP-3SR	F05 - ☒ 14		Q 14/9 - F05/F04
MHP-2DA	F04 - ☒ 11	n° 1 (11>9)		MHP-3SR	F05 - ☒ 14		Q 14/9 - F05/F04
MHP-2DA	F04 - ☒ 11	n° 1 (11>9)		MHP-3,5SR	F07 - ☒ 17		Q 17/9 - F07/F04
MHP-3DA	F05 - ☒ 14			MHP-3,5SR	F05 - ☒ 17	n° 1 (17>14)	
MHP-3DA	F05 - ☒ 14			MHP-4SR	F07 - ☒ 17		Q 17/14 - F07/F05
MHP-3DA	F07 - ☒ 17			MHP-4,5SR	F07 - ☒ 17		
MHP-3,5DA	F07 - ☒ 17			MHP-4,5SR	F07 - ☒ 17		
MHP-4DA	F07 - ☒ 17			MHP-5SR	F07 - ☒ 17		
MHP-4,5DA	F10 - ☒ 22			MHP-5,5SR	F10 - ☒ 22		
MHP-4,5DA	F10 - ☒ 22			MHP-6SR	F10 - ☒ 22		
MHP-1DA	F05 - ☒ 9		Q 9/12X9 F05/F05	MHP-3SR	F05 - ☒ 14		Q 9/12X9 F05/F05
MHP-1DA	F05 - ☒ 9		Q 9/12X9 F05/F05	MHP-3SR	F05 - ☒ 14		Q 9/12X9 F05/F05
MHP-2DA	F05 - ☒ 11		Q 11/12X9 F05/F05	MHP-3SR	F05 - ☒ 14		Q 11/12X9 F05/F05
MHP-3DA	F05 - ☒ 14		Q 14/12X9 F05/F05	MHP-3,5SR	F07 - ☒ 17		Q 14/12X9 F07/F05
MHP-3DA	F05 - ☒ 14		Q 14/12X9 F05/F07	MHP-4SR	F07 - ☒ 17		Q 14/14X11 F07/F07
MHP-3,5DA	F07 - ☒ 17		Q 17/18X14 F07/F07	MHP-4,5SR	F10 - ☒ 17		Q 17/18X14 F07/F07
MHP-4DA	F07 - ☒ 17		Q 17/18X14 F07/F07	MHP-5SR	F10 - ☒ 17		Q 17/18X14 F10/F07
MHP-5DA	F10 - ☒ 17		Q 17/22X17 F10/F10	MHP-6SR	F12 - ☒ 22		Q 22/22X17 F12/F10
MHP-6DA	F12 - ☒ 22		Q 22/28X22 F12/F10	MHP-8SR	F14 - ☒ 27		Q 27/28X22 F14/F10
MHP-8DA	F14 - ☒ 27		Q 27/28X22 F14/F12	MHP-10SR	F16 - ☒ 36		Q 36/28X22 F16/F12
MHP-0DA	F03 - ☒ 9			MHP-1SR	F03 - ☒ 9		
MHP-0DA	F03 - ☒ 9			MHP-1SR	F03 - ☒ 9		
MHP-0DA	F03 - ☒ 9			MHP-1SR	F03 - ☒ 9		
MHP-1DA	F05 - ☒ 11			MHP-2SR	F04 - ☒ 11		
MHP-1DA	F05 - ☒ 11			MHP-2SR	F04 - ☒ 11		
MHP-2DA	F05 - ☒ 14			MHP-3SR	F05 - ☒ 14		
MHP-3DA	F05 - ☒ 14			MHP-3,5SR	F07 - ☒ 17	n° 1 (17>14)	
MHP-3,5DA	F07 - ☒ 17	n° 1 (17>14)		MHP-4SR	F07 - ☒ 17	n° 1 (17>14)	
MHP-0DA	F03 - ☒ 9			MHP-1SR	F03 - ☒ 9		
MHP-0DA	F03 - ☒ 9			MHP-1SR	F03 - ☒ 9		
MHP-1DA	F03 - ☒ 9			MHP-2SR	F04 - ☒ 11	n° 1 (11 > 9)	
MHP-1DA	F05 - ☒ 11			MHP-2SR	F04 - ☒ 11		
MHP-1DA	F05 - ☒ 14			MHP-3SR	F05 - ☒ 14	n° 1 (14 > 11)	
MHP-2DA	F05 - ☒ 14			MHP-3SR	F05 - ☒ 14		
MHP-2DA	F05 - ☒ 14			MHP-3,5SR	F07 - ☒ 17	n° 1 (17>14)	
MHP-1DA	F05 - ☒ 14			MHP-3,5SR	F07 - ☒ 17	n° 1 (17>14)	
MHP-3,5DA	F07 - ☒ 17			MHP-4,5SR	F10 - ☒ 17		
MHP-3,5DA	F07 - ☒ 17			MHP-4,5SR	F10 - ☒ 17		
MHP-4DA	F07 - ☒ 17			MHP-5SR	F10 - ☒ 17		
MHP-0DA	F03 - ☒ 9			MHP-1SR	F03 - ☒ 9		
MHP-1DA	F03 - ☒ 9	n° 1 (11>9)		MHP-2SR	F04 - ☒ 11	n° 1 (11 > 9)	
MHP-1DA	F05 - ☒ 11			MHP-3SR	F05 - ☒ 14	n° 1 (14 > 11)	
MHP-1DA	F05 - ☒ 11			MHP-3SR	F05 - ☒ 14	n° 1 (14 > 11)	
MHP-2DA	F05 - ☒ 14			MHP-3,5SR	F07 - ☒ 17	n° 1 (17>14)	
MHP-3DA	F05 - ☒ 14			MHP-3,5SR	F07 - ☒ 17	n° 1 (17>14)	
MHP-4DA	F07 - ☒ 17			MHP-5SR	F10 - ☒ 17		
MHP-4,5DA	F10 - ☒ 17			MHP-5,5SR	F10 - ☒ 22	n° 1 (22>17)	
MHP-5DA	F10 - ☒ 17			MHP-6SR	F10 - ☒ 22	n° 1 (22>17)	
MHP-0DA	F03 - ☒ 9			MHP-1SR	F03 - ☒ 9		
MHP-0DA	F03 - ☒ 9			MHP-1SR	F03 - ☒ 9		
MHP-0DA	F03 - ☒ 9			MHP-1SR	F03 - ☒ 9		
MHP-1DA	F04 - ☒ 11			MHP-2SR	F04 - ☒ 11		
MHP-1DA	F04 - ☒ 11			MHP-2SR	F04 - ☒ 11		
MHP-1DA	F04 - ☒ 11			MHP-2SR	F04 - ☒ 11		



CONDIZIONI DI VENDITA

Premessa - I contratti di vendita stipulati da IVR S.p.A. (di seguito denominata "Azienda") sono regolati dalle presenti condizioni generali di contratto, salvo deroghe risultanti da esplicito accordo scritto ed espressamente approvate per iscritto dall'Azienda. Le presenti condizioni generali di vendita si intendono integralmente lette ed accettate dal compratore con il conferimento dell'ordine di acquisto.



Ordini - Gli ordini o gli impegni assunti dai rappresentanti, agenti o altri ausiliari dell'Azienda non hanno in alcun modo potere di vincolare l'Azienda medesima; ne consegue che tutti gli ordini effettuati dai predetti rappresentanti, agenti e ausiliari acquistano validità ed efficacia solo con la conferma scritta dell'Azienda e l'approvazione scritta dell'Ufficio commerciale dell'Azienda. Qualsiasi modifica dell'ordine sarà valida solo previa conferma scritta ed approvazione scritta dell'Ufficio commerciale dell'Azienda. Gli ordini verranno evasi solo per confezioni complete e con importo minimo di 500,00 € netto merce.

Prezzi - I prezzi si ritengono validi solo dopo nostra conferma scritta. La merce è venduta ai prezzi del listino in vigore al momento del conferimento dell'ordine.

Consegna - Eventuali ritardi dovuti a problemi di fabbricazione compresa mancanza di materie prime, avarie di macchinari, scioperi o forza maggiore non danno alcun diritto al Committente di ritardare i pagamenti, annullare l'ordine confermato o reclamare danni di qualsiasi natura.

Spedizioni - La merce normalmente viaggia in Porto Assegnato, quindi a rischio e pericolo del Cliente. Non si risponde degli eventuali ritardi, avarie o ammanchi verificatisi durante il viaggio. Le indicazioni del Committente in ordine al mezzo di spedizione hanno valore di semplice raccomandazione e verranno seguite al limite delle possibilità operative; in caso contrario verrà utilizzato il mezzo disponibile al momento senza alcun avviso.

Quantità - Gli ordini verranno evasi solo per confezioni complete.

Illustrazioni - Gli articoli nelle forme e colori riportati nei cataloghi sono solo rappresentativi e non vincolanti la produzione alla fedele esecuzione. IVR S.p.A. si riserva il diritto di apportare modifiche di natura tecnica, estetica e commerciale senza alcun obbligo di preavviso.

Reclami - Non si accettano reclami trascorsi 5 giorni lavorativi dalla data di ricevimento della merce. I reclami devono essere effettuati per iscritto e recapitati presso la nostra sede.

Resi - Non si accettano resi senza la previa autorizzazione scritta dell'Azienda. La merce deve essere resa in Porto Franco nelle medesime condizioni in cui il compratore l'aveva ricevuta.

Responsabilità - Tutti i prodotti vengono collaudati prima di essere posti in vendita. Eventuali articoli con difetti di fabbricazione da noi riconosciuti verranno gratuitamente sostituiti dopo aver ricevuto di ritorno in porto franco il pezzo contestato. Non verranno riconosciuti altri indennizzi né rimborsi spese per le conseguenze derivanti dall'impiego, installazioni e sostituzioni di nostri materiali.

Pagamenti - La condizione di pagamento è quella indicata in fattura. Trascorse le scadenze convenute, senza alcun avviso, verranno calcolati gli interessi di mora, secondo il tasso vigente. Eventuali spese bancarie verranno addebitate al cliente.

Forniture di prodotti OEM / Speciali / Personalizzati - Qualora oggetto della vendita siano prodotti riportanti un marchio di proprietà del Cliente, quest'ultimo deve garantire la piena e incondizionata titolarità del marchio stesso e autorizzare IVR S.p.A. a utilizzare il marchio al fine di realizzare i prodotti oggetto della fornitura. Il Cliente si impegna a manlevare e tenere indenne IVR S.p.A. da ogni e qualsiasi pretesa o azione anche di terzi al riguardo. È onere e responsabilità esclusiva del Cliente determinare e comunicare le caratteristiche tecniche e le informazioni da riportare sulla confezione del prodotto finito, con esplicito riferimento, tra l'altro, a eventuali normative, regolamenti, prassi e usi locali o internazionali in merito all'origine, alla provenienza, alle caratteristiche tecniche dei prodotti e alla tracciabilità degli stessi, ecc. Il Cliente si impegna a manlevare e tenere indenne IVR S.p.A. da ogni e qualsiasi pretesa o azione di terzi al riguardo o da sanzioni eventualmente irrogate in conseguenza del mancato o inesatto ottemperamento a quanto sopra previsto.

Il prezzo di vendita dei prodotti OEM al Cliente sarà quello indicato di volta in volta nella conferma d'ordine inviata da IVR S.p.A. per la singola fornitura; eventuali listini o offerte inviati hanno unicamente valore indicativo e non sono in alcun modo vincolanti per IVR S.p.A.

Resta inteso che il Cliente si impegna a ritirare tutti i prodotti ordinati e realizzati con il proprio marchio, IVR S.p.A. sarà autorizzata a fatturare gli stessi trascorso il termine di 90 giorni dalla messa a disposizione della merce.

Controversie - Il foro competente è sempre e solo quello di Novara.

GENERAL SALES CONDITIONS



Introduction - The sales contracts stipulated by IVR S.p.A. (hereinafter the "Company") are governed by these general terms and conditions, unless exceptions resulting from explicit written agreement approved in writing by the Company. These general conditions of sale are considered fully read and accepted by the buyer with the confirmation of the purchase order.

Orders - Orders taken by representatives, agents or other auxiliary of the Company does not in any way have authority to bind the company itself; all orders made by the above mentioned representatives, agents and auxiliaries become valid and effective only with the written confirmation of the Company. Any modification of the order will be valid only after written confirmation and written approval of the Company. Orders will be processed only for complete box packages and with goods minimum amount of 500,00 € net.

Price - Prices are validated by our written confirmation. Goods are sold according to the price list in use on the order date.

Transport - Delay due to manufacturing problems including lack of raw materials, machinery breakdowns, strikes or force majeure do not give any right to the customer to delay payments, cancel orders already confirmed or claim damages of any kind.

Delivery - The goods are transported at the Purchaser's own risk. IVR will not accept to be held responsible for delays, malfunctions and damage occurred during the transport of the goods. The Purchaser's indications regarding the means of transport to be used are to be considered as suggestions and will be followed as precisely as possible; if not the most convenient alternative will be used without prior notice.

Quantity - Ordered goods will be dispatched according to complete box quantities.

Pictures - The pictures of the items in the catalogue are purely representative of the product, variations can take place in any moment. IVR S.p.A. reserves the right to make technical changes, aesthetic and commercial without any prior notice.

Claims - Complaints are not accepted after 5 working days from the date of receipt of goods. Claims must be made in writing and delivered at our address.

Returns - Returns of goods are not accepted without the prior written permission of the Company. The goods must be delivered DAP at the Company address and must be un-used and in good conditions.

Liability - All goods undergo a quality test before being sold. In case of proved defects admitted by IVR, goods will be replaced without additional costs after authorized receipt of the faulty goods. No additional costs, such as any kind of refund due to damage, caused by the faulty goods or installations and replacement expenses, will be accepted.

Payment - The condition of payment is indicated in the invoice. After the expiry date, without any warning, interest will be calculated according to the rate in force. In case of bank charges, these will be billed to the customer.

Supplies of OEM / Special / Customized products - If the subject of the sale are products bearing a trademark owned by the client, the latter shall ensure the full and unconditional ownership of the trademark and authorize IVR S.p.A. to use the trademark in order to make the products to be supplied. The Customer agrees to indemnify and hold harmless IVR S.p.A. from any and all third party claims or actions in the regard.

It is Customer's liability and sole responsibility to determine and communicate the technical specifications and the information on the packaging of the finished products, with the specific reference to any laws, regulations, practices and local or international custom about origin, provenance, product specification and traceability of the same, etc... The Customer agrees to indemnify and hold harmless IVR S.p.A. from any and all claims or actions of third parties in this regard or any penalties applied as a result of failure or incorrect application to the above.

The price of OEM products will be shown in the order confirmation sent by IVR S.p.A. and are related just to a specific delivery and does not bind IVR S.p.A. for longer periods, unless a different agreement is in place.

It is understood that the Customer agree to collect all OEM products ordered and manufactured, IVR S.p.A. will be entitled to invoice the same after 90 days from the provision of goods.

Disputes - Disputes will be settled by the court of Novara.

CONDIZIONI DI GARANZIA

GENERAL WARRANTY CONDITIONS

I prodotti fabbricati da IVR S.p.A. sono garantiti per due anni dalla data di spedizione dai propri stabilimenti. La presente garanzia si aggiunge e non pregiudica i diritti dell'acquirente previsti dalla Direttiva Europea 99/44/CE e relativo decreto nazionale di attuazione, salvo in casi ove diversamente specificato.



Sono esclusi dalla presente garanzia, i guasti e gli eventuali danni causati da:

- **Trasporto non effettuato a cura dell'Azienda.**
- **Inosservanza delle istruzioni e delle avvertenze previste dal produttore e riportate sui manuali, istruzioni e/o cataloghi dei prodotti.**
- **Inosservanza di norme e/o disposizioni previste da leggi e/o regolamenti vigenti.**
- **Assenza o difetto di manutenzione periodica, trascuratezza, incapacità d'uso, manomissioni.**
- **Errata installazione e/o anomalie di qualsiasi genere nell'alimentazione degli impianti idraulici, elettrici, di erogazione del combustibile e/o scarichi.**
- **Inadeguati trattamenti dell'acqua di alimentazione, trattamenti disincrostanti erroneamente effettuati.**
- **Corrosione causata dall'aggressività dell'acqua o da condensa.**
- **Gelo, correnti vaganti, e/o effetti dannosi di scariche atmosferiche.**
- **Sostituzioni preventive.**
- **Cause di forza maggiore indipendenti dalla volontà e dal controllo dell'Azienda produttrice.**

Gli eventuali difetti nei materiali, o vizi occulti, come pure gli errori, le differenze nelle dimensioni eccedenti le normali tolleranze di fabbricazione impegneranno l'Azienda alla sola sostituzione dei pezzi difettosi.

Eventuali resi di merce non conforme verranno accettati solo con preventiva autorizzazione scritta (autorizzazione al reso) da parte dei Responsabili Commerciali dell'Azienda. In ogni caso la merce resa dovrà pervenire presso gli stabilimenti dell'Azienda in porto franco. Diversamente la merce sarà respinta al mittente.

Ogni eventuale reso di materiale conforme deve essere preventivamente concordato con la Direzione Commerciale dell'Azienda. I costi di trasporto saranno a carico del cliente.

La copertura assicurativa ha durata di dieci anni dalla data di spedizione dagli stabilimenti dell'Azienda.

Solo nel caso di messa in opera di prodotti non conformi dell'Azienda e di danni a persone o a cose involontariamente causati da questi, essa incaricherà la propria Compagnia d'Assicurazione di procedere a norma di polizza. Per aprire il sinistro con la Compagnia d'Assicurazione, l'Azienda deve ricevere denuncia del sinistro entro 10 giorni dall'evento, pena il mancato risarcimento, e tutti i dati dello stesso su apposito questionario con allegati documenti e campioni necessari per la gestione della pratica di risarcimento, entro termine di 30 gg.

Nessun rimborso sarà riconosciuto al Cliente prima che l'Azienda abbia verificato la causa del reclamo e/o del danno.

Nel caso in cui siano necessari o richiesti dei test di laboratorio per la verifica, ricerca, definizione della non conformità di un reso/reclamo/sinistro, ove la stessa non risultasse imputabile a responsabilità dell'Azienda, i costi sostenuti saranno addebitati al richiedente. Gli installatori devono effettuare e documentare le prove sugli impianti secondo le normative internazionali vigenti, in Italia come prescritto dal DM 37/08, e la norma UNI 9182.

Any product produced by IVR S.p.A. is covered by a 2 year warranty from the delivery date from the factory. This warranty is an addition, and does not affect the buyer's rights under the European Directive 99/44/CE and the related national implementing decree, except where otherwise noted.



We exclude from this warranty defects and damage caused by:

- **Transport not arranged by the Company.**
- **Failure to comply with the instructions and warnings provided by the manufacturer and found in the manuals, instructions and/or product catalogs.**
- **Disregard of standards and/or provisions of laws and / or regulations.**
- **Absence, or lack of, maintenance, neglect, inability to use, tampering.**
- **Incorrect installation and/or anomalies of any kind in supplying plumbing, electrical, fuel dispensing and/or draining systems.**
- **Corrosion caused by aggression or water condensation.**
- **Frost, stray currents, and/or harmful effects of lightning and storms.**
- **Preventive replacements.**

In case of material defects, or hidden faults, as well as mistakes or differences in dimensions exceeding normal manufacturing tolerances, the Company will only replace the faulty pieces.

Any eventual return of non-conforming goods will be accepted only against a prior written authorization by Commercial Directors ("Return Authorization"). In any case the returned goods shall have to reach the Company's warehouse free of any transport costs, otherwise the goods will be rejected and returned to the sender.

Any return of compliant material must have first been agreed with the Company's Business/Sale Management. Customers shall pay for freight costs. Insurance cover lasts ten years from the delivery date from our factory.

In case the Company's installed non-conforming products accidentally caused damage to things or people, the Company will call upon its Insurer in order to treat the accident according to its policy. To be able to start the claim with the Insurance, the Company must receive the complaint form within 10 days of the accident occurring, or a non-compensation penalty will apply. A specific questionnaire must be duly filled within 30 days, including all the accident details, relevant documentation, and samples of the faulty articles which are necessary to complete the compensation file.

No reimbursement will be allowed until the Company has verified the causes of claim and/or damage.

Should laboratory tests become necessary, the costs incurred whilst checking and defining the non conformity of a claim or return or damage, will be charged to the customer, if the fault can't be attributed to the Company.

The installers must perform and document tests on systems in accordance with international regulations in force in Italy as required by the law DM 37/08 and the regulation UNI 9182.

AL MOMENTO DELL'ORDINE SI PREGA DI INDICARE SEMPRE IL CODICE ARTICOLO



* Disponibile su richiesta | Confezione: quantità per scatola - quantità per cartone | I prezzi si riferiscono al singolo pezzo

ASSORTIMENTI, CARATTERISTICHE E PREZZI DEI PRODOTTI POSSONO ESSERE SOGGETTI A VARIAZIONI SENZA PREAVVISO

SERVOCOMANDI E VALVOLE MOTORIZZABILI

IMPIEGHI: Impianti di riscaldamento a zone - impianti di refrigerazione con glicole - impianti industriali e di irrigazione

VALVOLE ACQUA

Ref.: Articoli | Valvola a sfera in ottone sgrassata per ossigeno: aumento prezzo 5% | Valvola a sfera con filettatura NPT: aumento prezzo 10% | Valvola a sfera con maniglia in DACROMET: aumento prezzo 3%

VALVOLE GAS

Ref.: Articoli 82-83 | Valvola a sfera flangiata in ghisa con O-RING in VITON: disponibile su richiesta

VALVOLE INDUSTRIA

Ref.: Articoli 77-78-80-81 | Valvola a sfera flangiata in ghisa con O-RING in VITON: disponibile su richiesta

Ref.: Articoli INOX | Valvola con filettatura NPT: disponibile su richiesta

Ref.: Articoli - ATTUATORI ELETTRICI | Su richiesta alimentazione a 60 Hz

Ref.: Articoli - ATTUATORI PNEUMATICI | Tutti gli attuatori MHP DA / SR assemblati sulle valvole sono stati calcolati per utilizzo con pressione 6 bar / 87 p.s.i.

| Gli attuatori MHP-SR a semplice effetto sono forniti con 6 molle per ciascun lato delle testate

PLEASE INDICATE ITEM CODE ON ORDERS



* Available on request | Packaging: quantity per box - quantity per master carton | The prices refer to the single piece

PRODUCT FEATURES AND PRICES CAN CHANGE WITHOUT NOTICE

ACTUATORS AND MOTORIZED VALVES

GENERAL USE: zone heating system - glycol refrigeration system - industrial system general - irrigation system

WATER VALVES

Ref.: Items | Degreased brass ball valve suitable for oxygen: 5% price increase | Ball valve with threaded ends NPT: 10% price increase | Ball valve with DACROMET handle: 3% price increase

GAS VALVES

Ref.: Items 82-83 | Cast iron ball valve with VITON O-RING: available on request

INDUSTRY VALVES

Ref.: Items 77-78-80-81 | Cast iron ball valve with VITON O-RING: available on request

Ref.: Items INOX | Ball valve with threaded ends NPT: available on request

Ref.: Items - ELECTRICAL ACTUATORS | Electrical power supply at 60 Hz available on request

Ref.: Items - PNEUMATIC ACTUATORS | All actuators MHP DA / SR assembled on the valve are calculated for 6 bar / 87 p.s.i. operating pressure | The pneumatic spring return actuators are supplied with six springs on each side of cap.

BEI DER BESTELLUNG BITTE IMMER DIE ARTIKEL-NUMMER ANGEBEN



* Erhältlich auf Anfrage | Verpackung: Menge pro Schachtel - Menge pro Karton | Die Preise verstehen sich pro Stück

DIE MERKMALE UND PREISE DER ARTIKEL KÖNNEN OHNE VORANKÜNDIGUNG ÄNDERUNGEN UNTERLIEGEN

SERVOSTEUERUNGEN UND MOTORISIERBARE KUGELHÄHNE

VERWENDUNGSGEBIETE: Zonenheizanlagen – Kühlanlagen mit Glykohl – Industrie- und Bewässerungsanlagen

WASSERKUGELHÄHNE

Ref.: Artikel | Kugelhahn aus Messing, entfettet für Sauerstoff: Aufpreis 5 % | Kugelhahn mit NPT-Gewinde: Aufpreis 10 % | Kugelhahn mit Griff aus DACROMET: Aufpreis 3 %

GASKUGELHAHN

Ref.: Artikel 82-83 | Flansch-Kugelhahn aus Gusseisen mit O-RING aus VITON: erhältlich auf Anfrage

INDUSTRIEKUGELHÄHNE

Ref.: Artikel 77-78-80-81 | Flansch-Kugelhahn aus Gusseisen mit O-RING aus VITON: erhältlich auf Anfrage

Ref.: Artikel INOX | Kugelhahn mit NPT-Gewinde: erhältlich auf Anfrage

Ref.: Artikel - ELEKTRISCHE ANTRIEBE | Auf Anfrage mit 60 Hz Versorgung

Ref.: Artikel - PNEUMATISCHE ANTRIEBE | Alle mit den Kugelhähne zusammengebauten Antriebe MHP DA / SR wurden für die Anwendung mit einem Druck von 6 bar / 87 p.s.i. bemessen | Die einfachwirkenden Antriebe MHP-SR sind mit 6 Federn pro Kopfseite ausgestattet

LORS DE LA COMMANDE, VEUILLEZ TOUJOURS INDIQUER LE CODE ARTICLE



* Disponible sur demande | Emballage: quantité par boîte - quantité par carton | Les prix se réfèrent à chaque pièce

LES CARACTÉRISTIQUES ET LES PRIX DES PRODUITS PEUVENT ÊTRE SOUMIS À DES VARIATIONS SANS PRÉAVIS

SERVOCOMMANDES ET VANNES MOTORISABLES

UTILISATIONS : Systèmes de chauffage à zones - systèmes de réfrigération au glycol - systèmes industriels et d'irrigation

VANNES EAU

Réf.: Articles | Vanne à boisseau sphérique en laiton dégraissée pour oxygène: augmentation du prix de 5% | Vanne à boisseau sphérique avec filetage NPT: augmentation du prix de 10% | Vanne à boisseau sphérique avec poignée en DACROMET: augmentation du prix de 3%

VANNES GAZ

Réf.: Articles 82-83 | Vanne à boisseau sphérique bride en fonte avec O-RING en VITON: disponible sur demande

VANNES INDUSTRIE

Réf.: Articles 77-78-80-81 | Vanne à boisseau sphérique bride en fonte avec O-RING en VITON: disponible sur demande

Réf.: Articles INOX | Vanne avec filetage NPT: disponible sur demande

Réf.: Articles - ACTUATEURS ÉLECTRIQUES | Sur demande alimentation à 60 Hz

Réf.: Articles - ACTUATEURS PNEUMATIQUES | Tous les actionneurs MHP DA / SR assemblés sur les vannes ont été calculés pour une utilisation avec une pression de 6 bars/ 87 p.s.i. | Les actionneurs MHP-SR à effet simple sont fournis avec 6 ressorts de chaque côté des têtes

ПРИ ЗАКАЗЕ НЕОБХОДИМО УКАЗАТЬ КОД ИЗДЕЛИЯ



* Под заказ | Упаковка: Количество в коробке - Количество в большой коробке | Указанная цена относится к единице изделия

ХАРАКТЕРИСТИКИ И ЦЕНА ИЗДЕЛИЯ МОГУТ БЫТЬ ИЗМЕНЕНЫ БЕЗ ПРЕДВАРИТЕЛЬНОГО ПРЕДУПРЕЖДЕНИЯ

ЭЛЕКТРИЧЕСКИЕ И ПНЕВМАТИЧЕСКИЕ ПРИВОДЫ

ПРИМЕНЕНИЕ: Системы отопления по зонам – системы гликолевого охлаждения – промышленные и ирригационные системы

ЗАПОРНАЯ АРМАТУРА ДЛЯ ВОДЫ

Réf.: Изделия | Латунный шаровой кран без смазки (для кислорода): цена выше на 5% | Шаровой кран с резьбовым соединением NPT: цена выше на 10% | Шаровой кран с ручкой DACROMET: цена выше на 3%

ЗАПОРНАЯ АРМАТУРА ДЛЯ ГАЗА

Réf.: Изделия 82-83 | Чугунный шаровой кран с O-кольцом VITON: под заказ

ИНДУСТРИАЛЬНАЯ ЗАПОРНАЯ АРМАТУРА

Réf.: Изделия 77-78-80-81 | Чугунный шаровой кран с O-кольцом VITON: под заказ

Réf.: Изделия из нержавеющей стали INOX | Шаровой кран с резьбовым соединением NPT: под заказ

Réf.: Изделия - ЭЛЕКТРОПРИВОДЫ | Электропитание с частотой 60Гц: под заказ

Réf.: Изделия - ПНЕВМОПРИВОДЫ | Все приводы MHP DA / SR, монтируемые на клапаны, рассчитаны для работы с давлением в 6 bar / 87 p.s.i. | Приводы простого действия поставляются с шестью пружинами на каждой стороне.

IVR S.p.A.

Via Brughiera III, 1 - Località Piano Rosa
28010 Boca (No) Italy

Tel. +39 0322 888811 - Fax +39 0322 888892
Email: vendite@ivrvalvole.it | sales@ivrvalvole.it
www.ivrvalvole.it

