

RISCALDAMENTO
HEATING
HEIZUNG
CHAUFFAGE
ОБОРУДОВАНИЕ ДЛЯ СИСТЕМ ОТОПЛЕНИЯ





Collettori Manifolds

| | |
|---|-------|
| Collettori Inox - AvantFloor / Inox Manifolds - AvantFloor | p. 5 |
| Multiklima distribuzione / Multiklima distribution | p. 21 |
| Gruppi di miscelazione / Mixing units | p. 31 |
| Collettori Inox - AvantFloor - Accessori / Inox Manifolds AvantFloor - Accessories | p. 34 |
| Collettori Industriali - IVR Inox / Industrial Manifolds - IVR Inox | p. 42 |
| Collettori Industriali - IVR Inox - Accessori / Industrial Manifolds - IVR Inox - Accessories | p. 46 |
| Collettori in Ottone - SunnyFloor / Brass Manifolds - SunnyFloor | p. 48 |



IVR Multiklima

| | |
|---|-------|
| Multiklima contabilizzazione / Multiklima energy metering | p. 58 |
|---|-------|



Valvole per radiatori Radiator valves

| | |
|---|--------|
| Valvole Termostatiche / Thermostatic Valves | p. 65 |
| Kit termostatici - Thermostatic kits | p. 81 |
| Valvole Manuali / Manual Valves | p. 86 |
| Valvole ad "H" / "H" valves | p. 97 |
| Valvole Fan-coil / Fan-coil valves | p. 99 |
| Adattatori / Adapters | p. 100 |



Componenti centrale termica Components for Central Heating System

| | |
|---|--------|
| Gruppo Alimentazione / Automatic filling unit | p. 101 |
| Valvole di bilanciamento / Balancing valves | p. 102 |
| Gruppi valvole di Sicurezza e scarico caldaia / Safety Valves | p. 104 |
| Rubinetti scarico caldaia / Boiler blow-off valves | p. 108 |

COLLETTORI / MANIFOLDS

Collettori Inox / Inox Manifolds
AVANT FLOOR



Collettore in acciaio inox AISI 304 1" - 1"1/4; Connessioni 3/4" EK - Zanche di fissaggio antivibrazione - Interasse 50 mm - Etichette e istruzioni
AISI 304 stainless steel manifold 1" - 1"1/4; 3/4" Eurocone connections - Mounting brackets which minimise noise and vibration - Centre hole distance 50 mm - Stickers and assembly instruction

Verteiler aus rostfreiem Edelstahl AISI 304 mit 1" - 1" 1/4; 3/4" Anschlüssen Eurokonus, schwingungsdämpfenden Befestigungs-Klammern, Abstand 50 mm - Etiketten und Anweisungen

Collecteur en acier inox AISI 304 1" - 1"1/4; fixations 3/4" EK. Plaques d'ancrage antivibration Entraxes 50 mm Étiquettes et instructions

Коллектор из нержавеющей стали AISI 304, размеры 1" - 1"1/4; 3/4", соединения Евроконус, межосевое расстояние 50 мм, крепления с защитой от вибрации, инструкция по сборке

KIT A 802 IVR

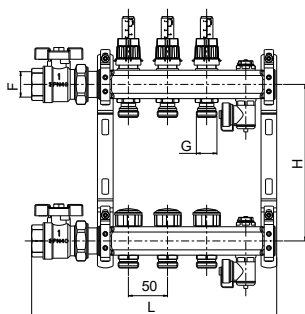

Collettore di mandata con misuratori di portata, valvola sfogo aria, rubinetto di carico/scarico acqua e valvola a sfera. Collettore di ritorno con valvole termostattizzabili, cappellotti di regolazione, valvola sfogo aria, rubinetto di carico/scarico acqua e valvola a sfera, tappi inclusi, con zanche di fissaggio

Inlet manifold with flow meters, air vent, fill & drain valve and ball valve. Return manifold with thermostatic valves, operating plastic caps, air vent, fill & drain valve and ball valve, plugs included, with mounting brackets

Vorlaufverteiler mit Durchflussmessern, Luftablassventil und Ein-/Ablassventil, Ein-/Ablassventil und Kugelhahn. Rücklaufverteiler mit thermostatisierbaren Ventilen, Einstellkappen, Luftablassventil und Ein-/Ablassventil und Kugelhahn - Stopfen inklusive, mit Befestigungsklammern

Collecteur d'alimentation avec mesureurs de débit, vanne de purge de l'air, robinet de chargement/déchargement et vanne à boisseau sphérique. Collecteur de retour avec vannes thermostatisables, chapeaux de réglage, vanne de purge de l'air, robinet de chargement/déchargement et vanne à boisseau sphérique, bouchons et plaques d'ancrage inclus

Входной коллектор с расходомерами, воздухоотводчиком, краном впуск-выпуск, шаровым краном. Обратный коллектор с термостатическими клапанами и регулируемыми колпачками, воздухоотводчиком, краном впуск-выпуск, шаровым краном. Комплектуется с заглушками для коллектора и кронштейнами.

| Cod./Code | (F) Misura/Size | (G) Attacco/Connection | Vie/Ways | L(mm) | H(mm) | □/田 | € |
|------------|-----------------|------------------------|----------|-------|-------|-----|--------|
| 1802A22502 | 1" | 3/4" EK | 2 | 263 | 200 | 1 | 131,76 |
| 1802A22503 | 1" | 3/4" EK | 3 | 313 | 200 | 1 | 156,06 |
| 1802A22504 | 1" | 3/4" EK | 4 | 363 | 200 | 1 | 180,58 |
| 1802A22505 | 1" | 3/4" EK | 5 | 413 | 200 | 1 | 204,63 |
| 1802A22506 | 1" | 3/4" EK | 6 | 463 | 200 | 1 | 228,69 |
| 1802A22507 | 1" | 3/4" EK | 7 | 513 | 200 | 1 | 253,21 |
| 1802A22508 | 1" | 3/4" EK | 8 | 563 | 200 | 1 | 277,60 |
| 1802A22509 | 1" | 3/4" EK | 9 | 613 | 200 | 1 | 298,75 |
| 1802A22510 | 1" | 3/4" EK | 10 | 663 | 200 | 1 | 323,85 |
| 1802A22511 | 1" | 3/4" EK | 11 | 713 | 200 | 1 | 347,67 |
| 1802A22512 | 1" | 3/4" EK | 12 | 763 | 200 | 1 | 371,41 |
| 1802A32506 | 1"1/4 | 3/4" EK | 6 | 486 | 200 | 1 | 285,42 |
| 1802A32507 | 1"1/4 | 3/4" EK | 7 | 536 | 200 | 1 | 312,08 |
| 1802A32508 | 1"1/4 | 3/4" EK | 8 | 586 | 200 | 1 | 338,35 |
| 1802A32509 | 1"1/4 | 3/4" EK | 9 | 636 | 200 | 1 | 365,55 |
| 1802A32510 | 1"1/4 | 3/4" EK | 10 | 686 | 200 | 1 | 392,21 |
| 1802A32511 | 1"1/4 | 3/4" EK | 11 | 736 | 200 | 1 | 418,41 |
| 1802A32512 | 1"1/4 | 3/4" EK | 12 | 768 | 200 | 1 | 444,69 |

KIT A 803 IVR

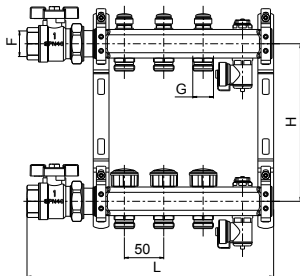

Collettore di mandata con detentori micrometrici, valvola sfogo aria, rubinetto di carico/scarico acqua, valvola a sfera. Collettore di ritorno con valvole termostattizzabili, cappellotti di regolazione, valvola sfogo aria, rubinetto di carico/scarico acqua e valvola a sfera, tappi inclusi, con zanche di fissaggio

Inlet manifold with micrometric lockshields, air vent and fill & drain valve, ball valve. Return manifold with thermostatic valves, operating plastic caps, air vent and fill & drain valve and ball valve, plugs included, with mounting brackets

Vorlaufverteiler mit mikrometrischen Rücklaufverschraubungen, Luftablassventil, Ein-/Ablassventil und Kugelhahn. Rücklaufverteiler mit thermostatisierbaren Ventilen, Einstellkappen, Luftablassventil, Ein-/Ablassventil und Kugelhahn - Stopfen inklusive, mit Befestigungsklammern

Collecteur d'alimentation avec détenteurs micrométriques, vanne de purge de l'air, robinet de chargement/déchargement, vanne à boisseau sphérique. Collecteur de retour avec vanne thermostatizable, chapeaux de réglage, vanne de purge de l'air, robinet de chargement/déchargement et vanne à boisseau sphérique, bouchons et plaques d'ancrage inclus

Входной коллектор с микрометрическими отсекающими вентилями, воздухоотводчиком, краном впуск-выпуск и шаровым краном. Обратный коллектор с терmostатическими клапанами и регулируемыми колпачками, воздухоотводчиком, краном впуск-выпуск, шаровым краном и заглушками. В комплекте с кронштейнами.

| Cod./Code | (F) Misura/Size | (G) Attacco/Connection | Vie/Ways | L(mm) | H(mm) | □/田 | € |
|------------|-----------------|------------------------|----------|-------|-------|-----|--------|
| 1803A22502 | 1" | 3/4" EK | 2 | 263 | 200 | 1 | 120,68 |
| 1803A22503 | 1" | 3/4" EK | 3 | 313 | 200 | 1 | 139,67 |
| 1803A22504 | 1" | 3/4" EK | 4 | 363 | 200 | 1 | 158,42 |
| 1803A22505 | 1" | 3/4" EK | 5 | 413 | 200 | 1 | 177,16 |
| 1803A22506 | 1" | 3/4" EK | 6 | 463 | 200 | 1 | 195,91 |
| 1803A22507 | 1" | 3/4" EK | 7 | 513 | 200 | 1 | 215,00 |
| 1803A22508 | 1" | 3/4" EK | 8 | 563 | 200 | 1 | 233,74 |
| 1803A22509 | 1" | 3/4" EK | 9 | 613 | 200 | 1 | 249,58 |
| 1803A22510 | 1" | 3/4" EK | 10 | 663 | 200 | 1 | 268,91 |
| 1803A22511 | 1" | 3/4" EK | 11 | 713 | 200 | 1 | 287,42 |
| 1803A22512 | 1" | 3/4" EK | 12 | 763 | 200 | 1 | 305,85 |
| 1803A32506 | 1"1/4 | 3/4" EK | 6 | 486 | 200 | 1 | 248,78 |
| 1803A32507 | 1"1/4 | 3/4" EK | 7 | 536 | 200 | 1 | 269,04 |
| 1803A32508 | 1"1/4 | 3/4" EK | 8 | 586 | 200 | 1 | 289,36 |
| 1803A32509 | 1"1/4 | 3/4" EK | 9 | 636 | 200 | 1 | 310,60 |
| 1803A32510 | 1"1/4 | 3/4" EK | 10 | 686 | 200 | 1 | 330,85 |
| 1803A32511 | 1"1/4 | 3/4" EK | 11 | 736 | 200 | 1 | 351,10 |
| 1803A32512 | 1"1/4 | 3/4" EK | 12 | 786 | 200 | 1 | 371,35 |

KIT A 814 IVR

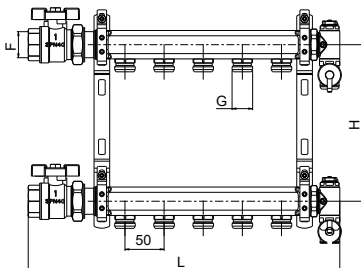

Collettore di mandata con valvola sfogo aria, rubinetto di carico/scarico acqua e valvola a sfera. Collettore di ritorno con valvola sfogo aria, rubinetto di carico/scarico acqua e valvola a sfera, tappi inclusi, con zanche di fissaggio

Inlet manifold with air vent, fill & drain valve and ball valve. Return manifold with air vent, fill & drain valve and ball valve, plugs included, with mounting brackets

Vorlaufverteiler mit Luftablassventil, Ein-/Ablassventil und Kugelhahn. Rücklaufverteiler mit Luftablassventil, Ein-/Ablassventil und Kugelhahn - Stopfen inklusive, mit Befestigungsklammern

Collecteur d'alimentation avec vanne de purge de l'air, robinet de chargement/déchargement et vanne à boisseau sphérique. Collecteur de retour avec vanne de purge de l'air, robinet de chargement/déchargement et vanne à boisseau sphérique, bouchons et plaques d'ancrage inclus

Входной коллектор с воздухоотводчиком, краном впуск-выпуск и шаровым краном. Обратный коллектор с воздухоотводчиком, краном впуск-выпуск, шаровым краном. Комплектуется с заглушками для коллектора и кронштейнами.

| Cod./Code | (F) Misura/Size | (G) Attacco/Connection | Vie/Ways | L(mm) | H(mm) | □/田 | € |
|------------|-----------------|------------------------|----------|-------|-------|-----|--------|
| 1814A22502 | 1" | 3/4" EK | 2 | 248 | 200 | 1 | 109,25 |
| 1814A22503 | 1" | 3/4" EK | 3 | 298 | 200 | 1 | 121,29 |
| 1814A22504 | 1" | 3/4" EK | 4 | 348 | 200 | 1 | 133,82 |
| 1814A22505 | 1" | 3/4" EK | 5 | 398 | 200 | 1 | 146,11 |
| 1814A22506 | 1" | 3/4" EK | 6 | 448 | 200 | 1 | 158,39 |
| 1814A22507 | 1" | 3/4" EK | 7 | 498 | 200 | 1 | 171,02 |
| 1814A22508 | 1" | 3/4" EK | 8 | 548 | 200 | 1 | 183,31 |
| 1814A22509 | 1" | 3/4" EK | 9 | 598 | 200 | 1 | 195,60 |
| 1814A22510 | 1" | 3/4" EK | 10 | 648 | 200 | 1 | 208,79 |
| 1814A22511 | 1" | 3/4" EK | 11 | 698 | 200 | 1 | 221,08 |
| 1814A22512 | 1" | 3/4" EK | 12 | 748 | 200 | 1 | 233,44 |
| 1814A32506 | 1"1/4 | 3/4" EK | 6 | 798 | 200 | 1 | 209,69 |
| 1814A32507 | 1"1/4 | 3/4" EK | 7 | 848 | 200 | 1 | 222,92 |
| 1814A32508 | 1"1/4 | 3/4" EK | 8 | 898 | 200 | 1 | 236,07 |
| 1814A32509 | 1"1/4 | 3/4" EK | 9 | 948 | 200 | 1 | 250,21 |
| 1814A32510 | 1"1/4 | 3/4" EK | 10 | 998 | 200 | 1 | 263,44 |
| 1814A32511 | 1"1/4 | 3/4" EK | 11 | 1048 | 200 | 1 | 276,59 |
| 1814A32512 | 1"1/4 | 3/4" EK | 12 | 1098 | 200 | 1 | 289,74 |

IVR 800

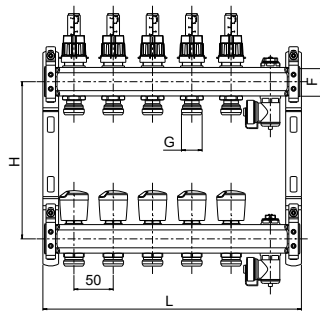

Collettore di mandata con misuratori di portata, valvola sfogo aria e rubinetto di carico/scarico acqua. Collettore di ritorno con valvole manuali con volantino, valvola sfogo aria e rubinetto di carico/scarico acqua, tappi e zanche di fissaggio incluse

Inlet manifold with flow meters, air vent and fill & drain valve. Return manifold with manual valves with handles, air vent and fill & drain valve, plugs and mounting brackets

Vorlaufverteiler mit Durchflussmessern, Entlüftungsventil und Füll- und Entleerungshahn. Rücklaufverteiler mit Ventilen mit Handrädern, Luftablassventil und Ein-/Ablassventil, komplett mit Kappen, mit Befestigungsklammern

Collecteur d'alimentation avec mesureurs de débits, vanne de purge de l'air et robinets de chargement/déchargement. Collecteur de retour avec vannes manuelles avec volant, vanne de purge de l'air et robinet de chargement/déchargement, bouchons et plaques d'ancrage inclus

Входной коллектор с расходомерами, воздухоотводчиком и краном впуск-выпуск. Обратный коллектор с ручными регулирующими клапанами, воздухоотводчиком, краном впуск-выпуск и заглушками. В комплекте с кронштейнами.

| Cod./Code | (F) Misura/Size | (G) Attacco/Connection | Vie/Ways | L(mm) | H(mm) | □/▣ | € |
|-----------|-----------------|------------------------|----------|-------|-------|-----|--------|
| 180022502 | 1" | 3/4" EK | 2 | 180 | 200 | 1 | 91,97 |
| 180022503 | 1" | 3/4" EK | 3 | 230 | 200 | 1 | 116,60 |
| 180022504 | 1" | 3/4" EK | 4 | 280 | 200 | 1 | 142,17 |
| 180022505 | 1" | 3/4" EK | 5 | 330 | 200 | 1 | 166,80 |
| 180022506 | 1" | 3/4" EK | 6 | 380 | 200 | 1 | 191,67 |
| 180022507 | 1" | 3/4" EK | 7 | 430 | 200 | 1 | 217,25 |
| 180022508 | 1" | 3/4" EK | 8 | 480 | 200 | 1 | 241,88 |
| 180022509 | 1" | 3/4" EK | 9 | 530 | 200 | 1 | 263,59 |
| 180022510 | 1" | 3/4" EK | 10 | 580 | 200 | 1 | 289,19 |
| 180022511 | 1" | 3/4" EK | 11 | 630 | 200 | 1 | 313,58 |
| 180022512 | 1" | 3/4" EK | 12 | 680 | 200 | 1 | 337,89 |
| 180032506 | 1"1/4 | 3/4" EK | 6 | 380 | 200 | 1 | 213,71 |
| 180032507 | 1"1/4 | 3/4" EK | 7 | 430 | 200 | 1 | 241,43 |
| 180032508 | 1"1/4 | 3/4" EK | 8 | 480 | 200 | 1 | 268,28 |
| 180032509 | 1"1/4 | 3/4" EK | 9 | 530 | 200 | 1 | 295,13 |
| 180032510 | 1"1/4 | 3/4" EK | 10 | 580 | 200 | 1 | 323,19 |
| 180032511 | 1"1/4 | 3/4" EK | 11 | 630 | 200 | 1 | 349,97 |
| 180032512 | 1"1/4 | 3/4" EK | 12 | 680 | 200 | 1 | 376,82 |

IVR 801

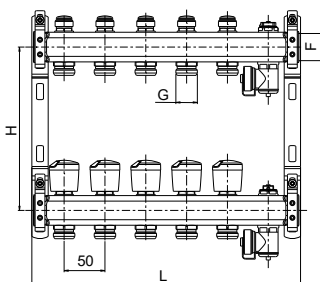

Collettore di mandata con detentori micrometrici, valvola sfogo aria e rubinetto di carico/scarico acqua. Collettore di ritorno con valvole manuali con volantino, valvola sfogo aria e rubinetto di carico/scarico acqua, tappi e zanche di fissaggio incluse

Inlet manifold with micrometric lockshields, air vent and fill & drain valve. Return manifold with manual valves with handles, air vent and fill & drain valve, plugs and mounting brackets

Vorlaufverteiler mit mikrometrischen Rücklaufverschraubungen, Luftablassventil und Ein-/Ablassventil. Rücklaufverteiler mit Ventilen mit Handrädern, Luftablassventil und Ein-/Ablassventil, komplett mit Kappen und Befestigungsklammern

Collecteur d'alimentation avec coude de réglage micrométriques, vanne de purge de l'air et robinet de chargement/déchargement. Collecteur de retour avec vannes manuelles avec volant, vanne de purge de l'air et robinet de chargement/déchargement, bouchons et plaques d'ancrage inclus

Входной коллектор с микрометрическими отсекающими вентилями, воздухоотводчиком и краном впуск-выпуск. Обратный коллектор с ручными регулирующими клапанами, воздухоотводчиком, краном впуск-выпуск и заглушками. В комплекте с кронштейнами.

| Cod./Code | (F) Misura/Size | (G) Attacco/Connection | Vie/Ways | L(mm) | H(mm) | □/▣ | € |
|-----------|-----------------|------------------------|----------|-------|-------|-----|--------|
| 180122502 | 1" | 3/4" EK | 2 | 180 | 200 | 1 | 80,89 |
| 180122503 | 1" | 3/4" EK | 3 | 230 | 200 | 1 | 100,21 |
| 180122504 | 1" | 3/4" EK | 4 | 280 | 200 | 1 | 120,01 |
| 180122505 | 1" | 3/4" EK | 5 | 330 | 200 | 1 | 139,33 |
| 180122506 | 1" | 3/4" EK | 6 | 380 | 200 | 1 | 158,89 |
| 180122507 | 1" | 3/4" EK | 7 | 430 | 200 | 1 | 178,70 |
| 180122508 | 1" | 3/4" EK | 8 | 480 | 200 | 1 | 198,01 |
| 180122509 | 1" | 3/4" EK | 9 | 530 | 200 | 1 | 214,42 |
| 180122510 | 1" | 3/4" EK | 10 | 580 | 200 | 1 | 234,25 |
| 180122511 | 1" | 3/4" EK | 11 | 630 | 200 | 1 | 253,33 |
| 180122512 | 1" | 3/4" EK | 12 | 680 | 200 | 1 | 272,33 |
| 180132506 | 1"1/4 | 3/4" EK | 6 | 380 | 200 | 1 | 177,08 |
| 180132507 | 1"1/4 | 3/4" EK | 7 | 430 | 200 | 1 | 198,39 |
| 180132508 | 1"1/4 | 3/4" EK | 8 | 480 | 200 | 1 | 219,28 |
| 180132509 | 1"1/4 | 3/4" EK | 9 | 530 | 200 | 1 | 240,18 |
| 180132510 | 1"1/4 | 3/4" EK | 10 | 580 | 200 | 1 | 261,83 |
| 180132511 | 1"1/4 | 3/4" EK | 11 | 630 | 200 | 1 | 282,65 |
| 180132512 | 1"1/4 | 3/4" EK | 12 | 680 | 200 | 1 | 303,55 |

IVR 802

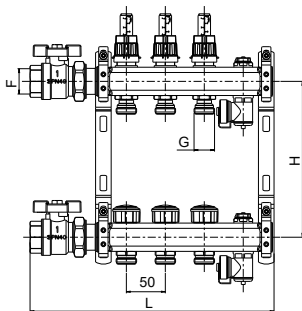

Collettore di mandata con misuratori di portata, valvola di sfogo aria e rubinetto di scarico/carico acqua. Collettore di ritorno con valvole termostattizzabili con cappellotti di regolazione, valvola sfogo aria e rubinetto di carico/scarico, tappi e zanche di fissaggio incluse

Inlet manifold with flow meters, air vent and fill & drain valve. Return manifold with thermostatic valves with operating plastic caps, air vent and fill & drain valve, plugs and mounting brackets

Vorlaufverteiler mit Durchflussmessern, Luftablassventil und Ein-/Ablassventil. Rücklaufverteiler mit thermostatisierbaren Ventilen mit Einstellkappen, Luftablassventil und Ein-/Ablassventil, komplett mit Kappen und Befestigungsklammern

Collecteur d'alimentation avec mesureurs de débit, vanne de purge de l'air et robinet de chargement/déchargement. Collecteur de retour avec vannes thermostatisables avec chapeaux de réglage, vanne de purge de l'air et robinet de chargement/déchargement, bouchons et plaques d'ancrage inclus

Входной коллектор с расходомерами, воздухоотводчиком и краном впуск-выпуск. Обратный коллектор с термостатическими клапанами и регулируемыми колпачками, воздухоотводчиком, краном впуск-выпуск и заглушками. В комплекте с кронштейнами.

| Cod./Code | (F) Misura/Size | (G) Attacco/Connection | Vie/Ways | L(mm) | H(mm) | □/田 | € |
|-----------|-----------------|------------------------|----------|-------|-------|-----|--------|
| 180222502 | 1" | 3/4" EK | 2 | 180 | 200 | 1 | 90,35 |
| 180222503 | 1" | 3/4" EK | 3 | 230 | 200 | 1 | 114,40 |
| 180222504 | 1" | 3/4" EK | 4 | 280 | 200 | 1 | 138,92 |
| 180222505 | 1" | 3/4" EK | 5 | 330 | 200 | 1 | 162,98 |
| 180222506 | 1" | 3/4" EK | 6 | 380 | 200 | 1 | 187,28 |
| 180222507 | 1" | 3/4" EK | 7 | 430 | 200 | 1 | 211,80 |
| 180222508 | 1" | 3/4" EK | 8 | 480 | 200 | 1 | 235,85 |
| 180222509 | 1" | 3/4" EK | 9 | 530 | 200 | 1 | 257,00 |
| 180222510 | 1" | 3/4" EK | 10 | 580 | 200 | 1 | 281,54 |
| 180222511 | 1" | 3/4" EK | 11 | 630 | 200 | 1 | 305,36 |
| 180222512 | 1" | 3/4" EK | 12 | 680 | 200 | 1 | 329,10 |
| 180232506 | 1"1/4 | 3/4" EK | 6 | 380 | 200 | 1 | 209,31 |
| 180232507 | 1"1/4 | 3/4" EK | 7 | 430 | 200 | 1 | 235,98 |
| 180232508 | 1"1/4 | 3/4" EK | 8 | 480 | 200 | 1 | 262,26 |
| 180232509 | 1"1/4 | 3/4" EK | 9 | 530 | 200 | 1 | 288,54 |
| 180232510 | 1"1/4 | 3/4" EK | 10 | 580 | 200 | 1 | 315,54 |
| 180232511 | 1"1/4 | 3/4" EK | 11 | 630 | 200 | 1 | 341,74 |
| 180232512 | 1"1/4 | 3/4" EK | 12 | 680 | 200 | 1 | 368,02 |

IVR 803

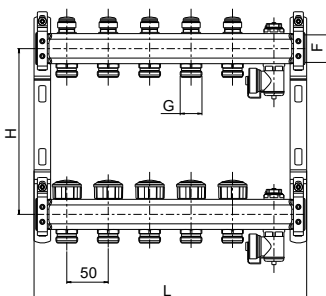

Collettore di mandata con detentori micrometrici, valvola sfogo aria e rubinetto di carico/scarico acqua. Collettore di ritorno con valvole termostattizzabili con cappellotti di regolazione, valvola sfogo aria e rubinetto di carico/scarico acqua, tappi e zanche di fissaggio incluse

Inlet manifold with micrometric lockshields, air vent and fill & drain valve. Return manifold with thermostatic valves with operating plastic caps, air vent and fill & drain valve, plugs and mounting brackets included

Vorlaufverteiler mit mikrometrischen Rücklaufverschraubungen, Luftablassventil und Ein-/Ablassventil. Rücklaufverteiler mit thermostatisierbaren Ventilen mit Einstellkappen, Luftablassventil und Ein-/Ablassventil, komplett mit Kappen und Befestigungsklammern

Collecteur d'alimentation avec coude de réglage micrométriques, vanne de purge de l'air et robinet de chargement/déchargement. Collecteur de retour avec vannes thermostatisables avec chapeaux de réglage, vanne de purge de l'air et robinet de chargement/déchargement, caps enthalten, bouchons et plaques d'ancrage inclus

Входной коллектор с микрометрическими отсекающими вентилями, воздухоотводчиком и краном впуск-выпуск. Обратный коллектор с термостатическими клапанами и регулируемыми колпачками, воздухоотводчиком, краном впуск-выпуск и заглушками. В комплекте с кронштейнами.

| Cod./Code | (F) Misura/Size | (G) Attacco/Connection | Vie/Ways | L(mm) | H(mm) | □/田 | € |
|-----------|-----------------|------------------------|----------|-------|-------|-----|--------|
| 180322502 | 1" | 3/4" EK | 2 | 180 | 200 | 1 | 79,27 |
| 180322503 | 1" | 3/4" EK | 3 | 230 | 200 | 1 | 98,01 |
| 180322504 | 1" | 3/4" EK | 4 | 280 | 200 | 1 | 116,76 |
| 180322505 | 1" | 3/4" EK | 5 | 330 | 200 | 1 | 135,51 |
| 180322506 | 1" | 3/4" EK | 6 | 380 | 200 | 1 | 154,50 |
| 180322507 | 1" | 3/4" EK | 7 | 430 | 200 | 1 | 173,25 |
| 180322508 | 1" | 3/4" EK | 8 | 480 | 200 | 1 | 191,99 |
| 180322509 | 1" | 3/4" EK | 9 | 530 | 200 | 1 | 207,83 |
| 180322510 | 1" | 3/4" EK | 10 | 580 | 200 | 1 | 226,60 |
| 180322511 | 1" | 3/4" EK | 11 | 630 | 200 | 1 | 245,11 |
| 180322512 | 1" | 3/4" EK | 12 | 680 | 200 | 1 | 263,54 |
| 180332506 | 1"1/4 | 3/4" EK | 6 | 380 | 200 | 1 | 172,68 |
| 180332507 | 1"1/4 | 3/4" EK | 7 | 430 | 200 | 1 | 192,93 |
| 180332508 | 1"1/4 | 3/4" EK | 8 | 480 | 200 | 1 | 213,26 |
| 180332509 | 1"1/4 | 3/4" EK | 9 | 530 | 200 | 1 | 233,59 |
| 180332510 | 1"1/4 | 3/4" EK | 10 | 580 | 200 | 1 | 254,18 |
| 180332511 | 1"1/4 | 3/4" EK | 11 | 630 | 200 | 1 | 274,43 |
| 180332512 | 1"1/4 | 3/4" EK | 12 | 680 | 200 | 1 | 294,76 |

IVR 804

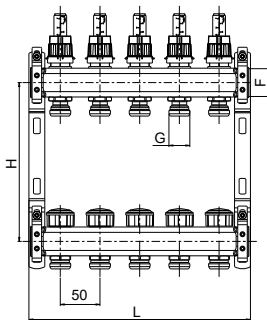

Collettore di mandata con misuratori di portata; collettore di ritorno con valvole termostattizzabili con cappellotti di regolazione, tappi e zanche di fissaggio incluse

Inlet manifold with flow meters; return manifold with thermostatic valves with operating plastic caps, plugs and mounting brackets included

Vorlaufverteiler mit Durchflussmessern; Rücklaufverteiler mit thermostatisierbaren Ventilen mit Einstellkappen, komplett mit Kappen und Befestigungsklammern

Collecteur d'alimentation avec méseurs de débit; collecteur de retour avec vannes thermostatissables avec chapeaux de réglage, bouchons et plaques d'ancrage inclus

Входной коллектор с расходомерами; Обратный коллектор с термостатическими клапанами и регулируемыми колпачками. Комплектуется с заглушками для коллектора и кронштейнами.

| Cod./Code | (F) Misura/Size | (G) Attacco/Connection | Vie/Ways | L(mm) | H(mm) | □/田 | € |
|-----------|-----------------|------------------------|----------|-------|-------|-----|--------|
| 180422502 | 1" | 3/4" EK | 2 | 130 | 200 | 1 | 70,14 |
| 180422503 | 1" | 3/4" EK | 3 | 180 | 200 | 1 | 94,19 |
| 180422504 | 1" | 3/4" EK | 4 | 230 | 200 | 1 | 118,71 |
| 180422505 | 1" | 3/4" EK | 5 | 280 | 200 | 1 | 142,77 |
| 180422506 | 1" | 3/4" EK | 6 | 330 | 200 | 1 | 167,07 |
| 180422507 | 1" | 3/4" EK | 7 | 380 | 200 | 1 | 191,59 |
| 180422508 | 1" | 3/4" EK | 8 | 430 | 200 | 1 | 215,64 |
| 180422509 | 1" | 3/4" EK | 9 | 480 | 200 | 1 | 239,70 |
| 180422510 | 1" | 3/4" EK | 10 | 530 | 200 | 1 | 261,64 |
| 180422511 | 1" | 3/4" EK | 11 | 580 | 200 | 1 | 285,39 |
| 180422512 | 1" | 3/4" EK | 12 | 630 | 200 | 1 | 309,20 |
| 180422513 | 1" | 3/4" EK | 13 | 680 | 200 | 1 | 333,41 |
| 180432506 | 1"1/4 | 3/4" EK | 6 | 330 | 200 | 1 | 188,16 |
| 180432507 | 1"1/4 | 3/4" EK | 7 | 380 | 200 | 1 | 214,90 |
| 180432508 | 1"1/4 | 3/4" EK | 8 | 430 | 200 | 1 | 241,10 |
| 180432509 | 1"1/4 | 3/4" EK | 9 | 480 | 200 | 1 | 267,38 |
| 180432510 | 1"1/4 | 3/4" EK | 10 | 530 | 200 | 1 | 294,46 |
| 180432511 | 1"1/4 | 3/4" EK | 11 | 580 | 200 | 1 | 320,67 |
| 180432512 | 1"1/4 | 3/4" EK | 12 | 630 | 200 | 1 | 346,87 |
| 180432513 | 1"1/4 | 3/4" EK | 13 | 680 | 200 | 1 | 373,06 |

IVR 804/R

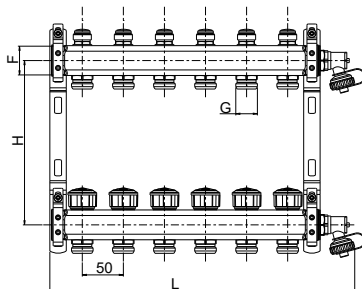

Collettore di mandata con misuratori di portata e rubinetto di carico/scarico acqua; collettore di ritorno con valvola termostattizzabili con cappellotto di regolazione e rubinetto di carico/scarico acqua, tappi e zanche di fissaggio incluse

Inlet manifold with flow meters and fill & drain valve; outlet manifold with thermostatic valves with operating plastic cap and fill & drain valve, plugs and mounting brackets included

Vorlaufverteiler mit Durchflussmeter und ein-/Ablassventil; Rücklaufverteiler mit thermostatisierbaren Ventilen mit Einstellkappe und Ein-/Ablassventil, komplett mit Kappen und Befestigungsklammern

Collecteur d'alimentation avec mesureur de débit et robinet de chargement/déchargement; collecteur de retour avec vannes thermostatissables avec chapeau de réglage e robinet de chargement/déchargement, bouchons et plaques d'ancrage inclus

Входной коллектор с расходомерами и краном впуск-выпуск; Обратный коллектор с термостатическими клапанами и регулируемыми колпачками, кран впуск-выпуск

| Cod./Code | (F) Misura/Size | (G) Attacco/Connection | Vie/Ways | L(mm) | H(mm) | □/田 | € |
|------------|-----------------|------------------------|----------|-------|-------|-----|--------|
| 1804R22502 | 1" | 3/4" EK | 2 | 171 | 200 | 1 | 80,94 |
| 1804R22503 | 1" | 3/4" EK | 3 | 221 | 200 | 1 | 105,00 |
| 1804R22504 | 1" | 3/4" EK | 4 | 271 | 200 | 1 | 129,51 |
| 1804R22505 | 1" | 3/4" EK | 5 | 321 | 200 | 1 | 153,57 |
| 1804R22506 | 1" | 3/4" EK | 6 | 371 | 200 | 1 | 177,87 |
| 1804R22507 | 1" | 3/4" EK | 7 | 421 | 200 | 1 | 202,39 |
| 1804R22508 | 1" | 3/4" EK | 8 | 471 | 200 | 1 | 226,44 |
| 1804R22509 | 1" | 3/4" EK | 9 | 521 | 200 | 1 | 250,50 |
| 1804R22510 | 1" | 3/4" EK | 10 | 571 | 200 | 1 | 272,45 |
| 1804R22511 | 1" | 3/4" EK | 11 | 621 | 200 | 1 | 296,19 |
| 1804R22512 | 1" | 3/4" EK | 12 | 671 | 200 | 1 | 320,01 |
| 1804R22513 | 1" | 3/4" EK | 13 | 721 | 200 | 1 | 344,22 |

IVR 805

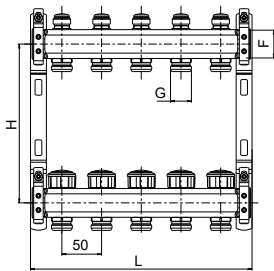

Collettore di mandata con detentori micrometrici; collettore di ritorno con valvole termostattizzabili con cappellotti di regolazione, tappi e zanche di fissaggio incluse

Inlet manifold with micrometric lockshields; return manifold with thermostatic valves with operating plastic caps, plugs and mounting brackets included

Vorlaufverteiler mit mikrometrischen Rücklaufverschraubungen; Rücklaufverteiler mit thermostatisierbaren Ventilen mit Einstellkappen, komplett mit Kappen und Befestigungsklammern

Collecteur d'alimentation avec coude de réglage micrométriques; collecteur de retour avec vannes thermostatisables avec chapeaux de réglage, bouchons et plaques d'ancrage inclus

Входной коллектор с микрометрическими отсекающими вентилями. Обратный коллектор с термостатическими клапанами и регулируемыми колпачками. Комплектуется с заглушками для коллектора и кронштейнами.

| Cod./Code | (F) Misura/Size | (G) Attacco/Connection | Vie/Ways | L(mm) | H(mm) | □/田 | € |
|-----------|-----------------|------------------------|----------|-------|-------|-----|--------|
| 180522502 | 1" | 3/4" EK | 2 | 130 | 200 | 1 | 59,06 |
| 180522503 | 1" | 3/4" EK | 3 | 180 | 200 | 1 | 77,80 |
| 180522504 | 1" | 3/4" EK | 4 | 230 | 200 | 1 | 96,55 |
| 180522505 | 1" | 3/4" EK | 5 | 280 | 200 | 1 | 115,30 |
| 180522506 | 1" | 3/4" EK | 6 | 330 | 200 | 1 | 134,04 |
| 180522507 | 1" | 3/4" EK | 7 | 380 | 200 | 1 | 153,04 |
| 180522508 | 1" | 3/4" EK | 8 | 430 | 200 | 1 | 171,78 |
| 180522509 | 1" | 3/4" EK | 9 | 480 | 200 | 1 | 190,53 |
| 180522510 | 1" | 3/4" EK | 10 | 530 | 200 | 1 | 206,70 |
| 180522511 | 1" | 3/4" EK | 11 | 580 | 200 | 1 | 225,14 |
| 180522512 | 1" | 3/4" EK | 12 | 630 | 200 | 1 | 243,64 |
| 180522513 | 1" | 3/4" EK | 13 | 680 | 200 | 1 | 262,07 |
| 180532506 | 1 1/4" | 3/4" EK | 6 | 330 | 200 | 1 | 151,53 |
| 180532507 | 1 1/4" | 3/4" EK | 7 | 380 | 200 | 1 | 171,86 |
| 180532508 | 1 1/4" | 3/4" EK | 8 | 430 | 200 | 1 | 192,10 |
| 180532509 | 1 1/4" | 3/4" EK | 9 | 480 | 200 | 1 | 212,43 |
| 180532510 | 1 1/4" | 3/4" EK | 10 | 530 | 200 | 1 | 233,10 |
| 180532511 | 1 1/4" | 3/4" EK | 11 | 580 | 200 | 1 | 253,35 |
| 180532512 | 1 1/4" | 3/4" EK | 12 | 630 | 200 | 1 | 273,60 |
| 180532513 | 1 1/4" | 3/4" EK | 13 | 680 | 200 | 1 | 293,93 |

IVR 805/R

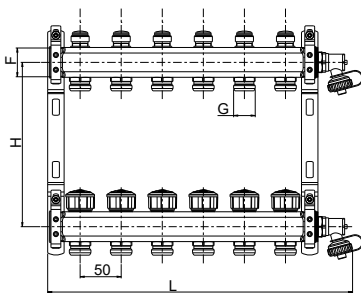

Collettore di mandata con detentori micrometrici e rubinetto di carico/scarico acqua; collettore di ritorno con valvole termostattizzabili con cappello di regolazione e rubinetto di carico/scarico acqua, tappi e zanche di fissaggio incluse

Inlet manifold with micrometric lockshields and fill & drain valve; outlet manifold with thermostatic valves with operating plastic cap and fill & drain valve, plugs and mounting brackets included

Vorlaufverteiler mit mikrometrischen Rücklaufverschraubungen und Ein-/Ablassventil; Rücklaufverteiler mit thermostatisierbaren Ventilen mit Einstellkappe und Ein-/Ablassventil, komplett mit Kappen und Befestigungsklammern

Collecteur d'alimentation avec coude de réglage micrométrique et robinet de chargement/déchargement; collecteur de retour avec vannes thermostatisables avec chapeau de réglage et robinet de chargement/déchargement, bouchons et plaques d'ancrage inclus

Входной коллектор с микрометрическими отсекающими вентилями и краном впуск-выпуск; Обратный коллектор с термостатическими клапанами и регулирующим колпачком, кран впуск-выпуск. Комплектуется с заглушками для коллектора и кронштейнами.

| Cod./Code | (F) Misura/Size | (G) Attacco/Connection | Vie/Ways | L(mm) | H(mm) | □/田 | € |
|------------|-----------------|------------------------|----------|-------|-------|-----|--------|
| 1805R22502 | 1" | 3/4" EK | 2 | 171 | 200 | 1 | 69,86 |
| 1805R22503 | 1" | 3/4" EK | 3 | 221 | 200 | 1 | 88,61 |
| 1805R22504 | 1" | 3/4" EK | 4 | 271 | 200 | 1 | 107,35 |
| 1805R22505 | 1" | 3/4" EK | 5 | 321 | 200 | 1 | 126,10 |
| 1805R22506 | 1" | 3/4" EK | 6 | 371 | 200 | 1 | 144,84 |
| 1805R22507 | 1" | 3/4" EK | 7 | 421 | 200 | 1 | 163,84 |
| 1805R22508 | 1" | 3/4" EK | 8 | 471 | 200 | 1 | 182,58 |
| 1805R22509 | 1" | 3/4" EK | 9 | 521 | 200 | 1 | 201,33 |
| 1805R22510 | 1" | 3/4" EK | 10 | 571 | 200 | 1 | 217,51 |
| 1805R22511 | 1" | 3/4" EK | 11 | 621 | 200 | 1 | 235,94 |
| 1805R22512 | 1" | 3/4" EK | 12 | 671 | 200 | 1 | 254,45 |
| 1805R22513 | 1" | 3/4" EK | 13 | 721 | 200 | 1 | 272,88 |

IVR 806

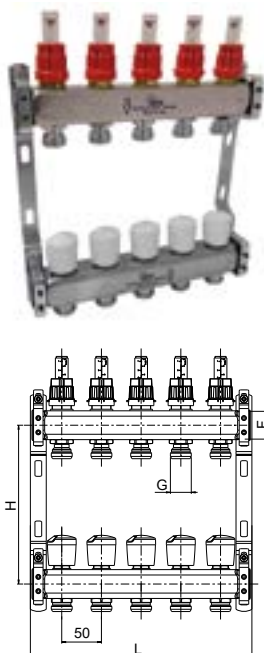

Collettore di mandata con misuratori di portata. Collettore di ritorno con valvole manuali con volantini, tappi e zanche di fissaggio incluse

Inlet manifold with flow meters. Return manifold with manual valves with handles, plugs and mounting brackets included

Vorlaufverteiler mit Durchflussmessern. Rücklaufverteiler mit Ventilen mit Handrädern, komplett mit Kappen und Befestigungsklammern

Collecteur d'alimentation avec mesureurs de débit. Collecteur de retour avec vannes manuelles avec volantins, bouchons et plaques d'ancrage inclus

Входной коллектор с расходомерами. Обратный коллектор с ручными регулируемыми клапанами и заглушками. В комплекте с кронштейнами.

| Cod./Code | (F) Misura/Size | (G) Attacco/Connection | Vie/Ways | L(mm) | H(mm) | □/田 | € |
|-----------|-----------------|------------------------|----------|-------|-------|-----|--------|
| 180622502 | 1" | 3/4" EK | 2 | 130 | 200 | 1 | 71,76 |
| 180622503 | 1" | 3/4" EK | 3 | 180 | 200 | 1 | 96,39 |
| 180622504 | 1" | 3/4" EK | 4 | 230 | 200 | 1 | 121,96 |
| 180622505 | 1" | 3/4" EK | 5 | 280 | 200 | 1 | 146,59 |
| 180622506 | 1" | 3/4" EK | 6 | 330 | 200 | 1 | 171,46 |
| 180622507 | 1" | 3/4" EK | 7 | 380 | 200 | 1 | 197,04 |
| 180622508 | 1" | 3/4" EK | 8 | 430 | 200 | 1 | 221,66 |
| 180622509 | 1" | 3/4" EK | 9 | 480 | 200 | 1 | 246,29 |
| 180622510 | 1" | 3/4" EK | 10 | 530 | 200 | 1 | 269,30 |
| 180622511 | 1" | 3/4" EK | 11 | 580 | 200 | 1 | 293,61 |
| 180622512 | 1" | 3/4" EK | 12 | 630 | 200 | 1 | 318,00 |
| 180622513 | 1" | 3/4" EK | 13 | 680 | 200 | 1 | 340,16 |
| | | | | | | | |
| 180632506 | 1"1/4 | 3/4" EK | 6 | 330 | 200 | 1 | 192,56 |
| 180632507 | 1"1/4 | 3/4" EK | 7 | 380 | 200 | 1 | 220,07 |
| 180632508 | 1"1/4 | 3/4" EK | 8 | 430 | 200 | 1 | 247,13 |
| 180632509 | 1"1/4 | 3/4" EK | 9 | 480 | 200 | 1 | 273,98 |
| 180632510 | 1"1/4 | 3/4" EK | 10 | 530 | 200 | 1 | 302,12 |
| 180632511 | 1"1/4 | 3/4" EK | 11 | 580 | 200 | 1 | 328,44 |
| 180632512 | 1"1/4 | 3/4" EK | 12 | 630 | 200 | 1 | 355,66 |
| 180632513 | 1"1/4 | 3/4" EK | 13 | 680 | 200 | 1 | 380,36 |

IVR 807

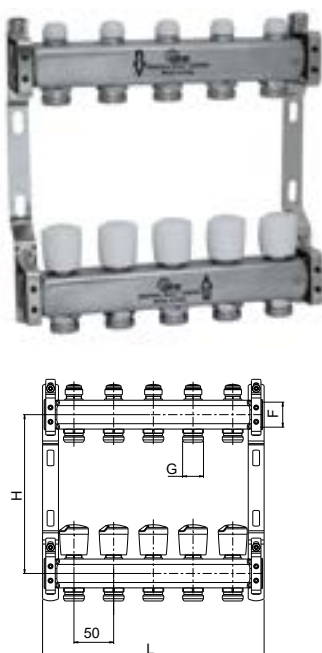

Collettore di mandata con detentori micrometrici. Collettore di ritorno con valvole manuali con volantini, tappi e zanche di fissaggio incluse

Inlet manifold with micrometric lockshields. Return manifold with manual valves with handles, plugs and mounting brackets included

Vorlaufverteiler mit mikrometrischen Rücklaufverschraubungen. Rücklaufverteiler mit Ventilen mit Handrädern, komplett mit Kappen und Befestigungsklammern

Collecteur d'alimentation avec coude de réglage micrométriques. Collecteur de retour avec vannes manuelles avec volantins, bouchons et plaques d'ancrage inclus

Входной коллектор с микрометрическими отсекающими вентилями. Обратный коллектор с ручными регулируемыми клапанами и заглушками. В комплекте с кронштейнами.

| Cod./Code | (F) Misura/Size | (G) Attacco/Connection | Vie/Ways | L(mm) | H(mm) | □/田 | € |
|-----------|-----------------|------------------------|----------|-------|-------|-----|--------|
| 180722502 | 1" | 3/4" EK | 2 | 130 | 200 | 1 | 60,68 |
| 180722503 | 1" | 3/4" EK | 3 | 180 | 200 | 1 | 80,00 |
| 180722504 | 1" | 3/4" EK | 4 | 230 | 200 | 1 | 99,80 |
| 180722505 | 1" | 3/4" EK | 5 | 280 | 200 | 1 | 119,12 |
| 180722506 | 1" | 3/4" EK | 6 | 330 | 200 | 1 | 138,56 |
| 180722507 | 1" | 3/4" EK | 7 | 380 | 200 | 1 | 158,49 |
| 180722508 | 1" | 3/4" EK | 8 | 430 | 200 | 1 | 177,80 |
| 180722509 | 1" | 3/4" EK | 9 | 480 | 200 | 1 | 197,12 |
| 180722510 | 1" | 3/4" EK | 10 | 530 | 200 | 1 | 214,36 |
| 180722511 | 1" | 3/4" EK | 11 | 580 | 200 | 1 | 233,36 |
| 180722512 | 1" | 3/4" EK | 12 | 630 | 200 | 1 | 252,44 |
| 180722513 | 1" | 3/4" EK | 13 | 680 | 200 | 1 | 271,93 |
| | | | | | | | |
| 180732506 | 1"1/4 | 3/4" EK | 6 | 330 | 200 | 1 | 155,80 |
| 180732507 | 1"1/4 | 3/4" EK | 7 | 380 | 200 | 1 | 177,31 |
| 180732508 | 1"1/4 | 3/4" EK | 8 | 430 | 200 | 1 | 198,39 |
| 180732509 | 1"1/4 | 3/4" EK | 9 | 480 | 200 | 1 | 219,03 |
| 180732510 | 1"1/4 | 3/4" EK | 10 | 530 | 200 | 1 | 240,76 |
| 180732511 | 1"1/4 | 3/4" EK | 11 | 580 | 200 | 1 | 261,58 |
| 180732512 | 1"1/4 | 3/4" EK | 12 | 630 | 200 | 1 | 282,40 |
| 180732513 | 1"1/4 | 3/4" EK | 13 | 680 | 200 | 1 | 303,26 |

IVR 813

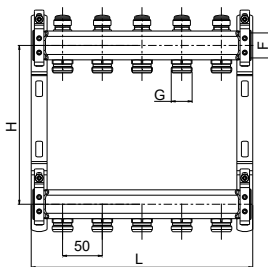

Collettore di mandata con detentori micrometrici. Collettore di ritorno con raccordi 3/4" Eurokonus, tappi e zanche di fissaggio incluse

Inlet manifold with micrometric lockshields. Return manifold with 3/4" Eurocone connections, plugs and mounting brackets included

Vorlaufverteiler mit mikrometrischen Rücklaufverschraubungen. Rücklaufverteiler mit 3/4" EK Verbindungsstücken, komplett mit Kappen und Befestigungsklammern

Collecteur d'alimentation avec coude de réglage micrométriques. Collecteur de retour avec sorties 3/4" EK, bouchons et plaques d'ancrage inclus

Входной коллектор с микрометрическими отсекающими вентилями. Обратный коллектор. Комплектуется с заглушками для коллектора и кронштейнами.

| Cod./Code | (F) Misura/Size | (G) Attacco/Connection | Vie/Ways | L(mm) | H(mm) | □/田 | € |
|-----------|-----------------|------------------------|----------|-------|-------|-----|--------|
| 181322502 | 1" | 3/4" EK | 2 | 130 | 200 | 1 | 51,00 |
| 181322503 | 1" | 3/4" EK | 3 | 180 | 200 | 1 | 65,72 |
| 181322504 | 1" | 3/4" EK | 4 | 230 | 200 | 1 | 80,44 |
| 181322505 | 1" | 3/4" EK | 5 | 280 | 200 | 1 | 95,16 |
| 181322506 | 1" | 3/4" EK | 6 | 330 | 200 | 1 | 110,12 |
| 181322507 | 1" | 3/4" EK | 7 | 380 | 200 | 1 | 124,84 |
| 181322508 | 1" | 3/4" EK | 8 | 430 | 200 | 1 | 139,56 |
| 181322509 | 1" | 3/4" EK | 9 | 480 | 200 | 1 | 154,28 |
| 181322510 | 1" | 3/4" EK | 10 | 530 | 200 | 1 | 167,88 |
| 181322511 | 1" | 3/4" EK | 11 | 580 | 200 | 1 | 182,44 |
| 181322512 | 1" | 3/4" EK | 12 | 630 | 200 | 1 | 197,08 |
| 181322513 | 1" | 3/4" EK | 13 | 680 | 200 | 1 | 211,60 |
| | | | | | | | |
| 181332506 | 1"1/4 | 3/4" EK | 6 | 330 | 200 | 1 | 125,44 |
| 181332507 | 1"1/4 | 3/4" EK | 7 | 380 | 200 | 1 | 141,43 |
| 181332508 | 1"1/4 | 3/4" EK | 8 | 430 | 200 | 1 | 157,33 |
| 181332509 | 1"1/4 | 3/4" EK | 9 | 480 | 200 | 1 | 173,31 |
| 181332510 | 1"1/4 | 3/4" EK | 10 | 530 | 200 | 1 | 189,63 |
| 181332511 | 1"1/4 | 3/4" EK | 11 | 580 | 200 | 1 | 205,54 |
| 181332512 | 1"1/4 | 3/4" EK | 12 | 630 | 200 | 1 | 221,44 |
| 181332513 | 1"1/4 | 3/4" EK | 13 | 680 | 200 | 1 | 237,42 |

IVR 814

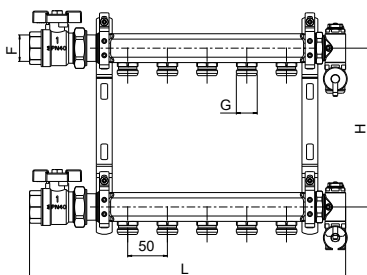

Collettore di mandata con collettore di ritorno con raccordi 3/4" Eurokonus, tappi e zanche di fissaggio incluse

Inlet manifold with return manifold with 3/4" Eurocone connections, plugs and mounting brackets included

Vorlaufverteiler mit Rücklaufverteiler mit 3/4" EK Verbindungsstücken, komplett mit Kappen und Befestigungsklammern

Collecteur d'alimentation avec collecteur de retour avec sorties 3/4" EK, bouchons et plaques d'ancrage inclus

Входной коллектор с обратным коллектором. Комплектуется с заглушками для коллектора и кронштейнами.

| Cod./Code | (F) Misura/Size | (G) Attacco/Connection | Vie/Ways | L(mm) | H(mm) | □/田 | € |
|-----------|-----------------|------------------------|----------|-------|-------|-----|--------|
| 181422502 | 1" | 3/4" EK | 2 | 130 | 200 | 1 | 46,14 |
| 181422503 | 1" | 3/4" EK | 3 | 180 | 200 | 1 | 58,42 |
| 181422504 | 1" | 3/4" EK | 4 | 230 | 200 | 1 | 70,71 |
| 181422505 | 1" | 3/4" EK | 5 | 280 | 200 | 1 | 83,00 |
| 181422506 | 1" | 3/4" EK | 6 | 330 | 200 | 1 | 95,28 |
| 181422507 | 1" | 3/4" EK | 7 | 380 | 200 | 1 | 107,82 |
| 181422508 | 1" | 3/4" EK | 8 | 430 | 200 | 1 | 120,10 |
| 181422509 | 1" | 3/4" EK | 9 | 480 | 200 | 1 | 132,39 |
| 181422510 | 1" | 3/4" EK | 10 | 530 | 200 | 1 | 145,02 |
| 181422511 | 1" | 3/4" EK | 11 | 580 | 200 | 1 | 157,31 |
| 181422512 | 1" | 3/4" EK | 12 | 630 | 200 | 1 | 169,67 |
| 181422513 | 1" | 3/4" EK | 13 | 680 | 200 | 1 | 181,88 |
| | | | | | | | |
| 181432506 | 1"1/4 | 3/4" EK | 6 | 330 | 200 | 1 | 108,94 |
| 181432507 | 1"1/4 | 3/4" EK | 7 | 380 | 200 | 1 | 122,17 |
| 181432508 | 1"1/4 | 3/4" EK | 8 | 430 | 200 | 1 | 135,32 |
| 181432509 | 1"1/4 | 3/4" EK | 9 | 480 | 200 | 1 | 148,55 |
| 181432510 | 1"1/4 | 3/4" EK | 10 | 530 | 200 | 1 | 162,13 |
| 181432511 | 1"1/4 | 3/4" EK | 11 | 580 | 200 | 1 | 175,28 |
| 181432512 | 1"1/4 | 3/4" EK | 12 | 630 | 200 | 1 | 188,43 |
| 181432513 | 1"1/4 | 3/4" EK | 13 | 680 | 200 | 1 | 201,66 |

COLLETTORI / MANIFOLDS

Collettori Inox / Inox Manifolds
AVANT FLOOR COMPONENTS



Collettore in acciaio inox AISI 304 1" - 1"1/4; Connessioni 3/4" EK - Interasse: 50 mm
AISI 304 stainless steel manifold 1" - 1"1/4; 3/4" Eurocone connections - Center hole distance 50 mm
Verteiler aus rostfreiem Edelstahl AISI 304 1" - 1"1/4; 3/4" Anschlüsse Eurokonus - Abstand 50 mm
Collecteur en acier inox AISI 304 1" - 1"1/4; connexion 3/4" eurocone - entraxes 50mm
Коллектор из нержавеющей стали AISI 304, размеры 1" - 1"1/4; 3/4", соединение Евроконус, межосевое расстояние 50 мм

IVR 875 CS



Collettore di ritorno con valvole, valvola sfogo aria e rubinetto di carico/scarico acqua
Return manifold with valves, air vent and fill & drain valve
Rücklaufverteiler mit Ventilen, Luftablassventil und Ein-/Ablassventil
Collecteur de retour avec vannes, vanne de purge d'air et robinet de chargement/déchargement
Обратный коллектор с термостатическими клапанами, воздухоотводчиком и дренажным клапаном

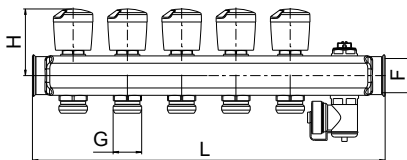

| Cod./Code | (F) Misura/Size | (G) Attacco/Connection | Vie/Ways | L(mm) | H(mm) | □/田 | € |
|-----------|-----------------|------------------------|----------|-------|-------|-----|--------|
| 187510502 | 1" | 3/4" EK | 2 | 175 | 61 | 6 | 36,00 |
| 187510503 | 1" | 3/4" EK | 3 | 225 | 61 | 4 | 46,84 |
| 187510504 | 1" | 3/4" EK | 4 | 275 | 61 | 4 | 58,02 |
| 187510505 | 1" | 3/4" EK | 5 | 325 | 61 | 4 | 68,87 |
| 187510506 | 1" | 3/4" EK | 6 | 375 | 61 | 6 | 79,59 |
| 187510507 | 1" | 3/4" EK | 7 | 425 | 61 | 6 | 90,91 |
| 187510508 | 1" | 3/4" EK | 8 | 475 | 61 | 6 | 101,65 |
| 187510509 | 1" | 3/4" EK | 9 | 525 | 61 | 6 | 111,09 |
| 187510510 | 1" | 3/4" EK | 10 | 575 | 61 | 6 | 122,16 |
| 187510511 | 1" | 3/4" EK | 11 | 625 | 61 | 6 | 132,78 |
| 187510512 | 1" | 3/4" EK | 12 | 675 | 61 | 6 | 143,37 |
| 187512506 | 1"1/4 | 3/4" EK | 6 | 375 | 66 | 1 | 84,05 |
| 187512507 | 1"1/4 | 3/4" EK | 7 | 425 | 66 | 1 | 95,51 |
| 187512508 | 1"1/4 | 3/4" EK | 8 | 475 | 66 | 1 | 107,00 |
| 187512509 | 1"1/4 | 3/4" EK | 9 | 525 | 66 | 1 | 118,49 |
| 187512510 | 1"1/4 | 3/4" EK | 10 | 575 | 66 | 1 | 129,94 |
| 187512511 | 1"1/4 | 3/4" EK | 11 | 625 | 66 | 1 | 141,40 |
| 187512512 | 1"1/4 | 3/4" EK | 12 | 675 | 66 | 1 | 152,89 |

IVR 875



Collettore di ritorno con valvole manuali e volantini manuali
Return manifold with manual valves and manual handles
Rücklaufverteiler mit Regulierventil und Handrädern
Collecteur de retour avec vannes manuelles
Обратный коллектор с ручными регулируемыми клапанами

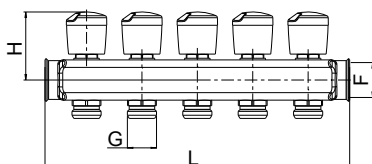

| Cod./Code | (F) Misura/Size | (G) Attacco/Connection | Vie/Ways | L(mm) | H(mm) | □/田 | € |
|-----------|-----------------|------------------------|----------|-------|-------|------|--------|
| 187511502 | 1" | 3/4" EK | 2 | 125 | 61 | 6/18 | 25,89 |
| 187511503 | 1" | 3/4" EK | 3 | 175 | 61 | 3/12 | 36,76 |
| 187511504 | 1" | 3/4" EK | 4 | 225 | 61 | 3/9 | 48,07 |
| 187511505 | 1" | 3/4" EK | 5 | 275 | 61 | 4 | 58,69 |
| 187511506 | 1" | 3/4" EK | 6 | 325 | 61 | 9 | 69,35 |
| 187511507 | 1" | 3/4" EK | 7 | 375 | 61 | 10 | 80,62 |
| 187511508 | 1" | 3/4" EK | 8 | 425 | 61 | 7 | 91,49 |
| 187511509 | 1" | 3/4" EK | 9 | 475 | 61 | 7 | 102,23 |
| 187511510 | 1" | 3/4" EK | 10 | 525 | 61 | 7 | 112,13 |
| 187511511 | 1" | 3/4" EK | 11 | 575 | 61 | 7 | 122,71 |
| 187511512 | 1" | 3/4" EK | 12 | 625 | 61 | 7 | 133,34 |
| 187511513 | 1" | 3/4" EK | 13 | 675 | 61 | 7 | 143,88 |
| 187513506 | 1"1/4 | 3/4" EK | 6 | 325 | 66 | 1 | 73,47 |
| 187513507 | 1"1/4 | 3/4" EK | 7 | 375 | 66 | 1 | 84,97 |
| 187513508 | 1"1/4 | 3/4" EK | 8 | 425 | 66 | 1 | 96,42 |
| 187513509 | 1"1/4 | 3/4" EK | 9 | 475 | 66 | 1 | 108,96 |
| 187513510 | 1"1/4 | 3/4" EK | 10 | 525 | 66 | 1 | 119,41 |
| 187513511 | 1"1/4 | 3/4" EK | 11 | 575 | 66 | 1 | 130,86 |
| 187513512 | 1"1/4 | 3/4" EK | 12 | 625 | 66 | 1 | 142,31 |
| 187513513 | 1"1/4 | 3/4" EK | 13 | 675 | 66 | 1 | 153,80 |

IVR 877 CS

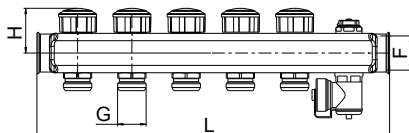

Collettore di ritorno con valvole termostattizzabili e cappellotti di regolazione, valvola sfogo aria e rubinetto di carico/scarico acqua

Return manifold with thermostatic valves and operating plastic caps, air vent and fill & drain valve

Rücklaufverteiler mit thermostatisierbaren Ventilen und Handrädern, Luftablassventil und Ein-/Ablassventil

Collecteur de retour avec vannes thermostatissables et chapeaux de réglage, vanne de purge d'air et robinet de chargement/déchargement

Обратный коллектор с термостатическими клапанами и регулируемыми колпачками, воздухоотводчиком и дренажным клапаном.

| Cod./Code | (F) Misura/Size | (G) Attacco/Connection | Vie/Ways | L(mm) | H(mm) | □/田 | € |
|-----------|-----------------|------------------------|----------|-------|-------|------|--------|
| 187710502 | 1" | 3/4" EK | 2 | 175 | 41 | 4/24 | 34,45 |
| 187710503 | 1" | 3/4" EK | 3 | 225 | 41 | 4/12 | 44,62 |
| 187710504 | 1" | 3/4" EK | 4 | 275 | 41 | 4 | 54,77 |
| 187710505 | 1" | 3/4" EK | 5 | 325 | 41 | 5 | 64,97 |
| 187710506 | 1" | 3/4" EK | 6 | 375 | 41 | 9 | 75,05 |
| 187710507 | 1" | 3/4" EK | 7 | 425 | 41 | 8 | 85,35 |
| 187710508 | 1" | 3/4" EK | 8 | 475 | 41 | 8 | 95,52 |
| 187710509 | 1" | 3/4" EK | 9 | 525 | 41 | 8 | 104,35 |
| 187710510 | 1" | 3/4" EK | 10 | 575 | 41 | 8 | 114,36 |
| 187710511 | 1" | 3/4" EK | 11 | 625 | 41 | 8 | 124,42 |
| 187710512 | 1" | 3/4" EK | 12 | 675 | 41 | 8 | 134,43 |
| 187712506 | 1"1/4 | 3/4" EK | 6 | 375 | 46 | 10 | 81,43 |
| 187712507 | 1"1/4 | 3/4" EK | 7 | 425 | 46 | 10 | 92,35 |
| 187712508 | 1"1/4 | 3/4" EK | 8 | 475 | 46 | 1 | 102,76 |
| 187712509 | 1"1/4 | 3/4" EK | 9 | 525 | 46 | 1 | 113,72 |
| 187712510 | 1"1/4 | 3/4" EK | 10 | 575 | 46 | 1 | 124,64 |
| 187712511 | 1"1/4 | 3/4" EK | 11 | 625 | 46 | 1 | 135,56 |
| 187712512 | 1"1/4 | 3/4" EK | 12 | 675 | 46 | 1 | 146,52 |

IVR 877

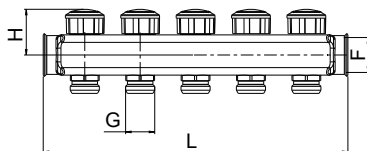

Collettore di ritorno con valvole termostattizzabili e cappellotti di regolazione

Return manifold with thermostatic valves and operating manual caps

Rücklaufverteiler mit Regulierventilen (für thermoelektrischen Kopf) und Handrädern

Collecteur de retour avec vannes thermostatissables, et chapeaux de réglage

Обратный коллектор с термостатическими клапанами и регулируемыми колпачками

| Cod./Code | (F) Misura/Size | (G) Attacco/Connection | Vie/Ways | L(mm) | H(mm) | □/田 | € |
|-----------|-----------------|------------------------|----------|-------|-------|------|--------|
| 187711502 | 1" | 3/4" EK | 2 | 125 | 41 | 4/24 | 24,21 |
| 187711503 | 1" | 3/4" EK | 3 | 175 | 41 | 4/24 | 34,51 |
| 187711504 | 1" | 3/4" EK | 4 | 225 | 41 | 8 | 44,58 |
| 187711505 | 1" | 3/4" EK | 5 | 275 | 41 | 8 | 54,72 |
| 187711506 | 1" | 3/4" EK | 6 | 325 | 41 | 5 | 65,04 |
| 187711507 | 1" | 3/4" EK | 7 | 375 | 41 | 9 | 75,13 |
| 187711508 | 1" | 3/4" EK | 8 | 425 | 41 | 8 | 85,42 |
| 187711509 | 1" | 3/4" EK | 9 | 475 | 41 | 8 | 95,59 |
| 187711510 | 1" | 3/4" EK | 10 | 525 | 41 | 8 | 104,42 |
| 187711511 | 1" | 3/4" EK | 11 | 575 | 41 | 8 | 114,43 |
| 187711512 | 1" | 3/4" EK | 12 | 625 | 41 | 8 | 124,48 |
| 187711513 | 1" | 3/4" EK | 13 | 675 | 41 | 8 | 134,50 |
| 187713506 | 1"1/4 | 3/4" EK | 6 | 325 | 46 | 1 | 70,29 |
| 187713507 | 1"1/4 | 3/4" EK | 7 | 375 | 46 | 1 | 81,26 |
| 187713508 | 1"1/4 | 3/4" EK | 8 | 425 | 46 | 1 | 92,18 |
| 187713509 | 1"1/4 | 3/4" EK | 9 | 475 | 46 | 1 | 103,14 |
| 187713510 | 1"1/4 | 3/4" EK | 10 | 525 | 46 | 1 | 114,10 |
| 187713511 | 1"1/4 | 3/4" EK | 11 | 575 | 46 | 1 | 125,03 |
| 187713512 | 1"1/4 | 3/4" EK | 12 | 625 | 46 | 1 | 135,95 |
| 187713513 | 1"1/4 | 3/4" EK | 13 | 675 | 46 | 1 | 146,91 |

IVR 877/R

NEW

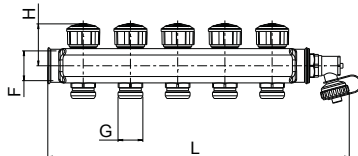

Collettore di ritorno con valvole termostattizzabili con cappello di regolazione e con rubinetto di carico/scarico acqua

Outlet manifold with thermostatic valves with operating plastic cap and fill & drain valve

Rücklaufverteiler mit thermostatisierbaren Ventilen mit Einstellkappe und Ein-/Ablassventil

Collecteur de retour avec vannes thermostatissables avec chapeau de réglage et avec robinet de chargement/déchargement

Обратный коллектор с термостатическими клапанами, регулирующим колпачком и дренажным клапаном.

| Cod./Code | (F) Misura/Size | (G) Attacco/Connection | Vie/Ways | L(mm) | H(mm) | □/田 | € |
|------------|-----------------|------------------------|----------|-------|-------|-----|--------|
| 1877R11502 | 1" | 3/4" EK | 2 | 169 | 41 | 1 | 31,74 |
| 1877R11503 | 1" | 3/4" EK | 3 | 219 | 41 | 1 | 41,91 |
| 1877R11504 | 1" | 3/4" EK | 4 | 269 | 41 | 1 | 51,99 |
| 1877R11505 | 1" | 3/4" EK | 5 | 319 | 41 | 1 | 62,13 |
| 1877R11506 | 1" | 3/4" EK | 6 | 369 | 41 | 1 | 72,44 |
| 1877R11507 | 1" | 3/4" EK | 7 | 419 | 41 | 1 | 82,54 |
| 1877R11508 | 1" | 3/4" EK | 8 | 469 | 41 | 1 | 92,83 |
| 1877R11509 | 1" | 3/4" EK | 9 | 519 | 41 | 1 | 103,00 |
| 1877R11510 | 1" | 3/4" EK | 10 | 569 | 41 | 1 | 111,82 |
| 1877R11511 | 1" | 3/4" EK | 11 | 619 | 41 | 1 | 121,84 |
| 1877R11512 | 1" | 3/4" EK | 12 | 669 | 41 | 1 | 131,89 |
| 1877R11513 | 1" | 3/4" EK | 13 | 719 | 41 | 1 | 141,90 |

IVR 878 CS

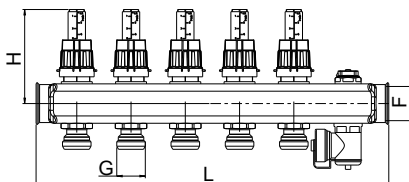

Collettore di mandata con misuratori di portata 0,5-5 lt/min. valvola sfogo aria, rubinetto di carico/scarico acqua

Inlet manifold with flow meters 0,5-5 L/min, air vent and fill & drain valve

Vorlaufverteiler mit Durchflussmessern 0,5-5 lt/min. Luftablassventil und Ein-/Ablassventil

Collecteur d'alimentation avec débitmètres 0,5-5 lt/min., vanne de purge de l'air et robinet de chargement/déchargement

Входной коллектор с расходомерами 0,5-5 л/мин, воздухоотводчиком и дренажным клапаном

| Cod./Code | (F) Misura/Size | (G) Attacco/Connection | Vie/Ways | L(mm) | H(mm) | □/田 | € |
|-----------|-----------------|------------------------|----------|-------|-------|-----|--------|
| 187810502 | 1" | 3/4" EK | 2 | 175 | 93 | 1 | 42,24 |
| 187810503 | 1" | 3/4" EK | 3 | 225 | 93 | 1 | 56,20 |
| 187810504 | 1" | 3/4" EK | 4 | 275 | 93 | 1 | 70,54 |
| 187810505 | 1" | 3/4" EK | 5 | 325 | 93 | 1 | 84,85 |
| 187810506 | 1" | 3/4" EK | 6 | 375 | 93 | 1 | 98,37 |
| 187810507 | 1" | 3/4" EK | 7 | 425 | 93 | 1 | 112,72 |
| 187810508 | 1" | 3/4" EK | 8 | 475 | 93 | 1 | 126,68 |
| 187810509 | 1" | 3/4" EK | 9 | 525 | 93 | 1 | 139,26 |
| 187810510 | 1" | 3/4" EK | 10 | 575 | 93 | 1 | 153,45 |
| 187810511 | 1" | 3/4" EK | 11 | 625 | 93 | 1 | 167,21 |
| 187810512 | 1" | 3/4" EK | 12 | 675 | 93 | 1 | 180,94 |
| 187812506 | 1"1/4 | 3/4" EK | 6 | 375 | 98 | 1 | 107,93 |
| 187812507 | 1"1/4 | 3/4" EK | 7 | 425 | 98 | 1 | 123,67 |
| 187812508 | 1"1/4 | 3/4" EK | 8 | 475 | 98 | 1 | 138,98 |
| 187812509 | 1"1/4 | 3/4" EK | 9 | 525 | 98 | 1 | 154,30 |
| 187812510 | 1"1/4 | 3/4" EK | 10 | 575 | 98 | 1 | 170,04 |
| 187812511 | 1"1/4 | 3/4" EK | 11 | 625 | 98 | 1 | 185,32 |
| 187812512 | 1"1/4 | 3/4" EK | 12 | 675 | 98 | 1 | 200,64 |

IVR 878



Collettore di mandata con misuratori di portata 0,5-5 lt/min.

Inlet manifold with flow meters 0,5-5 L/min

Vorlaufverteiler mit Durchflussmessern 0,5-5 lt/min

Collecteur d'alimentation avec débitmètres 0,5-5 lt/min

Входной коллектор с расходомерами 0,5-5 л/мин

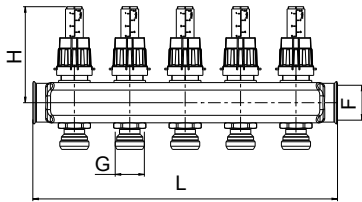

| Cod./Code | (F) Misura/Size | (G) Attacco/Connection | Vie/Ways | L(mm) | H(mm) | □/田 | € |
|-----------|-----------------|------------------------|----------|-------|-------|-----|--------|
| 187811502 | 1" | 3/4" EK | 2 | 125 | 93 | 1 | 32,09 |
| 187811503 | 1" | 3/4" EK | 3 | 175 | 93 | 1 | 46,04 |
| 187811504 | 1" | 3/4" EK | 4 | 225 | 93 | 1 | 60,45 |
| 187811505 | 1" | 3/4" EK | 5 | 275 | 93 | 1 | 74,32 |
| 187811506 | 1" | 3/4" EK | 6 | 325 | 93 | 1 | 88,63 |
| 187811507 | 1" | 3/4" EK | 7 | 375 | 93 | 1 | 102,61 |
| 187811508 | 1" | 3/4" EK | 8 | 425 | 93 | 1 | 116,50 |
| 187811509 | 1" | 3/4" EK | 9 | 475 | 93 | 1 | 130,46 |
| 187811510 | 1" | 3/4" EK | 10 | 525 | 93 | 1 | 143,50 |
| 187811511 | 1" | 3/4" EK | 11 | 575 | 93 | 1 | 157,23 |
| 187811512 | 1" | 3/4" EK | 12 | 625 | 93 | 1 | 170,99 |
| 187811513 | 1" | 3/4" EK | 13 | 675 | 93 | 1 | 172,27 |
| | | | | | | | |
| 187813506 | 1"1/4 | 3/4" EK | 6 | 325 | 98 | 1 | 97,35 |
| 187813507 | 1"1/4 | 3/4" EK | 7 | 375 | 98 | 1 | 113,13 |
| 187813508 | 1"1/4 | 3/4" EK | 8 | 425 | 98 | 1 | 128,41 |
| 187813509 | 1"1/4 | 3/4" EK | 9 | 475 | 98 | 1 | 143,72 |
| 187813510 | 1"1/4 | 3/4" EK | 10 | 525 | 98 | 1 | 159,50 |
| 187813511 | 1"1/4 | 3/4" EK | 11 | 575 | 98 | 1 | 174,78 |
| 187813512 | 1"1/4 | 3/4" EK | 12 | 625 | 98 | 1 | 190,06 |
| 187813513 | 1"1/4 | 3/4" EK | 13 | 675 | 98 | 1 | 205,84 |

IVR 878/R

NEW



Collettore di mandata con misuratori di portata 0,5-5 lt/min e con rubinetto di carico/scarico acqua

Inlet manifold with flow meters 0.5-5 L/min and fill & drain valve

Vorlaufverteiler mit Durchflussmesser 0,5-5 lt/Min. und Ein-/Ablassventil

Collecteur d'alimentation avec mesureur de débit 0,5-5 lt/min et avec robinet de chargement/déchargement

Входной коллектор с расходомерами 0,5-5 л/мин и дренажным клапаном

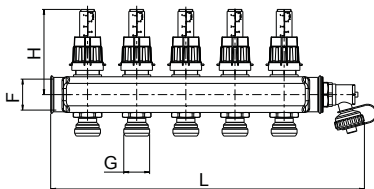

| Cod./Code | (F) Misura/Size | (G) Attacco/Connection | Vie/Ways | L(mm) | H(mm) | □/田 | € |
|------------|-----------------|------------------------|----------|-------|-------|-----|--------|
| 1878R11502 | 1" | 3/4" EK | 2 | 169 | 93 | 1 | 39,66 |
| 1878R11503 | 1" | 3/4" EK | 3 | 219 | 93 | 1 | 53,45 |
| 1878R11504 | 1" | 3/4" EK | 4 | 269 | 93 | 1 | 67,86 |
| 1878R11505 | 1" | 3/4" EK | 5 | 319 | 93 | 1 | 81,73 |
| 1878R11506 | 1" | 3/4" EK | 6 | 369 | 93 | 1 | 96,03 |
| 1878R11507 | 1" | 3/4" EK | 7 | 419 | 93 | 1 | 110,02 |
| 1878R11508 | 1" | 3/4" EK | 8 | 469 | 93 | 1 | 123,91 |
| 1878R11509 | 1" | 3/4" EK | 9 | 519 | 93 | 1 | 137,87 |
| 1878R11510 | 1" | 3/4" EK | 10 | 569 | 93 | 1 | 150,90 |
| 1878R11511 | 1" | 3/4" EK | 11 | 619 | 93 | 1 | 164,63 |
| 1878R11512 | 1" | 3/4" EK | 12 | 669 | 93 | 1 | 178,40 |
| 1878R11513 | 1" | 3/4" EK | 13 | 719 | 93 | 1 | 179,68 |

IVR 879 CS



Collettore di mandata con detentori micrometrici, valvola sfogo aria, rubinetto di carico/scarico acqua
Inlet manifold with micrometric lockshields, air vent, fill & drain valve

Vorlaufverteiler mit mikrometrischen Rücklaufverschraubungen und Ein-/Ablassventil

Collecteur d'alimentation avec coudes de réglage micrométriques, vanne de purge de l'air, robinet de chargement/déchargement

Входной коллектор с микрометрическими отсекающими клапанами, воздухоотводчиком и дренажным клапаном

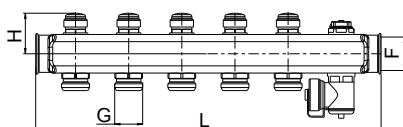

| Cod./Code | (F) Misura/Size | (G) Attacco/Connection | Vie/Ways | L(mm) | H(mm) | □/田 | € |
|-----------|-----------------|------------------------|----------|-------|-------|-----|--------|
| 187910502 | 1" | 3/4" EK | 2 | 175 | 38 | 1 | 31,38 |
| 187910503 | 1" | 3/4" EK | 3 | 225 | 38 | 1 | 39,94 |
| 187910504 | 1" | 3/4" EK | 4 | 275 | 38 | 1 | 48,50 |
| 187910505 | 1" | 3/4" EK | 5 | 325 | 38 | 1 | 57,11 |
| 187910506 | 1" | 3/4" EK | 6 | 375 | 38 | 1 | 65,61 |
| 187910507 | 1" | 3/4" EK | 7 | 425 | 38 | 1 | 74,31 |
| 187910508 | 1" | 3/4" EK | 8 | 475 | 38 | 1 | 82,89 |
| 187910509 | 1" | 3/4" EK | 9 | 525 | 38 | 1 | 90,12 |
| 187910510 | 1" | 3/4" EK | 10 | 575 | 38 | 1 | 98,54 |
| 187910511 | 1" | 3/4" EK | 11 | 625 | 38 | 1 | 106,99 |
| 187910512 | 1" | 3/4" EK | 12 | 675 | 38 | 1 | 115,41 |
| 187912506 | 1"1/4 | 3/4" EK | 6 | 375 | 43 | 1 | 71,85 |
| 187912507 | 1"1/4 | 3/4" EK | 7 | 425 | 43 | 1 | 81,18 |
| 187912508 | 1"1/4 | 3/4" EK | 8 | 475 | 43 | 1 | 89,99 |
| 187912509 | 1"1/4 | 3/4" EK | 9 | 525 | 43 | 1 | 99,35 |
| 187912510 | 1"1/4 | 3/4" EK | 10 | 575 | 43 | 1 | 108,68 |
| 187912511 | 1"1/4 | 3/4" EK | 11 | 625 | 43 | 1 | 118,01 |
| 187912512 | 1"1/4 | 3/4" EK | 12 | 675 | 43 | 1 | 127,37 |

IVR 879



Collettore di mandata con detentori micrometrici

Inlet manifold with micrometric lockshields

Vorlaufverteiler mit mikrometrischen Rücklaufverschraubungen

Collecteur d'alimentation avec coudes de réglage micrométriques

Входной коллектор с микрометрическими отсекающими клапанами

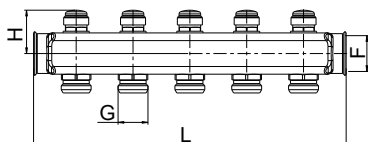

| Cod./Code | (F) Misura/Size | (G) Attacco/Connection | Vie/Ways | L(mm) | H(mm) | □/田 | € |
|-----------|-----------------|------------------------|----------|-------|-------|-----|--------|
| 187911502 | 1" | 3/4" EK | 2 | 125 | 38 | 1 | 21,02 |
| 187911503 | 1" | 3/4" EK | 3 | 175 | 38 | 1 | 29,75 |
| 187911504 | 1" | 3/4" EK | 4 | 225 | 38 | 1 | 38,20 |
| 187911505 | 1" | 3/4" EK | 5 | 275 | 38 | 1 | 46,75 |
| 187911506 | 1" | 3/4" EK | 6 | 325 | 38 | 1 | 55,37 |
| 187911507 | 1" | 3/4" EK | 7 | 375 | 38 | 1 | 63,96 |
| 187911508 | 1" | 3/4" EK | 8 | 425 | 38 | 1 | 72,65 |
| 187911509 | 1" | 3/4" EK | 9 | 475 | 38 | 1 | 81,23 |
| 187911510 | 1" | 3/4" EK | 10 | 525 | 38 | 1 | 88,46 |
| 187911511 | 1" | 3/4" EK | 11 | 575 | 38 | 1 | 96,87 |
| 187911512 | 1" | 3/4" EK | 12 | 625 | 38 | 1 | 105,33 |
| 187911513 | 1" | 3/4" EK | 13 | 675 | 38 | 1 | 113,75 |
| 187913506 | 1"1/4 | 3/4" EK | 6 | 325 | 43 | 1 | 60,72 |
| 187913507 | 1"1/4 | 3/4" EK | 7 | 375 | 43 | 1 | 70,08 |
| 187913508 | 1"1/4 | 3/4" EK | 8 | 425 | 43 | 1 | 79,41 |
| 187913509 | 1"1/4 | 3/4" EK | 9 | 475 | 43 | 1 | 88,78 |
| 187913510 | 1"1/4 | 3/4" EK | 10 | 525 | 43 | 1 | 98,14 |
| 187913511 | 1"1/4 | 3/4" EK | 11 | 575 | 43 | 1 | 107,47 |
| 187913512 | 1"1/4 | 3/4" EK | 12 | 625 | 43 | 1 | 116,79 |
| 187913513 | 1"1/4 | 3/4" EK | 13 | 675 | 43 | 1 | 126,16 |

IVR 879/R

NEW

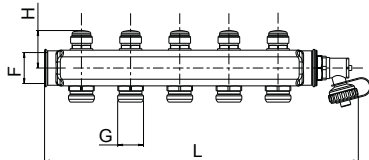

Collettore di mandata con detentori micrometrici e con rubinetto di carico/scarico acqua

Inlet manifold with micrometric lockshields and fill & drain valve

Vorlaufverteiler mit mikrometrischen Rücklaufverschraubungen und Ein-/Ablassventil

Collecteur d'alimentation avec coudes de réglage micrométriques et avec robinet de chargement/déchargement

Входной коллектор с микрометрическими отсекающими вентилями и дренажным клапаном

| Cod./Code | (F) Misura/Size | (G) Attacco/Connection | Vie/Ways | L(mm) | H(mm) | □/田 | € |
|------------|-----------------|------------------------|----------|-------|-------|-----|--------|
| 1879R11502 | 1" | 3/4" EK | 2 | 169 | 38 | 1 | 28,55 |
| 1879R11503 | 1" | 3/4" EK | 3 | 219 | 38 | 1 | 37,15 |
| 1879R11504 | 1" | 3/4" EK | 4 | 269 | 38 | 1 | 45,61 |
| 1879R11505 | 1" | 3/4" EK | 5 | 319 | 38 | 1 | 54,15 |
| 1879R11506 | 1" | 3/4" EK | 6 | 369 | 38 | 1 | 62,78 |
| 1879R11507 | 1" | 3/4" EK | 7 | 419 | 38 | 1 | 71,36 |
| 1879R11508 | 1" | 3/4" EK | 8 | 469 | 38 | 1 | 80,06 |
| 1879R11509 | 1" | 3/4" EK | 9 | 519 | 38 | 1 | 88,63 |
| 1879R11510 | 1" | 3/4" EK | 10 | 569 | 38 | 1 | 95,86 |
| 1879R11511 | 1" | 3/4" EK | 11 | 619 | 38 | 1 | 104,28 |
| 1879R11512 | 1" | 3/4" EK | 12 | 669 | 38 | 1 | 112,74 |
| 1879R11513 | 1" | 3/4" EK | 13 | 719 | 38 | 1 | 121,15 |

COLLETTORI / MANIFOLDS

Collettori Inox / Inox Manifolds
AVANT FLOOR BASIC



Collettore in acciaio inox AISI 304 1" - 1"1/4; Interasse: 50 mm

AISI 304 stainless steel manifold 1" - 1"1/4; Center hole distance 50 mm

Verteiler aus rostfreiem Stahl AISI 304 1" - 1"1/4 Anschlüsse; Abstand 50 mm

Collecteur en acier inox AISI 304 1" - 1"1/4; entraxes 50mm

Коллектор из нержавеющей стали AISI 304, размеры 1" - 1"1/4 ; соединения Евроконус, межосевое расстояние 50 мм

IVR 871

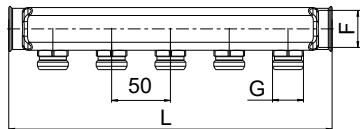

| Cod./Code | (F) Misura/Size | (G) Attacco/Connection | Vie/Ways | L(mm) | H(mm) | □/田 | € |
|-----------|-----------------|------------------------|----------|-------|-------|------|-------|
| 187111502 | 1" | 3/4" EK | 2 | 125 | | 6/36 | 17,31 |
| 187111503 | 1" | 3/4" EK | 3 | 175 | | 6/36 | 24,00 |
| 187111504 | 1" | 3/4" EK | 4 | 225 | | 6/18 | 30,62 |
| 187111505 | 1" | 3/4" EK | 5 | 275 | | 10 | 37,14 |
| 187111506 | 1" | 3/4" EK | 6 | 325 | | 8 | 43,81 |
| 187111507 | 1" | 3/4" EK | 7 | 375 | | 12 | 50,40 |
| 187111508 | 1" | 3/4" EK | 8 | 425 | | 12 | 57,05 |
| 187111509 | 1" | 3/4" EK | 9 | 475 | | 12 | 63,66 |
| 187111510 | 1" | 3/4" EK | 10 | 525 | | 16 | 70,28 |
| 187111511 | 1" | 3/4" EK | 11 | 575 | | 16 | 76,88 |
| 187111512 | 1" | 3/4" EK | 12 | 625 | | 16 | 83,53 |
| 187111513 | 1" | 3/4" EK | 13 | 675 | | 16 | 89,88 |
| 187113506 | 1"1/4 | 3/4" EK | 6 | 325 | | 1 | 47,56 |
| 187113507 | 1"1/4 | 3/4" EK | 7 | 375 | | 1 | 54,67 |
| 187113508 | 1"1/4 | 3/4" EK | 8 | 425 | | 1 | 61,73 |
| 187113509 | 1"1/4 | 3/4" EK | 9 | 475 | | 1 | 68,85 |
| 187113510 | 1"1/4 | 3/4" EK | 10 | 525 | | 1 | 75,95 |
| 187113511 | 1"1/4 | 3/4" EK | 11 | 575 | | 1 | 83,02 |
| 187113512 | 1"1/4 | 3/4" EK | 12 | 625 | | 1 | 90,09 |
| 187113513 | 1"1/4 | 3/4" EK | 13 | 675 | | 1 | 97,20 |

IVR 868

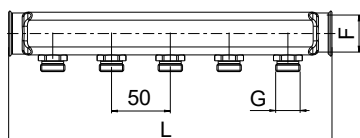

| Cod./Code | (F) Misura/Size | (G) Attacco/Connection | Vie/Ways | L(mm) | □/田 | € |
|-----------|-----------------|------------------------|----------|-------|------|-------|
| 186811502 | 1" | 1/2" | 2 | 125 | 6/36 | 14,22 |
| 186811503 | 1" | 1/2" | 3 | 175 | 6/36 | 19,36 |
| 186811504 | 1" | 1/2" | 4 | 225 | 6/18 | 24,50 |
| 186811505 | 1" | 1/2" | 5 | 275 | 10 | 29,41 |
| 186811506 | 1" | 1/2" | 6 | 325 | 8 | 34,39 |
| 186811507 | 1" | 1/2" | 7 | 375 | 12 | 39,51 |
| 186811508 | 1" | 1/2" | 8 | 425 | 12 | 44,50 |
| 186811509 | 1" | 1/2" | 9 | 475 | 12 | 49,55 |
| 186811510 | 1" | 1/2" | 10 | 525 | 16 | 54,61 |
| 186811511 | 1" | 1/2" | 11 | 575 | 16 | 59,67 |
| 186811512 | 1" | 1/2" | 12 | 625 | 16 | 64,76 |
| 186811513 | 1" | 1/2" | 13 | 675 | 16 | 69,78 |
| | | | | | | |
| 186813506 | 1"1/4 | 1/2" | 6 | 325 | 1 | 38,28 |
| 186813507 | 1"1/4 | 1/2" | 7 | 375 | 1 | 43,84 |
| 186813508 | 1"1/4 | 1/2" | 8 | 425 | 1 | 49,36 |
| 186813509 | 1"1/4 | 1/2" | 9 | 475 | 1 | 54,92 |
| 186813510 | 1"1/4 | 1/2" | 10 | 525 | 1 | 60,49 |
| 186813511 | 1"1/4 | 1/2" | 11 | 575 | 1 | 66,01 |
| 186813512 | 1"1/4 | 1/2" | 12 | 625 | 1 | 71,53 |
| 186813513 | 1"1/4 | 1/2" | 13 | 675 | 1 | 69,78 |

IVR 869

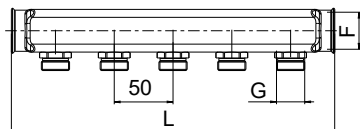

| Cod./Code | (F) Misura/Size | (G) Attacco/Connection | Vie/Ways | L(mm) | □/田 | € |
|-----------|-----------------|------------------------|----------|-------|------|-------|
| 186911502 | 1" | 24-19 | 2 | 125 | 6/36 | 14,99 |
| 186911503 | 1" | 24-19 | 3 | 175 | 6/36 | 20,50 |
| 186911504 | 1" | 24-19 | 4 | 225 | 6/18 | 26,04 |
| 186911505 | 1" | 24-19 | 5 | 275 | 10 | 31,33 |
| 186911506 | 1" | 24-19 | 6 | 325 | 8 | 36,70 |
| 186911507 | 1" | 24-19 | 7 | 375 | 12 | 42,14 |
| 186911508 | 1" | 24-19 | 8 | 425 | 12 | 47,58 |
| 186911509 | 1" | 24-19 | 9 | 475 | 12 | 53,02 |
| 186911510 | 1" | 24-19 | 10 | 525 | 16 | 58,46 |
| 186911511 | 1" | 24-19 | 11 | 575 | 16 | 63,90 |
| 186911512 | 1" | 24-19 | 12 | 625 | 16 | 69,38 |
| 186911513 | 1" | 24-19 | 13 | 675 | 16 | 74,78 |
| | | | | | | |
| 186913506 | 1"1/4 | 24-19 | 6 | 325 | 1 | 40,59 |
| 186913507 | 1"1/4 | 24-19 | 7 | 375 | 1 | 46,53 |
| 186913508 | 1"1/4 | 24-19 | 8 | 425 | 1 | 52,44 |
| 186913509 | 1"1/4 | 24-19 | 9 | 475 | 1 | 58,39 |
| 186913510 | 1"1/4 | 24-19 | 10 | 525 | 1 | 64,34 |
| 186913511 | 1"1/4 | 24-19 | 11 | 575 | 1 | 70,24 |
| 186913512 | 1"1/4 | 24-19 | 12 | 625 | 1 | 76,15 |
| 186913513 | 1"1/4 | 24-19 | 13 | 675 | 1 | 82,10 |

IVR 867

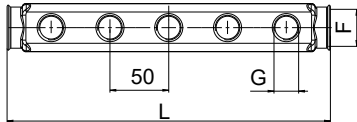

| Cod./Code | (F) Misura/Size | (G) Attacco/Connection | Vie/Ways | L(mm) | □/田 | € |
|-----------|-----------------|------------------------|----------|-------|------|-------|
| 186711502 | 1" | 1/2" F | 2 | 125 | 8/48 | 8,45 |
| 186711503 | 1" | 1/2" F | 3 | 175 | 8/48 | 11,57 |
| 186711504 | 1" | 1/2" F | 4 | 225 | 8/24 | 14,63 |
| 186711505 | 1" | 1/2" F | 5 | 275 | 12 | 17,62 |
| 186711506 | 1" | 1/2" F | 6 | 325 | 10 | 20,70 |
| 186711507 | 1" | 1/2" F | 7 | 375 | 18 | 23,71 |
| 186711508 | 1" | 1/2" F | 8 | 425 | 20 | 26,79 |
| 186711509 | 1" | 1/2" F | 9 | 475 | 20 | 29,73 |
| 186711510 | 1" | 1/2" F | 10 | 525 | 20 | 32,77 |
| 186711511 | 1" | 1/2" F | 11 | 575 | 20 | 35,82 |
| 186711512 | 1" | 1/2" F | 12 | 625 | 20 | 38,90 |
| 186711513 | 1" | 1/2" F | 13 | 675 | 20 | 41,90 |
| | | | | | | |
| 186713506 | 1"1/4 | 1/2" F | 6 | 325 | 8 | 24,63 |
| 186713507 | 1"1/4 | 1/2" F | 7 | 375 | 8 | 28,18 |
| 186713508 | 1"1/4 | 1/2" F | 8 | 425 | 14 | 31,69 |
| 186713509 | 1"1/4 | 1/2" F | 9 | 475 | 14 | 35,25 |
| 186713510 | 1"1/4 | 1/2" F | 10 | 525 | 16 | 38,83 |
| 186713511 | 1"1/4 | 1/2" F | 11 | 575 | 16 | 42,34 |
| 186713512 | 1"1/4 | 1/2" F | 12 | 625 | 16 | 45,85 |
| 186713513 | 1"1/4 | 1/2" F | 13 | 675 | 16 | 49,40 |

IVR MULTIKLIMA Distribuzione / Distribution



IVR MULTIKLIMA 525



Interasse attacco tubazioni: 277 mm.
Pipe connection center to center: 277 mm.

Modulo di distribuzione per alta e bassa temperatura con collettori in acciaio inox AISI 304 da 1" x 3/4" EK da 2 a 12 derivazioni con 2 derivazioni (o 3 su richiesta) per alta temperatura; collettori completi di: valvole d'intercettazione, valvole termostattizzabili, misuratori di portata, rubinetto orientabile di carico scarico, valvola sfiato aria. Gruppo di miscelazione modulante con servocomando elettrotermico e gruppo by-pass con termostato di sicurezza, detentore micrometrico e pozzetto porta sonda.

Water distribution cabinet for high and low temperature with AISI 304 stainless steel manifolds 1"x3/4" EK, 2-12 ways; with 2 ways (or 3 on demand) for high temperature; fitted with: interception valves, thermostatic valves, flow meters, rotatable drain valve and air vent. Modulating mixing unit with electrothermal actuator and by-pass group with safety thermostat, micrometric lockshield and sensor connection.

Verteilermodul für hohe und niedrige Temperatur mit Verteilerrohren aus rostfreiem Stahl AISI 304 mit Ek Übergang 1"x3/4", mit 2-12 Abzweigungen (oder 3 auf Anfrage) für hohe Temperatur; ausgestattet mit: Absperrventilen, thermostatisierbaren Ventilen, Durchflussmessern, drehbarem Ein-/Ablassventil und Luftablassventil. Modulierende Mischergruppe mit elektrothermischem Servosteuerung und Bypass-Gruppe mit Sicherheitsthermostat, mikrometrischem Regelventil und Sondenaufnahme.

Module de distribution pour haute et basse température, avec collecteurs en acier inoxydable AISI304, de 1" x 3/4" EK e 1" 1/4 x 3/4" EK, à 2 dérivation (ou 3 sur demande) pour température haute; pourvus de: vannes d'arrêt, vannes thermostatisables, débitmètres, robinet orientable de chargement/déchargement, vanne de purge de l'air. Groupe de mélange modulante avec servocommande électrothermique et groupe by-pass avec thermostat de sécurité, coude de réglage micrométrique et puisard porte-sonde.

Распределительный модуль для низкой и высокой температуры с коллекторами сделан из нержавеющей стали AISI 304 1" x 3/4" Евроконус, от 2 до 12 отводов, с двумя ответвлениями (с тремя - под заказ) для высокой температуры. Состоит из: шарового крана для насоса, термостатических клапанов, расходомера, дренажного крана, воздушного клапана и крепления. Также входит: модулирующая смесительная группа с термоэлектрическим приводом и группой бай-пасс с предохранительным термостатом, микрометрическим отсекающим вентилем и подключением температурного зонда.

| Cod. Sx/Left | Cod. Dx/Right | Vie/Ways | L(mm) | H(mm) | P(mm) | € |
|--------------|---------------|----------|-------|-------|-------|---------|
| 52503232GA | 52513232GA | 2 + 2 | 850 | 750 | 110 | 870,03 |
| 52503232GB | 52513232GB | 2 + 3 | 850 | 750 | 110 | 893,56 |
| 52503232GC | 52513232GC | 2 + 4 | 850 | 750 | 110 | 917,36 |
| 52503232GD | 52513232GD | 2 + 5 | 1000 | 750 | 110 | 961,48 |
| 52503232GE | 52513232GE | 2 + 6 | 1000 | 750 | 110 | 984,07 |
| 52503232GF | 52513232GF | 2 + 7 | 1000 | 750 | 110 | 1008,07 |
| 52503232GG | 52513232GG | 2 + 8 | 1200 | 750 | 110 | 1052,10 |
| 52503232GH | 52513232GH | 2 + 9 | 1200 | 750 | 110 | 1072,60 |
| 52503232GJ | 52513232GJ | 2 + 10 | 1200 | 750 | 110 | 1096,12 |
| 52503232GK | 52513232GK | 2 + 11 | 1200 | 750 | 110 | 1119,33 |
| 52503232GL | 52513232GL | 2 + 12 | 1300 | 750 | 110 | 1164,13 |

Versione con circolatore volumetrico in Classe A
Version with Class A volumetric pump
Ausführung mit Class A Umlaufpumpe
Version avec class A pompe volumétrique
Версия с циркуляционным насосом класса A

| Cod. Sx/Left | Cod. Dx/Right | Vie/Ways | L(mm) | H(mm) | P(mm) | € |
|--------------|---------------|----------|-------|-------|-------|---------|
| 52502232GA | 52512232GA | 2 + 2 | 850 | 750 | 110 | 772,53 |
| 52502232GB | 52512232GB | 2 + 3 | 850 | 750 | 110 | 796,06 |
| 52502232GC | 52512232GC | 2 + 4 | 850 | 750 | 110 | 819,86 |
| 52502232GD | 52512232GD | 2 + 5 | 1000 | 750 | 110 | 863,98 |
| 52502232GE | 52512232GE | 2 + 6 | 1000 | 750 | 110 | 886,57 |
| 52502232GF | 52512232GF | 2 + 7 | 1000 | 750 | 110 | 910,57 |
| 52502232GG | 52512232GG | 2 + 8 | 1200 | 750 | 110 | 954,60 |
| 52502232GH | 52512232GH | 2 + 9 | 1200 | 750 | 110 | 975,10 |
| 52502232GJ | 52512232GJ | 2 + 10 | 1200 | 750 | 110 | 998,62 |
| 52502232GK | 52512232GK | 2 + 11 | 1200 | 750 | 110 | 1021,83 |
| 52502232GL | 52512232GL | 2 + 12 | 1300 | 750 | 110 | 1066,63 |

Versione con circolatore a tre velocità (solo per paesi extra CEE)
Version with 3 speed pump (only for extra CEE country)
Ausführung mit 3-Gang-Pumpe (nur für Klein CEE-Land)
Version avec pompe à 3 vitesses (uniquement pour les pays extra CEE)
Версия с трехскоростным насосом (только для стран, не входящих в ЕС)

| Cod. Sx/Left | Cod. Dx/Right | Vie/Ways | L(mm) | H(mm) | P(mm) | € |
|--------------|---------------|----------|-------|-------|-------|--------|
| 52501232GA | 52511232GA | 2 + 2 | 850 | 750 | 110 | 651,00 |
| 52501232GB | 52511232GB | 2 + 3 | 850 | 750 | 110 | 674,53 |
| 52501232GC | 52511232GC | 2 + 4 | 850 | 750 | 110 | 698,33 |
| 52501232GD | 52511232GD | 2 + 5 | 1000 | 750 | 110 | 742,45 |
| 52501232GE | 52511232GE | 2 + 6 | 1000 | 750 | 110 | 765,04 |
| 52501232GF | 52511232GF | 2 + 7 | 1000 | 750 | 110 | 789,04 |
| 52501232GG | 52511232GG | 2 + 8 | 1200 | 750 | 110 | 833,07 |
| 52501232GH | 52511232GH | 2 + 9 | 1200 | 750 | 110 | 853,57 |
| 52501232GJ | 52511232GJ | 2 + 10 | 1200 | 750 | 110 | 877,09 |
| 52501232GK | 52511232GK | 2 + 11 | 1200 | 750 | 110 | 900,30 |
| 52501232GL | 52511232GL | 2 + 12 | 1300 | 750 | 110 | 945,10 |

Versione senza circolatore (con tronchetto spaziatore)
Version without pump (with pipes premounted)
Ausführung ohne Pumpe (mit Balken vormontiert)
Version sans pompe (avec des tuyaux pré-monté)
Версия без насоса (с предустановленными трубами)

IVR MULTIKLIMA 523



Interasse attacco tubazioni: 277 mm.
 Pipe connection center to center: 277 mm.

Modulo di distribuzione per alta e bassa temperatura con collettori in acciaio inox AISI 304 da 1" x 3/4" EK da 2 a 12 derivazioni con 2 derivazioni (o 3 su richiesta) per alta temperatura; collettori completi di: valvole d'intercettazione, valvole termostattizzabili, misuratori di portata, rubinetto orientabile di carico scarico, valvola sfiato aria. Gruppo di miscelazione a punto fisso con miscelatore termostatico e gruppo by-pass con termostato di sicurezza, detentore micrometrico e pozzetto porta sonda.

Water distribution cabinet for high and low temperature with AISI 304 stainless steel manifolds 1"x3/4" EK, 2-12 ways; with 2 ways (or 3 on demand) for high temperature; fitted with: interception valves, thermostatic valves, flow meters, rotatable drain valve and air vent. Mixing unit with fixed point with thermostatic head and by-pass group with safety thermostat, micrometric lockshield and sensor connection.

Verteilermodul für hohe und niedrige Temperatur, mit Verteilerröhren aus rostfreiem Stahl AISI 304 mit Ek Übergang 1"x3/4", mit 2-12 Abzweigungen (oder 3 auf Anfrage) für hohe Temperatur; ausgestattet mit: Absperrventilen, thermostatisierbaren Ventilen, Durchflussmessern, drehbarem Ein-/Ablassventil und Luftablassventil. Fest eingestellte Mischerguppe mit thermostatischem Kopf und Bypass-Gruppe mit Sicherheitsthermostat, mikrometrischem Regelventil und Sondenaufnahme.

Module de distribution pour haute et basse température avec collecteurs en acier inoxydable AISI304, de 1" x 3/4" EK, à 2 dérivation (ou 3 sur demande) pour température haute; pourvus de: vannes d'arrêt, vannes thermostatisables, débitmètres, robinet orientable de chargement/déchargement, vanne de purge de l'air. Groupe de mélange à point fixe avec mitigeur thermostatique et groupe by-pass avec thermostat de sécurité, coude de réglage micrométrique et puisard porte-sonde.

Распределительный модуль для низкой и высокой температуры с коллекторами из нержавеющей стали AISI 304 1" x 3/4" Евроконус, от 2 до 12 отводов, с двумя ниями (с тремя - под заказ) для высокой температуры. Состоит из: шарового крана для насоса, термостатического клапана (для термостатических головок), расходомера, дренажного крана, воздушного клапана и крепления. Также входит модулирующая смесительная группа с термостатическим вентилем и группой бай-пасс с предохранительным термостатом, микрометрическим отсекающим вентилем и подключением температурного зонда.

| Cod. Sx/Left | Cod. Dx/Right | Vie/Ways | L(mm) | H(mm) | P(mm) | € |
|--------------|---------------|----------|-------|-------|-------|---------|
| 52303231GA | 52313231GA | 2 + 2 | 850 | 750 | 110 | 891,70 |
| 52303231GB | 52313231GB | 2 + 3 | 850 | 750 | 110 | 915,23 |
| 52303231GC | 52313231GC | 2 + 4 | 850 | 750 | 110 | 939,03 |
| 52303231GD | 52313231GD | 2 + 5 | 1000 | 750 | 110 | 983,15 |
| 52303231GE | 52313231GE | 2 + 6 | 1000 | 750 | 110 | 1005,74 |
| 52303231GF | 52313231GF | 2 + 7 | 1000 | 750 | 110 | 1029,74 |
| 52303231GG | 52313231GG | 2 + 8 | 1200 | 750 | 110 | 1073,77 |
| 52303231GH | 52313231GH | 2 + 9 | 1200 | 750 | 110 | 1094,27 |
| 52303231GJ | 52313231GJ | 2 + 10 | 1200 | 750 | 110 | 1117,79 |
| 52303231GK | 52313231GK | 2 + 11 | 1200 | 750 | 110 | 1141,00 |
| 52303231GL | 52313231GL | 2 + 12 | 1300 | 750 | 110 | 1185,80 |

Versione con circolatore volumetrico in Classe A
 Version with Class A volumetric pump
 Ausführung mit Class A Umlaufpumpe
 Version avec class A pompe volumétrique
 Версия с циркуляционным насосом класса A

| Cod. Sx/Left | Cod. Dx/Right | Vie/Ways | L(mm) | H(mm) | P(mm) | € |
|--------------|---------------|----------|-------|-------|-------|---------|
| 52302231GA | 52312231GA | 2 + 2 | 850 | 750 | 110 | 790,37 |
| 52302231GB | 52312231GB | 2 + 3 | 850 | 750 | 110 | 813,90 |
| 52302231GC | 52312231GC | 2 + 4 | 850 | 750 | 110 | 837,70 |
| 52302231GD | 52312231GD | 2 + 5 | 1000 | 750 | 110 | 881,82 |
| 52302231GE | 52312231GE | 2 + 6 | 1000 | 750 | 110 | 904,41 |
| 52302231GF | 52312231GF | 2 + 7 | 1000 | 750 | 110 | 928,41 |
| 52302231GG | 52312231GG | 2 + 8 | 1200 | 750 | 110 | 972,44 |
| 52302231GH | 52312231GH | 2 + 9 | 1200 | 750 | 110 | 992,94 |
| 52302231GJ | 52312231GJ | 2 + 10 | 1200 | 750 | 110 | 1016,46 |
| 52302231GK | 52312231GK | 2 + 11 | 1200 | 750 | 110 | 1039,67 |
| 52302231GL | 52312231GL | 2 + 12 | 1300 | 750 | 110 | 1084,47 |

Versione con circolatore a tre velocità (solo per paesi extra CEE)
 Version with 3 speed pump (only for extra CEE country)
 Ausführung mit 3-Gang-Pumpe (nur für Klein CEE-Land)
 Version avec pompe à 3 vitesses (uniquement pour les pays extra CEE)
 Версия с трехскоростным насосом (только для стран, не входящих в ЕС)

| Cod. Sx/Left | Cod. Dx/Right | Vie/Ways | L(mm) | H(mm) | P(mm) | € |
|--------------|---------------|----------|-------|-------|-------|--------|
| 52301231GA | 52311231GA | 2 + 2 | 850 | 750 | 110 | 668,84 |
| 52301231GB | 52311231GB | 2 + 3 | 850 | 750 | 110 | 692,37 |
| 52301231GC | 52311231GC | 2 + 4 | 850 | 750 | 110 | 716,17 |
| 52301231GD | 52311231GD | 2 + 5 | 1000 | 750 | 110 | 760,29 |
| 52301231GE | 52311231GE | 2 + 6 | 1000 | 750 | 110 | 782,88 |
| 52301231GF | 52311231GF | 2 + 7 | 1000 | 750 | 110 | 806,88 |
| 52301231GG | 52311231GG | 2 + 8 | 1200 | 750 | 110 | 850,91 |
| 52301231GH | 52311231GH | 2 + 9 | 1200 | 750 | 110 | 871,41 |
| 52301231GJ | 52311231GJ | 2 + 10 | 1200 | 750 | 110 | 894,93 |
| 52301231GK | 52311231GK | 2 + 11 | 1200 | 750 | 110 | 918,14 |
| 52301231GL | 52311231GL | 2 + 12 | 1300 | 750 | 110 | 962,94 |

Versione senza circolatore (con tronchetto spaziatore)
 Version without pump (with pipes pre-mounted)
 Ausführung ohne Pumpe (mit Balken vormontiert)
 Version sans pompe (avec des tuyaux pré-montés)
 Версия без насоса (с предустановленными трубами)

IVR MULTIKLIMA 521



Interasse attacco tubazioni: 277 mm.
Pipe connection center to center: 277 mm.

Modulo di distribuzione per alta e bassa temperatura con collettori in acciaio inox AISI 304 da 1" x 3/4" EK, da 2 a 12 derivazioni; con 2 derivazioni (o 3 su richiesta) per alta temperatura; collettori completi di: valvole d'intercezione, valvole termostatzabili, misuratori di portata, rubinetto orientabile di carico scarico, valvola sfiato aria. Gruppo di miscelazione a punto fisso con testa termostatica e gruppo by-pass con termostato di sicurezza, detentore micrometrico e pozzetto porta sonda.

Water distribuion cabinet for high and low temperature with AISI 304 stainless steel manifolds 1"x3/4" EK, 2-12 ways; with 2 ways (or 3 on demand) for high temperature; fitted with: interception valves, thermostatic valves, flow meters, rotatable drain valve and air vent. Mixing unit with fixed point with thermostatic head and by-pass group with safety thermostat, micrometric lockshield and sensor connection.

Verteilermodul für hohe und niedrige Temperatur, mit Verteilerröhren aus rostfreiem Stahl AISI 304 mit Ek Übergang 1"x3/4", mit 2-12 Abzweigungen (oder 3 auf Anfrage) für hohe Temperatur; ausgestattet mit: Absperrentilen, thermostatisierbaren Ventilen, Durchflussmessern, drehbarem Ein-/Ablassventil und Luftablassventil. Fest eingestellte Mischerguppe mit thermostatischem Kopf und Bypass-Gruppe mit Sicherheitsthermostat, mikrometrischem Regelventil und Sondenaufnahme.

Module de distribution pour haute et basse température avec collecteurs en acier inoxydable AISI304, de 1" x 3/4" EK, à 2 dérivation (ou 3 sur demande) pour température haute; pourvus de: vannes d'arrêt, vannes thermostatisables, débitmètres, robinet orientable de chargement/déchargement, vanne de purge de l'air. Groupe de mélange à point fixe avec tête thermostatique et groupe by-pass avec thermostat de sécurité, coude de réglage micrométrique et puisard porte-sonde.

Распределительный модуль для низкой и высокой температуры с коллекторами и гидравлическим сепаратором сделан из нержавеющей стали AISI 304 1" x 3/4" Евроконус, от 2 до 12 отводов, с двумя ответвлениями (с тремя - под заказ) для высокой температуры. Состоит из: шарового крана для насоса, термостатического клапана (для термостатических головок), расходомера, дренажного крана, воздушного клапана и крепления. Также входит модулирующая смесительная группа с термостатической головкой и группой бай-пасс с предохранительным термостатом, микрометрическим отсекающим вентилем и подключением температурного зонда.

| Cod. Sx/Left | Cod. Dx/Right | Vie/Ways | L(mm) | H(mm) | P(mm) | € |
|--------------|---------------|----------|-------|-------|-------|---------|
| 52103230GA | 52113230GA | 2 + 2 | 850 | 750 | 110 | 789,86 |
| 52103230GB | 52113230GB | 2 + 3 | 850 | 750 | 110 | 813,39 |
| 52103230GC | 52113230GC | 2 + 4 | 850 | 750 | 110 | 837,19 |
| 52103230GD | 52113230GD | 2 + 5 | 1000 | 750 | 110 | 881,31 |
| 52103230GE | 52113230GE | 2 + 6 | 1000 | 750 | 110 | 903,90 |
| 52103230GF | 52113230GF | 2 + 7 | 1000 | 750 | 110 | 927,90 |
| 52103230GG | 52113230GG | 2 + 8 | 1200 | 750 | 110 | 971,93 |
| 52103230GH | 52113230GH | 2 + 9 | 1200 | 750 | 110 | 992,43 |
| 52103230GJ | 52113230GJ | 2 + 10 | 1200 | 750 | 110 | 1015,95 |
| 52103230GK | 52113230GK | 2 + 11 | 1200 | 750 | 110 | 1039,16 |
| 52103230GL | 52113230GL | 2 + 12 | 1300 | 750 | 110 | 1083,96 |

Versione con circolatore volumetrico in Classe A
Version with Class A volumetric pump
Ausführung mit Class A Umlaufpumpe
Version avec class A pompe volumétrique
Версия с циркуляционным насосом класса А

| Cod. Sx/Left | Cod. Dx/Right | Vie/Ways | L(mm) | H(mm) | P(mm) | € |
|--------------|---------------|----------|-------|-------|-------|--------|
| 52102230GA | 52112230GA | 2 + 2 | 850 | 750 | 110 | 692,36 |
| 52102230GB | 52112230GB | 2 + 3 | 850 | 750 | 110 | 715,89 |
| 52102230GC | 52112230GC | 2 + 4 | 850 | 750 | 110 | 739,69 |
| 52102230GD | 52112230GD | 2 + 5 | 1000 | 750 | 110 | 783,81 |
| 52102230GE | 52112230GE | 2 + 6 | 1000 | 750 | 110 | 806,40 |
| 52102230GF | 52112230GF | 2 + 7 | 1000 | 750 | 110 | 830,40 |
| 52102230GG | 52112230GG | 2 + 8 | 1200 | 750 | 110 | 874,43 |
| 52102230GH | 52112230GH | 2 + 9 | 1200 | 750 | 110 | 894,93 |
| 52102230GJ | 52112230GJ | 2 + 10 | 1200 | 750 | 110 | 918,45 |
| 52102230GK | 52112230GK | 2 + 11 | 1200 | 750 | 110 | 941,66 |
| 52102230GL | 52112230GL | 2 + 12 | 1300 | 750 | 110 | 986,46 |

Versione con circolatore a tre velocità (solo per paesi extra CEE)
Version with 3 speed pump (only for extra CEE country)
Ausführung mit 3-Gang-Pumpe (nur für Klein CEE-Land)
Version avec pompe à 3 vitesses (uniquement pour les pays extra CEE)
Версия с трехскоростным насосом (только для стран, не входящих в ЕС)

| Cod. Sx/Left | Cod. Dx/Right | Vie/Ways | L(mm) | H(mm) | P(mm) | € |
|--------------|---------------|----------|-------|-------|-------|--------|
| 52101230GA | 52111230GA | 2 + 2 | 850 | 750 | 110 | 570,83 |
| 52101230GB | 52111230GB | 2 + 3 | 850 | 750 | 110 | 594,36 |
| 52101230GC | 52111230GC | 2 + 4 | 850 | 750 | 110 | 618,16 |
| 52101230GD | 52111230GD | 2 + 5 | 1000 | 750 | 110 | 662,28 |
| 52101230GE | 52111230GE | 2 + 6 | 1000 | 750 | 110 | 684,87 |
| 52101230GF | 52111230GF | 2 + 7 | 1000 | 750 | 110 | 708,87 |
| 52101230GG | 52111230GG | 2 + 8 | 1200 | 750 | 110 | 752,90 |
| 52101230GH | 52111230GH | 2 + 9 | 1200 | 750 | 110 | 773,40 |
| 52101230GJ | 52111230GJ | 2 + 10 | 1200 | 750 | 110 | 796,92 |
| 52101230GK | 52111230GK | 2 + 11 | 1200 | 750 | 110 | 820,13 |
| 52101230GL | 52111230GL | 2 + 12 | 1300 | 750 | 110 | 864,93 |

Versione senza circolatore (con tronchetto spaziatore)
Version without pump (with pipes pre-mounted)
Ausführung ohne Pumpe (mit Balken vormontiert)
Version sans pompe (avec des tuyaux pré-monté)
Версия без насоса (с предустановленными трубами)

IVR MULTIKLIMA 516



Interasse attacco tubazioni: 150 mm.
 Pipe connection center to center: 150 mm.

Modulo di distribuzione per bassa temperatura, con separatore idraulico in acciaio inox, con collettori in acciaio inox AISI 304 da 1" x 3/4" EK, da 2 a 12 derivazioni; completi di: valvole d'intercettazione, valvole termostattizzabili, misuratori di portata, rubinetto orientabile di carico scarico, valvola sfiato aria. Gruppo di miscelazione modulante con servocomando elettrotermico, gruppo by-pass con termostato di sicurezza, detentore micrometrico e pozzetto porta sonda.

Mixing unit for low temperature with hydraulic separator, with AISI 304 stainless steel manifolds 1"x3/4" EK, 2-12 ways; fitted with: interception valves, thermostatic valves, flow meters, rotatable drain valve and air vent. Modulating mixing unit with electrothermal actuator, by-pass group with safety thermostat, micrometric lockshield and sensor connection.

Verteilermodul für niedrige Temperatur, mit hydraulischer Weiche aus rostfreiem Stahl und mit Verteilerrohren aus rostfreiem Stahl AISI 304 mit Ek Übergang 1"x3/4", mit 2-12 Abzweigungen; ausgestattet mit: Absperrventilen, thermostatisierbaren Ventilen, Durchflussmessern, drehbarem Ein-/Ablassventil und Luftablassventil. Fest eingestellte Mischerguppe mit elektrothermischer Servosteuerung, Bypass-Gruppe mit Sicherheitsthermostat, mikrometrischem Regelventil und Sondenaufnahme.

Module de distribution pour basse température avec séparateur hydraulique en acier inoxydable et avec collecteurs en acier inoxydable AISI304, de 1" x 3/4" EK, à 2-12 dérivations; pourvus de: vannes d'arrêt, vannes thermostatisables, débitmètres, robinet orientable de chargement/déchargement, vanne de purge de l'air. Groupe de mélange modulante avec servocommande électrothermique, groupe by-pass avec thermostat de sécurité, coude de réglage micrométrique, puisard porte-sonde et séparateur hydraulique en acier inoxydable.

Распределительный модуль с коллекторами и гидравлическим сепаратором из нержавеющей стали AISI 304 1" x 3/4" Евроконус, от 2 до 12 отводов для низкой температуры состоит из: шарового крана для насоса, термостатического клапана (для термостатических головок), расходомера, дренажного крана, воздушного клапана и крепления. Также входит модулирующая смешивательная группа с термоэлектрическим приводом и группой бай-пасс с предохранительным термостатом, микрометрическим отсекающим вентилем и подключением температурного зонда.

| Cod. Sx/Left | Cod. Dx/Right | Vie/Ways | L(mm) | H(mm) | P(mm) | € |
|--------------|---------------|----------|-------|-------|-------|---------|
| 51603232BA | 51613232BA | 2 | 850 | 750 | 110 | 988,56 |
| 51603232BB | 51613232BB | 3 | 850 | 750 | 110 | 1012,09 |
| 51603232BC | 51613232BC | 4 | 850 | 750 | 110 | 1035,89 |
| 51603232BD | 51613232BD | 5 | 1000 | 750 | 110 | 1080,01 |
| 51603232BE | 51613232BE | 6 | 1000 | 750 | 110 | 1102,60 |
| 51603232BF | 51613232BF | 7 | 1000 | 750 | 110 | 1126,60 |
| 51603232BG | 51613232BG | 8 | 1200 | 750 | 110 | 1170,63 |
| 51603232BH | 51613232BH | 9 | 1200 | 750 | 110 | 1191,13 |
| 51603232BJ | 51613232BJ | 10 | 1200 | 750 | 110 | 1214,65 |
| 51603232BK | 51613232BK | 11 | 1200 | 750 | 110 | 1237,86 |
| 51603232BL | 51613232BL | 12 | 1300 | 750 | 110 | 1282,66 |

Versione con circolatore volumetrico in Classe A
 Version with Class A volumetric pump
 Ausführung mit Class A Umlaufpumpe
 Version avec class A pompe volumétrique
 Версия с циркуляционным насосом класса А

| Cod. Sx/Left | Cod. Dx/Right | Vie/Ways | L(mm) | H(mm) | P(mm) | € |
|--------------|---------------|----------|-------|-------|-------|---------|
| 51602232BA | 51612232BA | 2 | 850 | 750 | 110 | 891,06 |
| 51602232BB | 51612232BB | 3 | 850 | 750 | 110 | 914,59 |
| 51602232BC | 51612232BC | 4 | 850 | 750 | 110 | 938,39 |
| 51602232BD | 51612232BD | 5 | 1000 | 750 | 110 | 982,51 |
| 51602232BE | 51612232BE | 6 | 1000 | 750 | 110 | 1005,10 |
| 51602232BF | 51612232BF | 7 | 1000 | 750 | 110 | 1029,10 |
| 51602232BG | 51612232BG | 8 | 1200 | 750 | 110 | 1073,13 |
| 51602232BH | 51612232BH | 9 | 1200 | 750 | 110 | 1093,63 |
| 51602232BJ | 51612232BJ | 10 | 1200 | 750 | 110 | 1117,15 |
| 51602232BK | 51612232BK | 11 | 1200 | 750 | 110 | 1140,36 |
| 51602232BL | 51612232BL | 12 | 1300 | 750 | 110 | 1185,16 |

Versione con circolatore a tre velocità (solo per paesi extra CEE)
 Version with 3 speed pump (only for extra CEE country)
 Ausführung mit 3-Gang-Pumpe (nur für Klein CEE-Land)
 Version avec pompe à 3 vitesses (uniquement pour les pays extra CEE)
 Версия с трехскоростным насосом (только для стран, не входящих в ЕС)

| Cod. Sx/Left | Cod. Dx/Right | Vie/Ways | L(mm) | H(mm) | P(mm) | € |
|--------------|---------------|----------|-------|-------|-------|---------|
| 51601232BA | 51611232BA | 2 | 850 | 750 | 110 | 769,53 |
| 51601232BB | 51611232BB | 3 | 850 | 750 | 110 | 793,06 |
| 51601232BC | 51611232BC | 4 | 850 | 750 | 110 | 816,86 |
| 51601232BD | 51611232BD | 5 | 1000 | 750 | 110 | 860,98 |
| 51601232BE | 51611232BE | 6 | 1000 | 750 | 110 | 883,57 |
| 51601232BF | 51611232BF | 7 | 1000 | 750 | 110 | 907,57 |
| 51601232BG | 51611232BG | 8 | 1200 | 750 | 110 | 951,60 |
| 51601232BH | 51611232BH | 9 | 1200 | 750 | 110 | 972,10 |
| 51601232BJ | 51611232BJ | 10 | 1200 | 750 | 110 | 995,62 |
| 51601232BK | 51611232BK | 11 | 1200 | 750 | 110 | 1018,83 |
| 51601232BL | 51611232BL | 12 | 1300 | 750 | 110 | 1063,63 |

Versione senza circolatore (con tronchetto spaziatore)
 Version without pump (with pipes premounted)
 Ausführung ohne Pumpe (mit Balken vormontiert)
 Version sans pompe (avec des tuyaux prémonté)
 Версия без насоса (с предустановленными трубами)

IVR MULTIKLIMA 515



Interasse attacco tubazioni: 277 mm.
Pipe connection center to center: 277 mm.

Modulo di distribuzione per bassa temperatura, con separatore idraulico in acciaio inox, con collettori in acciaio inox AISI 304 da 1" x 3/4" EK, da 2 a 12 derivazioni; completi di: valvole d'intercettazione, valvole termostattizzabili, misuratori di portata, rubinetto orientabile di carico scarico, valvola sfianto aria. Gruppo di miscelazione modulante con servocomando elettrotermico, gruppo by-pass con termostato di sicurezza, detentore micrometrico e pozzetto porta sonda.

Mixing unit for low temperature with hydraulic separator, with AISI 304 stainless steel manifolds 1"x3/4" EK, 2-12 ways; fitted with: interception valves, thermostatic valves, flow meters, rotatable drain valve and air vent. Modulating mixing unit with electrothermal actuator, by-pass group with safety thermostat, micrometric lockshield and sensor connection.

Verteilermodul für niedrige Temperatur, mit hydraulischer Weiche aus rostfreiem Stahl und mit Verteilerrohren aus rostfreiem Stahl AISI 304 mit Ek Übergang 1"x3/4", mit 2-12 Abzweigungen; ausgestattet mit: Absperrventilen, thermostatisierbaren Ventilen, Durchflussmessern, drehbarem Ein-/Ablassventil und Luftablassventil. Fest eingestellte Mischerguppe mit elektrothermischer Servosteuerung, Bypass-Gruppe mit Sicherheitsthermostat, mikrometrischem Regelventil und Sondenaufnahme.

Module de distribution pour basse température avec séparateur hydraulique en acier inoxydable et avec collecteurs en acier inoxydable AISI304, de 1" x 3/4" EK, à 2-12 dérivation; pourvus de: vannes d'arrêt, vannes thermostatisables, débitmètres, robinet orientable de chargement/déchargement, vanne de purge de l'air. Groupe de mélange modulante avec servocommande électrothermique, groupe by-pass avec thermostat de sécurité, coude de réglage micrométrique, puisard porte-sonde et séparateur hydraulique en acier inoxydable.

Распределительный модуль с коллекторами и гидравлическим сепаратором из нержавеющей стали AISI 304 1" x 3/4" Евроконус, от 2 до 12 отводов для низкой температуры состоит из: шарового крана для насоса, термостатического клапана (для термостатических головок), расходомера, дренажного крана, воздушного клапана и крепления. Также входит модулирующая смешивающая группа с термозлектрическим приводом и группой бай-пасс с предохранительным термостатом, микрометрическим отсекающим вентилем и подключением температурного зонда.

| Cod. Sx/Left | Cod. Dx/Right | Vie/Ways | L(mm) | H(mm) | P(mm) | € |
|--------------|---------------|----------|-------|-------|-------|---------|
| 51503232BA | 51513232BA | 2 | 600 | 750 | 110 | 784,23 |
| 51503232BB | 51513232BB | 3 | 700 | 750 | 110 | 815,79 |
| 51503232BC | 51513232BC | 4 | 700 | 750 | 110 | 839,59 |
| 51503232BD | 51513232BD | 5 | 850 | 750 | 110 | 873,66 |
| 51503232BE | 51513232BE | 6 | 850 | 750 | 110 | 896,25 |
| 51503232BF | 51513232BF | 7 | 850 | 750 | 110 | 920,24 |
| 51503232BG | 51513232BG | 8 | 1000 | 750 | 110 | 964,32 |
| 51503232BH | 51513232BH | 9 | 1000 | 750 | 110 | 984,81 |
| 51503232BJ | 51513232BJ | 10 | 1000 | 750 | 110 | 1008,34 |
| 51503232BK | 51513232BK | 11 | 1200 | 750 | 110 | 1051,31 |
| 51503232BL | 51513232BL | 12 | 1200 | 750 | 110 | 1074,32 |

Versione con circolatore volumetrico in Classe A
Version with Class A volumetric pump
Ausführung mit Class A Umlaufpumpe
Version avec class A pompe volumétrique
Версия с циркуляционным насосом класса А

| Cod. Sx/Left | Cod. Dx/Right | Vie/Ways | L(mm) | H(mm) | P(mm) | € |
|--------------|---------------|----------|-------|-------|-------|--------|
| 51502232BA | 51512232BA | 2 | 600 | 750 | 110 | 686,73 |
| 51502232BB | 51512232BB | 3 | 700 | 750 | 110 | 718,29 |
| 51502232BC | 51512232BC | 4 | 700 | 750 | 110 | 742,09 |
| 51502232BD | 51512232BD | 5 | 850 | 750 | 110 | 776,16 |
| 51502232BE | 51512232BE | 6 | 850 | 750 | 110 | 798,75 |
| 51502232BF | 51512232BF | 7 | 850 | 750 | 110 | 822,74 |
| 51502232BG | 51512232BG | 8 | 1000 | 750 | 110 | 866,82 |
| 51502232BH | 51512232BH | 9 | 1000 | 750 | 110 | 887,31 |
| 51502232BJ | 51512232BJ | 10 | 1000 | 750 | 110 | 910,84 |
| 51502232BK | 51512232BK | 11 | 1200 | 750 | 110 | 953,81 |
| 51502232BL | 51512232BL | 12 | 1200 | 750 | 110 | 976,82 |

Versione con circolatore a tre velocità (solo per paesi extra CEE)
Version with 3 speed pump (only for extra CEE country)
Ausführung mit 3-Gang-Pumpe (nur für Klein CEE-Land)
Version avec pompe à 3 vitesses (uniquement pour les pays extra CEE)
Версия с трехскоростным насосом (только для стран, не входящих в ЕС)

| Cod. Sx/Left | Cod. Dx/Right | Vie/Ways | L(mm) | H(mm) | P(mm) | € |
|--------------|---------------|----------|-------|-------|-------|--------|
| 51501232BA | 51511232BA | 2 | 600 | 750 | 110 | 565,20 |
| 51501232BB | 51511232BB | 3 | 700 | 750 | 110 | 596,76 |
| 51501232BC | 51511232BC | 4 | 700 | 750 | 110 | 620,56 |
| 51501232BD | 51511232BD | 5 | 850 | 750 | 110 | 654,63 |
| 51501232BE | 51511232BE | 6 | 850 | 750 | 110 | 677,22 |
| 51501232BF | 51511232BF | 7 | 850 | 750 | 110 | 701,21 |
| 51501232BG | 51511232BG | 8 | 1000 | 750 | 110 | 745,29 |
| 51501232BH | 51511232BH | 9 | 1000 | 750 | 110 | 765,78 |
| 51501232BJ | 51511232BJ | 10 | 1000 | 750 | 110 | 789,31 |
| 51501232BK | 51511232BK | 11 | 1200 | 750 | 110 | 832,28 |
| 51501232BL | 51511232BL | 12 | 1200 | 750 | 110 | 855,29 |

Versione senza circolatore (con tronchetto spaziatore)
Version without pump (with pipes pre-mounted)
Ausführung ohne Pumpe (mit Balken vormontiert)
Version sans pompe (avec des tuyaux pré-monté)
Версия без насоса (с предустановленными трубами)

IVR MULTIKLIMA 514



Interasse attacco tubazioni: 150 mm.
 Pipe connection center to center: 150 mm.

Modulo di distribuzione per bassa temperatura, con separatore idraulico in acciaio inox, con collettori in acciaio inox AISI 304 da 1" x 3/4" EK, da 2 a 12 derivazioni; completi di: valvola d'intercettazione, valvole termostattizzabili, misuratori di portata, rubinetto orientabile di carico scarico, valvola sfiato aria. Gruppo di miscelazione a punto fisso con miscelatore termostatico, gruppo by-pass con termostato di sicurezza, detentore micrometrico e pozzetto porta sonda.

Water distribution cabinet for low temperature with stainless steel hydraulic separator and with AISI 304 stainless steel manifolds 1"x3/4" EK, 2-12 ways; fitted with: interception valve, thermostatic valves, flow meters, rotatable drain valves and air vent. Mixing unit with fixed point with thermostatic mixing valve, by-pass group with safety thermostat, micrometric lockshield and sensor connection.

Verteilermodule für niedrige Temperatur mit hydraulischer Weiche aus rostfreiem Stahl und mit Verteilerrohren aus rostfreiem Stahl AISI 304 mit Ek Übergang 1"x3/4", mit 2-12 Abzweigungen; ausgestattet mit: Absperrventil, thermostatisierbaren Ventilen, Durchflussmessern, drehbarem Ein-/Ablassventil und Luftablassventil. Fest eingestellte Mischerguppe mit thermostatischem Mischer, Bypass-Gruppe mit Sicherheitsthermostat, mikrometrischem Regelventil und Sondenaufnahme.

Module de distribution pour basse température, avec collecteurs en acier inoxydable AISI304, de 1" x 3/4" EK, à 2-12 dérivation; pourvus de: vanne d'arrêt, vannes thermostatisables, débitmètres, robinet orientable de chargement/déchargement, vanne de purge de l'air. Groupe de mélange à point fixe avec mitigeur thermostatique, groupe by-pass avec thermostat de sécurité, coude de réglage micrométrique et puisard porte-sonde, séparateur hydraulique en acier inoxydable et séparateur hydraulique en acier inoxydable.

Распределительный модуль с коллекторами и гидравлическим сепаратором из нержавеющей стали AISI 304 1" x 3/4" Евроконус, от 2 до 12 отводов для низкой температуры состоит из: шарового крана для насоса, терmostатического клапана (для терmostатических головок), расходомера, дренажного крана, воздушного клапана и крепления. Также входит модулирующая смешительная группа с терmostатическим вентилем и группой бай-пасс с предохранительным терmostатом, микрометрическим отсекающим вентилем и подключением температурного зонда.

| Cod. Sx/Left | Cod. Dx/Right | Vie/Ways | L(mm) | H(mm) | P(mm) | € |
|--------------|---------------|----------|-------|-------|-------|---------|
| 51403231BA | 51413231BA | 2 | 850 | 750 | 110 | 1010,23 |
| 51403231BB | 51413231BB | 3 | 850 | 750 | 110 | 1033,76 |
| 51403231BC | 51413231BC | 4 | 850 | 750 | 110 | 1057,56 |
| 51403231BD | 51413231BD | 5 | 1000 | 750 | 110 | 1101,68 |
| 51403231BE | 51413231BE | 6 | 1000 | 750 | 110 | 1124,27 |
| 51403231BF | 51413231BF | 7 | 1000 | 750 | 110 | 1148,27 |
| 51403231BG | 51413231BG | 8 | 1200 | 750 | 110 | 1192,30 |
| 51403231BH | 51413231BH | 9 | 1200 | 750 | 110 | 1212,80 |
| 51403231BJ | 51413231BJ | 10 | 1200 | 750 | 110 | 1236,32 |
| 51403231BK | 51413231BK | 11 | 1200 | 750 | 110 | 1259,53 |
| 51403231BL | 51413231BL | 12 | 1300 | 750 | 110 | 1304,33 |

Versione con circolatore volumetrico in Classe A
 Version with Class A volumetric pump
 Ausführung mit Class A Umlaufpumpe
 Version avec class A pompe volumétrique
 Версия с циркуляционным насосом класса A

| Cod. Sx/Left | Cod. Dx/Right | Vie/Ways | L(mm) | H(mm) | P(mm) | € |
|--------------|---------------|----------|-------|-------|-------|---------|
| 51402231BA | 51412231BA | 2 | 850 | 750 | 110 | 908,90 |
| 51402231BB | 51412231BB | 3 | 850 | 750 | 110 | 932,43 |
| 51402231BC | 51412231BC | 4 | 850 | 750 | 110 | 956,23 |
| 51402231BD | 51412231BD | 5 | 1000 | 750 | 110 | 1000,35 |
| 51402231BE | 51412231BE | 6 | 1000 | 750 | 110 | 1022,94 |
| 51402231BF | 51412231BF | 7 | 1000 | 750 | 110 | 1046,94 |
| 51402231BG | 51412231BG | 8 | 1200 | 750 | 110 | 1090,97 |
| 51402231BH | 51412231BH | 9 | 1200 | 750 | 110 | 1111,47 |
| 51402231BJ | 51412231BJ | 10 | 1200 | 750 | 110 | 1134,99 |
| 51402231BK | 51412231BK | 11 | 1200 | 750 | 110 | 1158,20 |
| 51402231BL | 51412231BL | 12 | 1300 | 750 | 110 | 1203,00 |

Versione con circolatore a tre velocità (solo per paesi extra CEE)
 Version with 3 speed pump (only for extra CEE country)
 Ausführung mit 3-Gang-Pumpe (nur für Klein CEE-Land)
 Version avec pompe à 3 vitesses (uniquement pour les pays extra CEE)
 Версия с трехскоростным насосом (только для стран, не входящих в ЕС)

| Cod. Sx/Left | Cod. Dx/Right | Vie/Ways | L(mm) | H(mm) | P(mm) | € |
|--------------|---------------|----------|-------|-------|-------|---------|
| 51401231BA | 51411231BA | 2 | 850 | 750 | 110 | 787,37 |
| 51401231BB | 51411231BB | 3 | 850 | 750 | 110 | 810,90 |
| 51401231BC | 51411231BC | 4 | 850 | 750 | 110 | 834,70 |
| 51401231BD | 51411231BD | 5 | 1000 | 750 | 110 | 878,82 |
| 51401231BE | 51411231BE | 6 | 1000 | 750 | 110 | 901,41 |
| 51401231BF | 51411231BF | 7 | 1000 | 750 | 110 | 925,41 |
| 51401231BG | 51411231BG | 8 | 1200 | 750 | 110 | 969,44 |
| 51401231BH | 51411231BH | 9 | 1200 | 750 | 110 | 989,94 |
| 51401231BJ | 51411231BJ | 10 | 1200 | 750 | 110 | 1013,46 |
| 51401231BK | 51411231BK | 11 | 1200 | 750 | 110 | 1036,67 |
| 51401231BL | 51411231BL | 12 | 1300 | 750 | 110 | 1081,47 |

Versione senza circolatore (con tronchetto spaziatore)
 Version without pump (with pipes pre-mounted)
 Ausführung ohne Pumpe (mit Balken vormontiert)
 Version sans pompe (avec des tuyaux prémonté)
 Версия без насоса (с предустановленными трубами)

IVR MULTIKLIMA 513



Interasse attacco tubazioni: 277 mm.
Pipe connection center to center: 277 mm.

Modulo di distribuzione per bassa temperatura con collettori in acciaio inox AISI 304 da 1" x 3/4" EK, da 2 a 12 derivazioni; completi di: valvola d'intercettazione, valvole termostattizzabili, misuratori di portata, rubinetto orientabile di carico scarico, valvola sfiato aria. Gruppo di miscelazione a punto fisso con miscelatore termostatico, gruppo by-pass con termostato di sicurezza, detentore micrometrico e pozzetto porta sonda.

Water distribution cabinet for low temperature with AISI 304 stainless steel manifolds 1"x3/4" EK, 2-12 ways; fitted with: interception valve, thermostatic valves, flow meters, rotatable drain valves and air vent. Mixing unit with fixed point with thermostatic mixing valve, by-pass group with safety thermostat, micrometric lockshield and sensor connection.

Verteilermodul für niedrige Temperatur mit Verteilerrohren aus rostfreiem Stahl AISI 304 mit Ek Übergang 1"x3/4", mit 2-12 Abzweigungen; ausgestattet mit: Absperrventil, thermostatisierbaren Ventilen, Durchflussmessern, drehbarem Ein-/Ablassventil und Luftablassventil. Fest eingestellte Mischerguppe mit Thermostatmischer, Bypass-Gruppe mit Sicherheitsthermostat, mikrometrischem Regelventil und Sondenaufnahme.

Module de distribution pour basse température, avec collecteurs en acier inoxydable AISI304, de 1" x 3/4" EK, à 2-12 dérivation; pourvus de: vanne d'arrêt, vannes thermostatisables, débitmètres, robinet orientable de chargement/déchargement, vanne de purge de l'air. Groupe de mélange à point fixe avec mélangeur thermostatique, groupe by-pass avec thermostat de sécurité, coude de réglage micrométrique et puisard porte-sonde.

Распределительный модуль с коллекторами из нержавеющей стали AISI 304 1" x 3/4" Евроконус, от 2 до 12 отводов для низкой температуры состоит из: шарового крана для насоса, термостатического клапана (для термостатических головок), расходомера, дренажного крана, воздушного клапана и крепления. Также входит модулирующая смесительная группа с термостатическим вентилем и группой бай-пасс с предохранительным термостатом, микрометрическим отсекающим вентилем и подключением температурного зонда.

| Cod. Sx/Left | Cod. Dx/Right | Vie/Ways | L(mm) | H(mm) | P(mm) | € |
|--------------|---------------|----------|-------|-------|-------|---------|
| 51303231BA | 51313231BA | 2 | 600 | 750 | 110 | 805,90 |
| 51303231BB | 51313231BB | 3 | 700 | 750 | 110 | 837,46 |
| 51303231BC | 51313231BC | 4 | 700 | 750 | 110 | 861,26 |
| 51303231BD | 51313231BD | 5 | 850 | 750 | 110 | 895,33 |
| 51303231BE | 51313231BE | 6 | 850 | 750 | 110 | 917,92 |
| 51303231BF | 51313231BF | 7 | 850 | 750 | 110 | 941,92 |
| 51303231BG | 51313231BG | 8 | 1000 | 750 | 110 | 985,99 |
| 51303231BH | 51313231BH | 9 | 1000 | 750 | 110 | 1006,48 |
| 51303231BJ | 51313231BJ | 10 | 1000 | 750 | 110 | 1030,01 |
| 51303231BK | 51313231BK | 11 | 1200 | 750 | 110 | 1072,98 |
| 51303231BL | 51313231BL | 12 | 1200 | 750 | 110 | 1095,99 |

Versione con circolatore volumetrico in Classe A
Version with Class A volumetric pump
Ausführung mit Class A Umlaufpumpe
Version avec class A pompe volumétrique
Версия с циркуляционным насосом класса А

| Cod. Sx/Left | Cod. Dx/Right | Vie/Ways | L(mm) | H(mm) | P(mm) | € |
|--------------|---------------|----------|-------|-------|-------|--------|
| 51302231BA | 51312231BA | 2 | 600 | 750 | 110 | 704,57 |
| 51302231BB | 51312231BB | 3 | 700 | 750 | 110 | 736,13 |
| 51302231BC | 51312231BC | 4 | 700 | 750 | 110 | 759,93 |
| 51302231BD | 51312231BD | 5 | 850 | 750 | 110 | 794,00 |
| 51302231BE | 51312231BE | 6 | 850 | 750 | 110 | 816,59 |
| 51302231BF | 51312231BF | 7 | 850 | 750 | 110 | 840,58 |
| 51302231BG | 51312231BG | 8 | 1000 | 750 | 110 | 884,65 |
| 51302231BH | 51312231BH | 9 | 1000 | 750 | 110 | 905,15 |
| 51302231BJ | 51312231BJ | 10 | 1000 | 750 | 110 | 928,67 |
| 51302231BK | 51312231BK | 11 | 1200 | 750 | 110 | 971,64 |
| 51302231BL | 51312231BL | 12 | 1200 | 750 | 110 | 994,66 |

Versione con circolatore a tre velocità (solo per paesi extra CEE)
Version with 3 speed pump (only for extra CEE country)
Ausführung mit 3-Gang-Pumpe (nur für Klein CEE-Land)
Version avec pompe à 3 vitesses (uniquement pour les pays extra CEE)
Версия с трехскоростным насосом (только для стран, не входящих в ЕС)

| Cod. Sx/Left | Cod. Dx/Right | Vie/Ways | L(mm) | H(mm) | P(mm) | € |
|--------------|---------------|----------|-------|-------|-------|--------|
| 51301231BA | 51311231BA | 2 | 600 | 750 | 110 | 583,04 |
| 51301231BB | 51311231BB | 3 | 700 | 750 | 110 | 614,60 |
| 51301231BC | 51311231BC | 4 | 700 | 750 | 110 | 638,40 |
| 51301231BD | 51311231BD | 5 | 850 | 750 | 110 | 672,47 |
| 51301231BE | 51311231BE | 6 | 850 | 750 | 110 | 695,06 |
| 51301231BF | 51311231BF | 7 | 850 | 750 | 110 | 719,05 |
| 51301231BG | 51311231BG | 8 | 1000 | 750 | 110 | 763,12 |
| 51301231BH | 51311231BH | 9 | 1000 | 750 | 110 | 783,62 |
| 51301231BJ | 51311231BJ | 10 | 1000 | 750 | 110 | 807,14 |
| 51301231BK | 51311231BK | 11 | 1200 | 750 | 110 | 850,11 |
| 51301231BL | 51311231BL | 12 | 1200 | 750 | 110 | 873,13 |

Versione senza circolatore (con tronchetto spaziatore)
Version without pump (with pipes pre-mounted)
Ausführung ohne Pumpe (mit Balken vormontiert)
Version sans pompe (avec des tuyaux pré-monté)
Версия без насоса (с предустановленными трубами)

IVR MULTIKLIMA 512



Interasse attacco tubazioni: 150 mm.
Pipe connection center to center: 150 mm.

Modulo di distribuzione per bassa temperatura, con separatore idraulico in acciaio inox, con collettori in acciaio inox AISI 304 da 1" x 3/4" EK, da 2 a 12 derivazioni; completi di: valvola d'intercettazione, valvole termostattizzabili, misuratori di portata, rubinetto orientabile di carico scarico, valvola sfiato aria. Gruppo di miscelazione a punto fisso con testa termostatica, gruppo by-pass con termostato di sicurezza, detentore micrometrico e pozzetto porta sonda.

Water distribution cabinet for low temperature with stainless steel hydraulic separator and with AISI 304 stainless steel manifolds 1"x3/4" EK, 2-12 ways; fitted with: interception valve, thermostatic valves, flow meters, rotatable drain valves and air vent. Mixing unit with fixed point with thermostatic head, by-pass group with safety thermostat, micrometric lockshield and sensor connection.

Verteilermodul für niedrige Temperatur, mit hydraulischer Weiche aus rostfreiem Stahl und mit Verteilerrohren aus rostfreiem Stahl AISI 304 mit Ek Übergang 1"x3/4", mit 2-12 Abzweigungen; ausgestattet mit: Absperrventil, thermostatisierbaren Ventilen, Durchflussmessern, drehbarem Ein-/Ablassventil und Luftablassventil. Fest eingestellte Mischerguppe mit thermostatischem Kopf, Bypass-Gruppe mit Sicherheitsthermostat, mikrometrischem Regelventil und Sondenaufnahme.

Module de distribution pour basse température, avec séparateur hydraulique en acier inoxydable et avec collecteurs en acier inoxydable AISI304, de 1" x 3/4" EK, à 2-12 dérivation; pourvus de: vannes d'arrêt, vanne thermostatisables, débitmètres, robinet orientable de chargement/déchargement, vanne de purge de l'air. Groupe de mélange à point fixe avec tête thermostatique, groupe by-pass avec thermostat de sécurité, coude de réglage micrométrique puisard porte-sonde.

Распределительный модуль с коллекторами и гидравлическим сепаратором из нержавеющей стали AISI 304 1" x 3/4" Евроконус, от 2 до 12 отводов для низкой температуры состоит из: шарового крана для насоса, термостатического клапана (для термостатических головок), расходомера, дренажного крана, воздушного клапана и крепления. Также входит модулирующая смесительная группа с термостатической головкой и группой бай-пасс с предохранительным термостатом, микрометрическим отсекающим вентилем и подключением температурного зонда.

| Cod. Sx/Left | Cod. Dx/Right | Vie/Ways | L(mm) | H(mm) | P(mm) | € |
|--------------|---------------|----------|-------|-------|-------|---------|
| 51203230BA | 51213230BA | 2 | 850 | 750 | 110 | 908,39 |
| 51203230BB | 51213230BB | 3 | 850 | 750 | 110 | 931,92 |
| 51203230BC | 51213230BC | 4 | 850 | 750 | 110 | 955,72 |
| 51203230BD | 51213230BD | 5 | 1000 | 750 | 110 | 999,84 |
| 51203230BE | 51213230BE | 6 | 1000 | 750 | 110 | 1022,43 |
| 51203230BF | 51213230BF | 7 | 1000 | 750 | 110 | 1046,43 |
| 51203230BG | 51213230BG | 8 | 1200 | 750 | 110 | 1090,46 |
| 51203230BH | 51213230BH | 9 | 1200 | 750 | 110 | 1110,96 |
| 51203230BJ | 51213230BJ | 10 | 1200 | 750 | 110 | 1134,48 |
| 51203230BK | 51213230BK | 11 | 1200 | 750 | 110 | 1157,69 |
| 51203230BL | 51213230BL | 12 | 1300 | 750 | 110 | 1202,49 |

Versione con circolatore volumetrico in Classe A
Version with Class A volumetric pump
Ausführung mit Class A Umlaufpumpe
Version avec class A pompe volumétrique
Версия с циркуляционным насосом класса А

| Cod. Sx/Left | Cod. Dx/Right | Vie/Ways | L(mm) | H(mm) | P(mm) | € |
|--------------|---------------|----------|-------|-------|-------|---------|
| 51202230BA | 51212230BA | 2 | 850 | 750 | 110 | 810,89 |
| 51202230BB | 51212230BB | 3 | 850 | 750 | 110 | 834,42 |
| 51202230BC | 51212230BC | 4 | 850 | 750 | 110 | 858,22 |
| 51202230BD | 51212230BD | 5 | 1000 | 750 | 110 | 902,34 |
| 51202230BE | 51212230BE | 6 | 1000 | 750 | 110 | 924,93 |
| 51202230BF | 51212230BF | 7 | 1000 | 750 | 110 | 948,93 |
| 51202230BG | 51212230BG | 8 | 1200 | 750 | 110 | 992,96 |
| 51202230BH | 51212230BH | 9 | 1200 | 750 | 110 | 1013,46 |
| 51202230BJ | 51212230BJ | 10 | 1200 | 750 | 110 | 1036,98 |
| 51202230BK | 51212230BK | 11 | 1200 | 750 | 110 | 1060,19 |
| 51202230BL | 51212230BL | 12 | 1300 | 750 | 110 | 1104,99 |

Versione con circolatore a tre velocità (solo per paesi extra CEE)
Version with 3 speed pump (only for extra CEE country)
Ausführung mit 3-Gang-Pumpe (nur für Klein CEE-Land)
Version avec pompe à 3 vitesses (uniquement pour les pays extra CEE)
Версия с трехскоростным насосом (только для стран, не входящих в ЕС)

| Cod. Sx/Left | Cod. Dx/Right | Vie/Ways | L(mm) | H(mm) | P(mm) | € |
|--------------|---------------|----------|-------|-------|-------|--------|
| 51201230BA | 51211230BA | 2 | 850 | 750 | 110 | 690,09 |
| 51201230BB | 51211230BB | 3 | 850 | 750 | 110 | 713,62 |
| 51201230BC | 51211230BC | 4 | 850 | 750 | 110 | 737,42 |
| 51201230BD | 51211230BD | 5 | 1000 | 750 | 110 | 781,54 |
| 51201230BE | 51211230BE | 6 | 1000 | 750 | 110 | 804,13 |
| 51201230BF | 51211230BF | 7 | 1000 | 750 | 110 | 828,13 |
| 51201230BG | 51211230BG | 8 | 1200 | 750 | 110 | 872,16 |
| 51201230BH | 51211230BH | 9 | 1200 | 750 | 110 | 892,66 |
| 51201230BJ | 51211230BJ | 10 | 1200 | 750 | 110 | 916,18 |
| 51201230BK | 51211230BK | 11 | 1200 | 750 | 110 | 939,39 |
| 51201230BL | 51211230BL | 12 | 1300 | 750 | 110 | 984,19 |

Versione senza circolatore (con tronchetto spaziatore)
Version without pump (with pipes pre-mounted)
Ausführung ohne Pumpe (mit Balken vormontiert)
Version sans pompe (avec des tuyaux pré-montés)
Версия без насоса (с предустановленными трубами)

IVR MULTIKLIMA 511



Interasse attacco tubazioni: 277 mm.
Pipe connection center to center: 277 mm.

Modulo di distribuzione per bassa temperatura con collettori in acciaio inox AISI 304 da 1" x 3/4" EK, da 2 a 12 derivazioni; completi di: valvola d'intercettazione, valvole termostattizzabili, misuratori di portata, rubinetto orientabile di carico scarico, valvola sfiato aria. Gruppo di miscelazione a punto fisso con testa termostatica, gruppo by-pass con termostato di sicurezza, detentore micrometrico e pozzetto porta sonda.

Water distribution cabinet for low temperature with AISI 304 stainless steel manifolds 1"x3/4" EK, 2-12 ways; fitted with: interception valve, thermostatic valves, flow meters, rotatable drain valves and air vent. Mixing unit with fixed point with thermostatic head, by-pass group with safety thermostat, micrometric lockshield and sensor connection.

Verteilermodul für niedrige Temperatur mit Verteilerrohren aus rostfreiem Stahl AISI 304 mit Ek Übergang 1"x3/4", mit 2-12 Abzweigungen; ausgestattet mit: Absperrventilen, thermostatisierbaren Ventilen, Durchflussmessern, drehbarem Ein-/Ablassventil und Luftablassventil. Fest eingestellte Mischerguppe mit thermostatischem Kopf, Bypass-Gruppe mit Sicherheitsthermostat, mikrometrischem Regelventil und Sondenaufnahme.

Module de distribution pour basse température, avec collecteurs en acier inoxydable AISI304 de 1" x 3/4" EK, à 2-12 dérivation; pourvus de: vannes d'arrêt, vannes thermostatisables, débitmètres, robinet orientable de chargement/déchargement, vanne de purge de l'air. Groupe de mélange à point fixe avec tête thermostatique, groupe by-pass avec thermostat de sécurité, coude de réglage micrométrique et pousard porte-sonde.

Распределительный модуль с коллекторами из нержавеющей стали AISI 304 1" x 3/4" Евроконус, от 2 до 12 отводов для низкой температуры состоит из: шарового крана для насоса, термостатического клапана (для термостатических головок), расходомера, дренажного крана, воздушного клапана и крепления. Также входит модулирующая смесительная группа с термостатической головкой и группой бай-пасс с предохранительным термостатом, микрометрическим отсекающим вентилем и подключением температурного зонда.

| Cod. Sx/Left | Cod. Dx/Right | Vie/Ways | L(mm) | H(mm) | P(mm) | € |
|--------------|---------------|----------|-------|-------|-------|--------|
| 51103230BA | 51113230BA | 2 | 600 | 750 | 110 | 704,06 |
| 51103230BB | 51113230BB | 3 | 700 | 750 | 110 | 735,62 |
| 51103230BC | 51113230BC | 4 | 700 | 750 | 110 | 759,42 |
| 51103230BD | 51113230BD | 5 | 850 | 750 | 110 | 793,49 |
| 51103230BE | 51113230BE | 6 | 850 | 750 | 110 | 816,08 |
| 51103230BF | 51113230BF | 7 | 850 | 750 | 110 | 840,07 |
| 51103230BG | 51113230BG | 8 | 1000 | 750 | 110 | 884,14 |
| 51103230BH | 51113230BH | 9 | 1000 | 750 | 110 | 904,64 |
| 51103230BJ | 51113230BJ | 10 | 1000 | 750 | 110 | 928,16 |
| 51103230BK | 51113230BK | 11 | 1200 | 750 | 110 | 971,13 |
| 51103230BL | 51113230BL | 12 | 1200 | 750 | 110 | 994,15 |

Versione con circolatore volumetrico in Classe A
Version with Class A volumetric pump
Ausführung mit Class A Umlaufpumpe
Version avec class A pompe volumétrique
Версия с циркуляционным насосом класса А

| Cod. Sx/Left | Cod. Dx/Right | Vie/Ways | L(mm) | H(mm) | P(mm) | € |
|--------------|---------------|----------|-------|-------|-------|--------|
| 51102230BA | 51112230BA | 2 | 600 | 750 | 110 | 606,56 |
| 51102230BB | 51112230BB | 3 | 700 | 750 | 110 | 638,12 |
| 51102230BC | 51112230BC | 4 | 700 | 750 | 110 | 661,92 |
| 51102230BD | 51112230BD | 5 | 850 | 750 | 110 | 695,99 |
| 51102230BE | 51112230BE | 6 | 850 | 750 | 110 | 718,58 |
| 51102230BF | 51112230BF | 7 | 850 | 750 | 110 | 742,57 |
| 51102230BG | 51112230BG | 8 | 1000 | 750 | 110 | 786,64 |
| 51102230BH | 51112230BH | 9 | 1000 | 750 | 110 | 807,14 |
| 51102230BJ | 51112230BJ | 10 | 1000 | 750 | 110 | 830,66 |
| 51102230BK | 51112230BK | 11 | 1200 | 750 | 110 | 873,63 |
| 51102230BL | 51112230BL | 12 | 1200 | 750 | 110 | 896,65 |

Versione con circolatore a tre velocità (solo per paesi extra CEE)
Version with 3 speed pump (only for extra CEE country)
Ausführung mit 3-Gang-Pumpe (nur für Klein CEE-Land)
Version avec pompe à 3 vitesses (uniquement pour les pays extra CEE)
Версия с трехскоростным насосом (только для стран, не входящих в ЕС)

| Cod. Sx/Left | Cod. Dx/Right | Vie/Ways | L(mm) | H(mm) | P(mm) | € |
|--------------|---------------|----------|-------|-------|-------|--------|
| 51101230BA | 51111230BA | 2 | 600 | 750 | 110 | 485,76 |
| 51101230BB | 51111230BB | 3 | 700 | 750 | 110 | 517,32 |
| 51101230BC | 51111230BC | 4 | 700 | 750 | 110 | 541,12 |
| 51101230BD | 51111230BD | 5 | 850 | 750 | 110 | 575,19 |
| 51101230BE | 51111230BE | 6 | 850 | 750 | 110 | 597,78 |
| 51101230BF | 51111230BF | 7 | 850 | 750 | 110 | 621,77 |
| 51101230BG | 51111230BG | 8 | 1000 | 750 | 110 | 665,84 |
| 51101230BH | 51111230BH | 9 | 1000 | 750 | 110 | 686,34 |
| 51101230BJ | 51111230BJ | 10 | 1000 | 750 | 110 | 709,86 |
| 51101230BK | 51111230BK | 11 | 1200 | 750 | 110 | 752,83 |
| 51101230BL | 51111230BL | 12 | 1200 | 750 | 110 | 775,85 |

Versione senza circolatore (con tronchetto spaziatore)
Version without pump (with pipes pre-mounted)
Ausführung ohne Pumpe (mit Balken vormontiert)
Version sans pompe (avec des tuyaux pré-monté)
Версия без насоса (с предустановленными трубами)

IVR MULTIKLIMA 509/A



Interasse attacco tubazioni: 200 mm.
 Pipe connection center hole distance: 200 mm.
 Abstand des Rohranschlusses: 200 mm.
 Entraxe des fixations: 200 mm.
 Межосевое соединение : 200 мм.

Modulo di distribuzione con collettori in acciaio inox AISI 304 da 1" x 3/4" EK. Preassemblato in cassetta metallica verniciata RAL 9010, collettori completi di valvole termostattizzabili (per testa termoelettrica), rubinetto orientabile di carico scarico, valvola sfiato aria, valvole a sfera d'intercettazione, tappi e zanche. Versione con detentori micrometrici di regolazione

Water distribution cabinet includes: AISI 304 stainless steel manifolds 1" x 3/4" EK. Pre-assembled in RAL9010 plated metal cabinet, manifolds are fitted with thermostatic valves (for thermoelectric head), rotatable fill & drain valve, air vent, interception valves, caps and mounting brackets. Version with micrometric regulating lockshield

Verteilermodul mit Verteilern aus rostfreiem Stahl AISI 304 mit EK Übergang 1"x3/4". Vormontiert in einem lackiertem Metallkasten RAL 9010, Verteiler ausgestattet mit: thermostatisierbaren Ventilen (für den thermoelektrischen Kopf), dreheinstellbarem Füll- und Entleerungshahn, Luftablassventil, Absperrkugelhähnen, Kappen und Befestigungsklammern. Ausführung mit mikrometrisches Absperrventil zur Einstellung

Module de distribution avec collecteurs en acier inoxydable AISI 304, 1"x3/4" EK. Préassemblé dans un boîtier métallique verni RAL 9010, collecteurs pourvus de vanne thermostatissables (pour la tête thermoelectrique), robinet orientable de chargement/déchargement, vanne de purge de l'air, vannes d'arrêt, bouchons et plaque d'ancrage. Version avec coudes de réglages micrométriques de réglage

Распределительный модуль с коллекторами из нержавеющей стали AISI 304 1" x 3/4" Евроконус. Собранный коллекторный модуль вмонтирован в металлический шкаф, окрашенный RAL 9010. Состоит из: термостатических клапанов(для термостатических головок), дренажного клапана, воздушного клапана, шаровых кранов, заглушек и креплений. Данная версия с отсекающими микрометрическими клапанами.

| Cod. Sx/Left | Cod. Dx/Right | Vie/Ways | L(mm) | H(mm) | P(mm) | € |
|--------------|---------------|----------|-------|-------|-------|--------|
| 50900200AA | 50910200AA | 2 | 400 | 630 | 90 | 220,67 |
| 50900200AB | 50910200AB | 3 | 500 | 630 | 90 | 245,00 |
| 50900200AC | 50910200AC | 4 | 500 | 630 | 90 | 263,18 |
| 50900200AD | 50910200AD | 5 | 600 | 630 | 90 | 294,47 |
| 50900200AE | 50910200AE | 6 | 600 | 630 | 90 | 312,53 |
| 50900200AF | 50910200AF | 7 | 700 | 630 | 90 | 338,99 |
| 50900200AG | 50910200AG | 8 | 700 | 630 | 90 | 357,21 |
| 50900200AH | 50910200AH | 9 | 850 | 630 | 90 | 397,35 |
| 50900200AJ | 50910200AJ | 10 | 850 | 630 | 90 | 415,27 |
| 50900200AK | 50910200AK | 11 | 850 | 630 | 90 | 433,26 |
| 50900200AL | 50910200AL | 12 | 1000 | 630 | 90 | 470,82 |

IVR MULTIKLIMA 509/B



Interasse attacco tubazioni: 200 mm.
 Pipe connection center hole distance: 200 mm.
 Abstand des Rohranschlusses: 200 mm.
 Entraxe des fixations: 200 mm.
 Межосевое соединение : 200 мм.

Modulo di distribuzione con collettori in acciaio inox AISI 304 da 1" x 3/4" EK. Preassemblato in cassetta metallica verniciata RAL 9010, collettori completi di valvole termostattizzabili (per testa termoelettrica), rubinetto orientabile di carico scarico, valvola sfiato aria, valvole a sfera d'intercettazione, tappi e zanche. Versione con misuratori di portata

Water distribution cabinet includes: AISI 304 stainless steel manifolds 1" x 3/4" EK. Pre-assembled in RAL9010 plated metal cabinet, manifolds are fitted with thermostatic valves (for thermoelectric head), rotatable fill & drain valve, air vent, interception valves, caps and mounting brackets. Version with flowmeter

Verteilermodul mit Verteilern aus rostfreiem Stahl AISI 304 mit EK Übergang 1"x3/4". Vormontiert in einem lackiertem Metallkasten RAL 9010, Verteiler ausgestattet mit: thermostatisierbaren Ventilen (für den thermoelektrischen Kopf), dreheinstellbarem Füll- und Entleerungshahn, Luftablassventil, Absperrkugelhähnen, Kappen und Befestigungsklammern. Ausführung mit Durchflussmesser

Module de distribution avec collecteurs en acier inoxydable AISI 304, 1"x3/4" EK. Préassemblé dans un boîtier métallique verni RAL 9010, collecteurs pourvus de vanne thermostatissables (pour la tête thermoelectrique), robinet orientable de chargement/déchargement, vanne de purge de l'air, vannes d'arrêt, bouchons et plaque d'ancrage. Version avec mesureurs de débit

Распределительный модуль с коллекторами из нержавеющей стали AISI 304 1" x 3/4" Евроконус. Собранный коллекторный модуль вмонтирован в металлический шкаф, окрашенный RAL 9010. Состоит из: термостатических клапанов(для термостатических головок), дренажного клапана, воздушного клапана, шаровых кранов, заглушек и креплений. Данная версия с расходомерами

| Cod. Sx/Left | Cod. Dx/Right | Vie/Ways | L(mm) | H(mm) | P(mm) | € |
|--------------|---------------|----------|-------|-------|-------|--------|
| 50900200BA | 50910200BA | 2 | 400 | 630 | 90 | 231,23 |
| 50900200BB | 50910200BB | 3 | 500 | 630 | 90 | 260,80 |
| 50900200BC | 50910200BC | 4 | 500 | 630 | 90 | 284,60 |
| 50900200BD | 50910200BD | 5 | 600 | 630 | 90 | 321,43 |
| 50900200BE | 50910200BE | 6 | 600 | 630 | 90 | 344,37 |
| 50900200BF | 50910200BF | 7 | 700 | 630 | 90 | 376,32 |
| 50900200BG | 50910200BG | 8 | 700 | 630 | 90 | 399,77 |
| 50900200BH | 50910200BH | 9 | 850 | 630 | 90 | 445,12 |
| 50900200BJ | 50910200BJ | 10 | 850 | 630 | 90 | 468,64 |
| 50900200BK | 50910200BK | 11 | 850 | 630 | 90 | 491,79 |
| 50900200BL | 50910200BL | 12 | 1000 | 630 | 90 | 534,51 |

IVR MULTIKLIMA

Gruppi di miscelazione / Mixing units



IVR 711



IVR 711/A
Circolatore classe "A"
RS25/6-RKA M Wilo
Cod. 171115007



IVR 711/C
Circolatore a 3 velocità
NYL33-25 P Salmson
Cod. 171115001



IVR 711/S
Senza Circolatore
Cod. 171115000

Gruppo di miscelazione a punto fisso con testa termostatica
Fixed point mixing unit with thermostatic head
Fest eingestellte Mischgruppe mit Thermostatkopf
Groupe de mélange à point fixe avec tête thermostatique
Смесительная группа с фиксированной точкой и термостатической головкой IVR.

| Cod./Code | Misura/Size | □/田 | € |
|-----------|-------------|-----|--------|
| 171115007 | 3/4" x 1" | 1 | 323,81 |
| 171115001 | 3/4" x 1" | 1 | 226,31 |
| 171115000 | 3/4" x 1" | 1 | 105,51 |

IVR 712



IVR 712/A
Circolatore classe "A"
RS25/6-RKA M Wilo
Cod. 171215007



IVR 712/C
Circolatore a 3 velocità
NYL33-25 P Salmson
Cod. 171215001



IVR 712/S
Senza Circolatore
Cod. 171215000

Gruppo di miscelazione a punto fisso con miscelatore termostatico
Fixed point mixing unit with thermostatic mixing valve
Fest eingestellte Mischgruppe mit thermostatmischer Mischer
Groupe de mélange à point fixe avec mitigeur thermostatique
Смесительная группа с фиксированной точкой и термостатическим смесителем.

| Cod./Code | Misura/Size | □/田 | € |
|-----------|-------------|-----|--------|
| 171215007 | 3/4" x 1" | 1 | 427,08 |
| 171215001 | 3/4" x 1" | 1 | 325,74 |
| 171215000 | 3/4" x 1" | 1 | 204,21 |

IVR 713



IVR 713/A
Circolatore classe "A"
RS25/6-RKA M Wilo
Cod. 171315007



IVR 713/C
Circolatore a 3 velocità
NYL33-25 P Salmson
Cod. 171315001



IVR 713/S
Senza Circolatore
Cod. 171315000

Gruppo di miscelazione modulante con servocomando elettronico
Modulating mixing unit with electronic actuator
Modulierende Mischgruppe mit elektrothermischer Servosteuerung
Groupe de mélange modulant avec servocommande électrothermique
Смесительная группа с электротермическим приводом.

| Cod./Code | Misura/Size | □/田 | € |
|-----------|-------------|-----|--------|
| 171315007 | 3/4" x 1" | 1 | 403,98 |
| 171315001 | 3/4" x 1" | 1 | 306,48 |
| 171315000 | 3/4" x 1" | 1 | 184,95 |

IVR 714



Gruppo by-pass con valvola di regolazione micrometrica e termostato di sicurezza (taratura 50° C)
 By-pass unit with micrometric regulating valve and safety thermostat (set at 50° C).
 Bypass-Gruppe mit mikrometrischem Einstellventil und Sicherheitsthermostat (eingestellt um 50°)
 Groupe by-pass avec vanne de réglage micrométrique et thermostat de sécurité (réglé à 50° C)
 Группа бай-пасс с регулирующим микрометрическим клапаном и предохранительным термостатом(калибровка 50° C)

| Cod./Code | Misura/Size | L | □/田 | € |
|-----------|-------------|-----|-----|-------|
| 171410501 | 1" | 277 | 1 | 92,49 |

Senza termostato di sicurezza
 Without safety thermostat

| Cod./Code | Misura/Size | L | □/田 | € |
|-----------|-------------|-----|-----|-------|
| 171410502 | 1" | 277 | 1 | 64,27 |

IVR 714/R



Raccordo 3 pezzi portasonda per gruppi di miscela IVR 711
 Three-piece sensor connection for mixing units IVR 711
 Dreiteiliger Anschluss für Mischergruppen IVR 711
 Raccord à trois pièces pour groupes de mélange IVR 711
 Трехсоставной фитинг для смесительной группы IVR 711

| Cod./Code | Misura/Size | □/田 | € |
|-----------|-------------|------|-------|
| 171431001 | 1" | 8/48 | 17,75 |

IVR 330



Separatore idraulico in acciaio inox aisi 304 completo di raccordi
 Hydraulic separator in stainless steel AISI 304 with unions
 Hydraulische Weiche aus rostfreiem Stahl AISI 304 mit Anschlüssen
 Séparateur hydraulique en acier inoxydable AISI 304 avec raccords
 Гидравлический сепаратор из нержавеющей стали AISI 304 в комплекте с фитингами

| Cod./Code | Misura/Size | □/田 | € |
|-----------|-------------|-----|--------|
| 133027701 | 1" M x 1" F | 1/1 | 180,17 |

IVR 330/C



Guscio di coibentazione per separatore idraulico
 Isolation for hydraulic separator
 Isolierung für hydraulische Weiche
 Isolation pour le séparateur hydraulique
 Изоляция для гидравлического сепаратора

| Cod./Code | Misura/Size | □/田 | € |
|-----------|-------------|-----|-------|
| 335800420 | | 1/1 | 23,90 |

IVR 591 - TESTA TERMOSTATICA SUNNY SONDA IMMERSIONE



Testa termostatica con sensore a liquido a bassa inerzia termica - con sonda ad immersione
Thermostatic head with liquid sensor at low thermal inertia - with sensor immersion sleeve
Thermostatkopf mit Flüssigkeitssensor mit geringer thermischen Trägheit - mit Tauchsonde
Tête thermostatique avec capteur à liquide à faible inertie thermique - avec sonde à immersion
Термостатическая головка с жидкостным сенсором, низкой термоинерцией и погружным датчиком

| Cod./Code | Misura/Size | □/田 | € |
|-----------|-------------|------|-------|
| 159100001 | M30 x 1,5 | 1/20 | 21,14 |

IVR 331 - SERVOCOMANDO 0-10 24V NC



Servocomando 0-10 24V NC
Actuator 0-10 24 V NC (normally closed position)
Servosteuerung 0-10 24V (normalerweise geschlossen)
Servocommande 0-10 24V (normalement fermé)
Сервопривод 0-10 24V NC (нормально закрытый)

| Cod./Code | Misura/Size | □/田 | € |
|------------|-------------|------|-------|
| 1331AXS122 | M30 x 1,5 | 4/16 | 87,30 |

IVR 332 - TERMOSTATO DI SICUREZZA



Termostato di sicurezza
Safety thermostat
Sicherheitsthermostat
Thermostat de sécurité
Предохранительный термостат

| Cod./Code | Misura/Size | T° | □/田 | € |
|-----------|-------------|-----|-------|-------|
| 133205640 | 1/2" | 40° | 8/120 | 31,64 |
| 133205650 | 1/2" | 50° | 8/120 | 32,76 |

COLLETTORI / MANIFOLDS

Collettori Inox / Inox Manifolds
GLOBO

IVR 982/A - 982/B



Valvola a sfera a passaggio totale con bocchettone - attacchi M/F, sede conica, con autotenuta
Full bore ball valve with tail piece - M/F, with conical seat and auto-sealing
Kugelhahn mit vollem Durchgang und Rohrverschraubung - AG/IG, mit Kugelsitz und Selbstdichtung
Vanne à boisseau sphérique à passage intégral avec raccord - M/F, avec siège conique et auto-étanche
Полнопроходной шаровой кран со штоном и накидной гайкой - соединения Н/В, с коническим седлом и герметичной прокладкой

| Cod./Code | Misura/Size | □/田 | € |
|-----------|------------------|-------|-------|
| 198205058 | 1/2" x 1/2" Red | 10/60 | 7,80 |
| 198205061 | 1/2" x 1/2" Blue | 10/60 | 7,80 |
| 198207078 | 3/4" x 3/4" Red | 10/60 | 11,66 |
| 198207081 | 3/4" x 3/4" Blue | 10/60 | 11,66 |
| 198207108 | 3/4" x 1" Red | 10/60 | 13,26 |
| 198207111 | 3/4" x 1" Blue | 10/60 | 13,26 |
| 198210108 | 1" x 1" Red | 10/40 | 19,93 |
| 198210111 | 1" x 1" Blue | 10/40 | 19,93 |

IVR 206/A - 206/B



Valvola a sfera a passaggio totale con dado folle - attacchi F/F, sede piana
Full bore ball valve with crazy nut - F/F, with flat seat
Kugelhahn mit vollem Durchgang und verrückter Nuss - IG/IG, mit Flachsitz
Vanne à boisseau sphérique à passage intégral avec écrou fou - F/F, avec siège plate
Полнопроходной шаровой кран с накидной гайкой - соединения В/В, с плоским седлом

| Cod./Code | Misura/Size | □/田 | € |
|-----------|------------------|-------|-------|
| 120605108 | 1/2" x 3/4" Red | 10/60 | 9,56 |
| 120605111 | 1/2" x 3/4" Blue | 10/60 | 9,56 |
| 120607078 | 3/4" x 3/4" Red | 10/60 | 9,66 |
| 120607081 | 3/4" x 3/4" Blue | 10/60 | 9,66 |
| 120607208 | 3/4" x 1" Red | 10/40 | 12,19 |
| 120607211 | 3/4" x 1" Blue | 10/40 | 12,19 |

| Cod./Code | Misura/Size | □/田 | € |
|-----------|--------------|-------|-------|
| 196410008 | 1" x 1" Red | 10/40 | 19,14 |
| 196410211 | 1" x 1" Blue | 10/40 | 19,14 |

IVR 205/A - 205/B

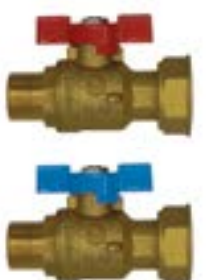

Valvola a sfera a passaggio totale con dado folle - attacchi M/F, sede piana
Full bore ball valve with crazy nut - M/F, with flat seat
Kugelhahn mit vollem Durchgang und verrückter Nuss - AG/IG, mit Flachsitz
Vanne à boisseau sphérique à passage intégral avec écrou fou - M/F, avec siège plate
Полнопроходной шаровой кран с накидной гайкой - соединения Н/В, с плоским седлом

| Cod./Code | Misura/Size | □/田 | € |
|-----------|-----------------|-------|-------|
| 120505077 | 1/2" x 3/4" RED | 10/40 | 9,37 |
| 120505211 | 1/2" x 3/4" BLU | 10/40 | 9,37 |
| 120507208 | 3/4" x 1" RED | 10/40 | 12,73 |
| 120507211 | 3/4" x 1" BLU | 10/40 | 12,73 |





IVR 980/A - 980/B



Valvola a sfera a passaggio totale con bocchettone - attacchi M/F, sede piana, con autotenuta
Full bore ball valve with tail piece - M/F, with flat seat and auto-sealing
Kugelhahn mit vollem Durchgang und Rohrverschraubung - AG/IG, mit Flachem Sitz und Selbstdichtung
Vanne à boisseau sphérique à passage intégral avec raccord - M/F, avec siège plate et auto-étanche
Полнопроходной шаровой кран со сгоном и накидной гайкой – соединения Н/В с плоским седлом и герметичной прокладкой

| Cod./Code | Misura/Size | □/田 | € |
|-----------|--------------------|-------|-------|
| 198010008 | 1" x 1" Red | 10/40 | 19,53 |
| 198010211 | 1" x 1" Blue | 10/40 | 19,53 |
| 198012008 | 1"1/4 x 1"1/4 Red | 8/32 | 35,90 |
| 198012211 | 1"1/4 x 1"1/4 Blue | 8/32 | 35,90 |

- NOTA: DISPONIBILE CON FILETTATURA NPT: ultime due cifre del codice sono "16"
- NOTE: AVAILABLE WITH THREADED END NPT: last two digits of code is "16"
- ANMERKUNG: ERHÄLTICH MIT NPT-GEWINDE: die letzten beiden Ziffern der Artikelnummer sind "16"
- NOTE: DISPONIBLE AVEC FILETAGE NPT: les deux derniers chiffres du code sont "16"
- ПРИМЕЧАНИЕ: ДОСТУПНО С РЕЗЬБОЙ NPT: две последние цифры кода "16"

IVR 981/A - 981/B



Valvola a sfera a passaggio totale a squadra con bocchettone - attacchi M/F, sede piana, con autotenuta
Angle full bore ball valve with tail piece - M/F, with flat seat and auto-sealing
Kugelhahn mit vollem Durchgang, eckförmig, Rohrverschraubung - AG/IG, mit Flachem Sitz und Selbstdichtung
Vanne à boisseau sphérique à passage intégral à équerre avec raccord - M/F, avec siège plate et auto-étanche
Полнопроходной угловой шаровой кран со сгоном и накидной гайкой – соединения Н/В с плоским седлом и герметичной прокладкой

| Cod./Code | Misura/Size | □/田 | € |
|-----------|--------------|-------|-------|
| 198110008 | 1" x 1" Red | 10/40 | 24,76 |
| 198110211 | 1" x 1" Blue | 10/40 | 24,76 |

IVR 827/A - IVR 827/B

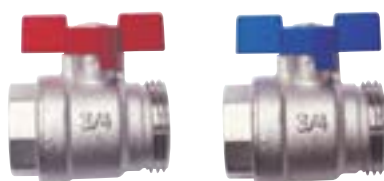

Maniglia farfalla rossa - Maniglia farfalla blu, sede piana
Red butterfly handle - Blue butterfly handle, flat seat
Rot und/oder Blau Flügelgriff mit flachem Sitz
Poignée papillon rouge - poignée papillon bleu avec siège plate
Красная ручка-бабочка - Синяя ручка-бабочка, плоское седло.

| Cod./Code | Misura/Size | □/田 | € |
|-----------|----------------|-------|------|
| 182707002 | Red 3/4" x 1" | 10/60 | 7,60 |
| 182707011 | Blue 3/4" x 1" | 10/60 | 7,60 |

COLLETTORI / MANIFOLDS

Collettori Inox / Inox Manifolds
GLOBO TERMOMETRO



Valvola a sfera M/F, attacco termometro, bocchettone autotenuta, nichelata. Per AVANT FLOOR
Ball valve M/F with thermometer, auto seal tailpiece, nickel plated. For AVANT FLOOR
Kugelhahn AG x IG mit Innen- und Außengewinde, Thermometeranschluss, selbstdichtendem Stutzen, vernickelt - für AVANT FLOOR
Vanne à boisseau sphérique M/F, fixation thermomètre, raccord autoétanche, nickelée - pour AVANT FLOOR
Шаровой никелированный кран с термометром, сгоном, самогерметизирующейся прокладкой, соединение - Н/В, для AVANT FLOOR

IVR 979/A - 979/B



Maniglia farfalla rossa / blu e attacco sonda per temperatura. Sede conica
Red/blue butterfly handle and sensor connection. Conical seat
Roter/blauer Flügelgriff und Anschluss für Temperatursonde mit Kugelsitz.
Poignée papillon rouge/bleu et fixation sonde pour température
Красная/синяя ручка-бабочка и соединение для температурного зонда. С коническим седлом

| Cod./Code | Misura/Size | | □/田 | € |
|-----------|--------------|---------|-------|-------|
| 197910008 | 1" x 1" Red | M10 x 1 | 10/40 | 32,91 |
| 197910211 | 1" x 1" Blue | M10 x 1 | 10/40 | 32,91 |

IVR 820



Termometro con guaina completo per IVR 979/A - IVR 979/B
Thermometer with pocket for IVR 979/A - IVR 979/B
Thermometer mit Hülle für IVR 979/A - IVR 979/B
Thermomètre avec gaine complète pour IVR 978/A - IVR 978/B - IVR 979/A - IVR 979/B
Термометр с кожухом для IVR 979/A - IVR 979/B

| Cod./Code | Misura/Size | □/田 | € |
|-----------|-------------|--------|------|
| 182003001 | 3/8" - Ø 41 | 10/150 | 7,76 |

COLLETTORI / MANIFOLDS
Collettori Inox / Inox Manifolds
VALVOLE PORTASONDA



Valvola a sfera a passaggio totale - con portasonda
Full bore ball valve with sensor connection
Kugelhahn mit vollem Durchgang mit Anschluss für Temperatursonde
Vanne à sphère à passage total avec fixation sonde pour température
Полнопроходной шаровой кран с соединением для датчика температуры

IVR 954 S



Attacchi F/F
Threaded ends F/F
Alle IG/IG
Fixations F/F
Соединения - В/В

| Cod./Code | Misura/Size | | □/田 | € |
|-----------|-------------|---------|-------|-------|
| 195405711 | 1/2" | M10 x 1 | 20/80 | 7,37 |
| 195407711 | 3/4" | M10 x 1 | 12/48 | 9,29 |
| 195410711 | 1" | M10 x 1 | 12/48 | 15,01 |

IVR 944/AS



Con bocchettone autotenuta. Sede conica M/F
Auto seal tailpiece. Conical seat M/F
Mit Selbstdichtung. Kegelsitz AG/IG
Avec raccord avec auto-étanche M/F
Со штоном и самогерметизирующейся прокладкой. С коническим седлом Н/В

| Cod./Code | Misura/Size | | □/田 | € |
|-----------|-------------|---------|-------|-------|
| 194407078 | 3/4" x 3/4" | M10 x 1 | 10/40 | 17,45 |
| 194407108 | 3/4" x 1" | M10 x 1 | 10/40 | 18,78 |
| 194410108 | 1" x 1" | M10 x 1 | 10/40 | 23,81 |

COLLETTORI / MANIFOLDS

Testa termoelettrica / Thermo-electric actuator



Testa termoelettrica fornita nella versione NC (normalmente chiusa) o NO (normalmente aperta) per AVANT FLOOR
Thermo-electric actuator, version NC (normally closed position) or NO (normally open position) for AVANT FLOOR
Thermoelektrischer Kopf, erhältlich in den Ausführungen NC (normalerweise geschlossen) - NO (normalerweise geöffnet) - für AVANT
Tête thermoélectrique fournie dans la version NC (normalement fermée) - NO (normalement ouverte) AVANT FLOOR
Термоэлектропривод, NC (нормально закрытый) или NO (нормально открытый) для AVANT FLOOR

IVR 823



NC



NO

Testa termoelettrica fornita nella versione NC (normalmente chiusa) o NO (normalmente aperta) per AVANT FLOOR - 230 V

Thermo-electric actuator, version NC (normally closed position) or NO (normally open position) for AVANT FLOOR - 230 V

Thermoelektrischer Kopf, erhältlich in den Ausführungen NC (normalerweise geschlossen) - NO (normalerweise geöffnet) - für AVANT FLOOR 230 V

Tête thermoélectrique fournie dans la version NC (normalement fermée) - NO (normalement ouverte) AVANT FLOOR - 230 V

Термоэлектропривод, NC (нормально закрытый) или NO (нормально открытый) для коллекторов AVANT FLOOR - 230 V

| Cod./Code | Misura/Size | □/田 | € |
|-----------|-------------|------|-------|
| 182300101 | 230V NC | 1/10 | 25,88 |
| 182300110 | 230V NO | 1/10 | 25,88 |

Con microinterruttore ausiliario / With auxiliary microswitch / Mit Mikroschalter
Avec contact auxiliaire / С дополнительным микро-переключателем

| Cod./Code | Misura/Size | □/田 | € |
|-----------|-------------|------|-------|
| 182300140 | 230V NC | 1/24 | 33,98 |

IVR 824



NC



NO

Testa termoelettrica fornita nella versione NC (normalmente chiusa) o NO (normalmente aperta) per AVANT FLOOR - 24 V

Thermo-electric actuator, version NC (normally closed position) or NO (normally open position) for AVANT FLOOR - 24 V

Thermoelektrischer Kopf, erhältlich in den Ausführungen NC (normalerweise geschlossen) - NO (normalerweise geöffnet) - für AVANT FLOOR - 24 V

Tête thermoélectrique fournie dans la version NC (normalement fermée) - NO (normalement ouverte) AVANT FLOOR - 24 V

Термоэлектропривод, NC (нормально закрытый) или NO (нормально открытый) для коллекторов AVANT FLOOR - 24 V

| Cod./Code | Misura/Size | □/田 | € |
|-----------|-------------|------|-------|
| 182400101 | 24V NC | 1/10 | 25,88 |
| 182400110 | 24V NO | 1/10 | 25,88 |

Con microinterruttore ausiliario / With auxiliary microswitch / Mit Hilfs-Mikroschalter
Avec contact auxiliaire / С дополнительным микро-переключателем

| Cod./Code | Misura/Size | □/田 | € |
|-----------|-------------|------|-------|
| 182400140 | 24V NC | 1/24 | 37,88 |



COLLETTORI / MANIFOLDS

Collettori Inox / Inox Manifolds
AVANT ACCESSORIES

Accessori per AVANT FLOOR
Accessories for AVANT FLOOR
Zubehöre für AVANT FLOOR
accessoire pour AVANT FLOOR
аксессуары для коллектора AVANT FLOOR

IVR 825



Termostato ambiente a parete 230 V
Room thermostat 230 V
Raumthermostat als Wandausführung 230 V
Thermostat ambient mural 230 V
Настенный термостат для жилых помещений 230 V

| Cod./Code | Misura/Size | □/田 | € |
|-----------|-------------|------|-------|
| 182500001 | 230V | 1/50 | 13,69 |

IVR 821

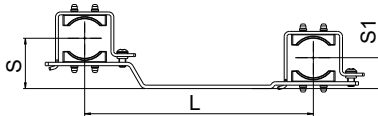

Set di 2 zanche doppie di fissaggio antivibrazione per AVANT FLOOR
Set of 2 double insulated vibration-free mounting bracket for AVANT FLOOR
Garnitur mit 2 doppelten schwingungsdämpfenden Befestigungsklammern für AVANT FLOOR
Kit de 2 doubles plaques d'ancrage antivibration pour AVANT FLOOR
Комплект из двух двойных антивибрационных кронштейнов для AVANT FLOOR

| Cod./Code | Misura/Size | S(mm) | L(mm) | S1(mm) | □/田 | € |
|-----------|-------------|-------|-------|--------|------|------|
| 182100030 | 1" | 44 | 200 | 27 | 1/50 | 7,07 |
| 182100032 | 1"1/4 | 49 | 200 | 32 | 1/20 | 7,67 |

IVR 840

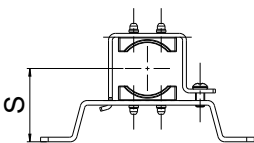

Set di 2 zanche singole di fissaggio antivibrazione per AVANT FLOOR
Set of 2 single insulating vibration-free mounting bracket for AVANT FLOOR
Garnitur mit 2 einzigen schwingungsdämpfenden Befestigungsklammern für AVANT FLOOR
Kit de 2 plaques simples d'ancrage antivibration pour AVANT FLOOR
Комплект из двух отдельных антивибрационных кронштейнов для AVANT FLOOR

| Cod./Code | Misura/Size | S(mm) | L(mm) | S1(mm) | □/田 | € |
|-----------|-------------|-------|-------|--------|-------|------|
| 184010050 | 1" | 48 | | | 20/80 | 5,04 |
| 184012050 | 1"1/4 | 50 | | | 20/80 | 4,14 |

| Cod./Code | Misura/Size | S(mm) | L(mm) | S1(mm) | □/田 | € |
|-----------|-------------|-------|-------|--------|-------|------|
| 184010052 | 1" | 83 | | | 20/80 | 5,00 |
| 184012052 | 1"1/4 | 85 | | | 20/80 | 5,00 |

IVR 404



Raccordo sdoppiatore Y per AVANT FLOOR
 Y junction splitter for AVANT FLOOR
 Y-Verteiler Splitter für AVANT FLOOR
 Y jonction séparateur pour AVANT FLOOR
 Y - разделитель потока для AVANT FLOOR

| Cod./Code | Misura/Size | Attacco/Connection | □/田 | € |
|-----------|-------------|--------------------|-------|-------|
| 140407001 | 3/4" EK | 3/4" EK | 10/60 | 11,93 |

IVR 408 K



Per IVR 802 - IVR 804
 For IVR 802 - IVR 804
IVR 408/1 K



Per IVR 803 - IVR 805
 For IVR 803 - IVR 805
IVR 408/2 K



Per IVR 800 - IVR 806
 For IVR 800 - IVR 806
IVR 408/3 K



Per IVR 801 - IVR 807
 For IVR 801 - IVR 807
IVR 408/4 K



Per tutti i collettori AVANT FLOOR/
 For all AVANT FLOOR manifolds
IVR 408/5 K



Per tutti i collettori AVANT FLOOR/
 For all AVANT FLOOR manifolds
IVR 408/6 K



Per tutti i collettori AVANT FLOOR/
 For all AVANT FLOOR manifolds
IVR 408/7 K

Kit estensione per AVANT FLOOR
 Extension Kit for AVANT FLOOR
 Extension Kit für AVANT FLOOR
 Kit d'extension pour AVANT FLOOR
 Дополнительный комплект для AVANT FLOOR

| Cod./Code | Modello/Model AvantFloor | Vie/Ways | Misura/Size | □/田 | € |
|-----------|--------------------------|----------|-------------|------|-------|
| 140820571 | IVR 408/1 K | 1 | 1" | 1/18 | 29,31 |
| 140820576 | IVR 408/2 K | 1 | 1" | 1/18 | 30,10 |
| 140820580 | IVR 408/3 K | 1 | 1" | 1/24 | 24,03 |
| 140820581 | IVR 408/4 K | 1 | 1" | 1/24 | 24,82 |
| 140820590 | IVR 408/5 K | 1 | 1" | 1/24 | 24,38 |
| 140820591 | IVR 408/6 K | 1 | 1" | 1/18 | 35,89 |
| 140820592 | IVR 408/7 K | 1 | 1" | 1/12 | 30,11 |

IVR 822

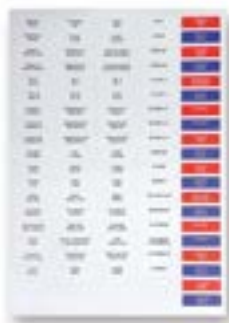

Etichette autoadesive
 Stickers
 Klebeetiketten
 Étiquettes autocollantes
 Стикеры

| Cod./Code | Tipo/Type | □/田 | € |
|-----------|-----------|----------|------|
| 182200001 | IVR 822 | 100/1200 | 0,44 |

IVR 847 A



Guscio isolante aperto 12 uscite superiori ed inferiori per AVANT FLOOR
Open insulating shell with upper and lower 12 ways for AVANT FLOOR
Geöffnete Isolierhülse mit 12 oberen und unteren Ausgängen für Verteiler AVANT FLOOR
Coque isolante ouverte pour 12 sorties inférieures et supérieures pour AVANT FLOOR
Изоляция 12 верхних и нижних выходов для коллекторов AVANT FLOOR

| Cod./Code | Misura/Size | □/田 | € |
|-----------|-------------|-----|-------|
| 1847A1012 | 1" | 10 | 10,05 |
| 1847A1212 | 1"1/4 | 10 | 10,05 |

IVR 847 C



Guscio isolante chiuso 12 uscite inferiori per AVANT FLOOR
Closed insulating shell with 12 lower ways for AVANT FLOOR
Geschlossene Isolierhülse mit 12 unteren Ausgängen für Verteiler AVANT FLOOR
Coque isolante "fermée" pour 12 sorties inférieures pour AVANT FLOOR
Изоляция "Закрытая" 12 нижних выходов для коллекторов AVANT FLOOR

| Cod./Code | Misura/Size | □/田 | € |
|-----------|-------------|-----|-------|
| 1847C1012 | 1" | 10 | 10,05 |
| 1847C1212 | 1"1/4 | 10 | 10,05 |

IVR 897



Termometro a contatto per AVANT FLOOR
Contact thermometer for AVANT FLOOR
Kontaktthermometer für AVANT FLOOR
Thermomètre à contact pour AVANT FLOOR
Контактный термометр для коллекторов AVANT FLOOR

| Cod./Code | Øe | □/田 | € |
|-----------|----|--------|------|
| 189700010 | 40 | 10/120 | 7,43 |

COLLETTORI / MANIFOLDS

Collettori Industriali / Industrial Manifolds

IVR INOX

Collettore Industriale in acciaio inox AISI 304 1"1/2 - 2", interasse 70 mm., rubinetto carico/scarico acqua (adattatore da 1"), trattamento di elettrolucidatura

Stainless steel AISI 304 Industrial Manifold 1"1/2 - 2", center hole distance 70 mm., draining valve (adapter connection 1"), electro-polished treatment

Industrie-Verteiler aus rostfreiem Edelstahl AISI 304 1"1/2"- 2" - Abstand 70 mm. Füll-Entleerungshahn (1" Zwischenstück / Adapter), Elektropoliturbehandlung

Collecteur Industriel en acier inox AISI 304 1"1/2 - 2", avec vanne à boisseau sphérique de sectionnement (adaptateur 1") robinet purge et chargement, traitement d'électropolissage

Индустриальный коллектор из нержавеющей стали AISI 304, диаметр 1"1/2 - 2", межосевое расстояние 70мм, дренажный кран (адаптер 1"), электрополировка

IVR 882

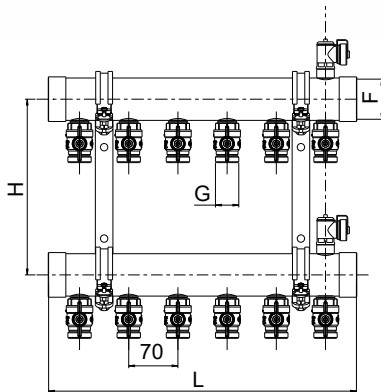
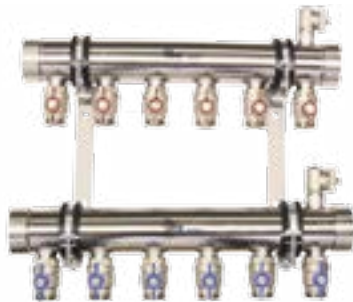

Con valvola a sfera d'intercettazione

With interception valve

Mit Absperrventil

Avec vanne à boisseau sphérique de sectionnement

С шаровым краном перехвата

| Cod./Code | (F) Misura/Size | (G) Attacco/Connection | Vie/Ways | L(mm) | H(mm) | □/田 | € |
|-----------|-----------------|------------------------|----------|-------|-------|-----|--------|
| 188242704 | 1"1/2 | 1" | 4 | 291 | 250 | 1 | 250,04 |
| 188242705 | 1"1/2 | 1" | 5 | 361 | 250 | 1 | 281,33 |
| 188242706 | 1"1/2 | 1" | 6 | 431 | 250 | 1 | 318,89 |
| 188242707 | 1"1/2 | 1" | 7 | 501 | 250 | 1 | 355,98 |
| 188242708 | 1"1/2 | 1" | 8 | 571 | 250 | 1 | 392,90 |
| 188242709 | 1"1/2 | 1" | 9 | 641 | 250 | 1 | 433,73 |
| 188242710 | 1"1/2 | 1" | 10 | 711 | 250 | 1 | 478,15 |
| 188242711 | 1"1/2 | 1" | 11 | 781 | 250 | 1 | 519,99 |
| 188242712 | 1"1/2 | 1" | 12 | 851 | 250 | 1 | 561,88 |
| 188242713 | 1"1/2 | 1" | 13 | 921 | 250 | 1 | 602,55 |
| 188242714 | 1"1/2 | 1" | 14 | 991 | 250 | 1 | 643,23 |
| | | | | | | | |
| 188252704 | 2" | 1" | 4 | 299 | 250 | 1 | 273,57 |
| 188252705 | 2" | 1" | 5 | 369 | 250 | 1 | 312,37 |
| 188252706 | 2" | 1" | 6 | 439 | 250 | 1 | 359,30 |
| 188252707 | 2" | 1" | 7 | 509 | 250 | 1 | 388,14 |
| 188252708 | 2" | 1" | 8 | 579 | 250 | 1 | 426,94 |
| 188252709 | 2" | 1" | 9 | 649 | 250 | 1 | 473,76 |
| 188252710 | 2" | 1" | 10 | 719 | 250 | 1 | 526,80 |
| 188252711 | 2" | 1" | 11 | 789 | 250 | 1 | 560,78 |
| 188252712 | 2" | 1" | 12 | 859 | 250 | 1 | 604,92 |
| 188252713 | 2" | 1" | 13 | 929 | 250 | 1 | 617,84 |
| 188252714 | 2" | 1" | 14 | 999 | 250 | 1 | 682,51 |

IVR 883

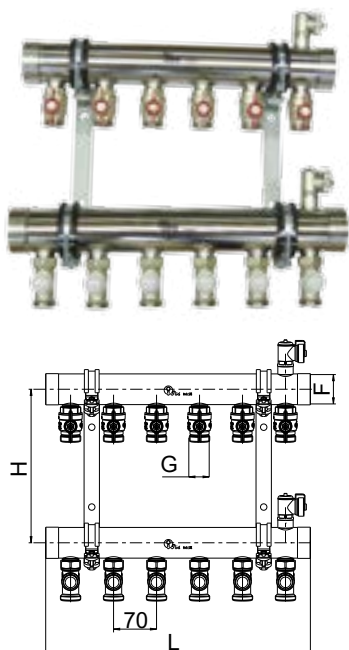

Con valvola a sfera d'intercettazione e detentore micrometrico
With interception valve and micrometric lockshield
Mit Absperrventil und mikrometrischer Rücklaufverschraubung
Avec vanne à boisseau sphérique de sectionnement et coude de réglage micrométriques
С шаровым краном перехвата

| Cod./Code | (F) Misura/Size | (G) Attacco/Connection | Vie/Ways | L(mm) | H(mm) | □/田 | € |
|-----------|-----------------|------------------------|----------|-------|-------|-----|--------|
| 188342704 | 1"1/2 | 1" | 4 | 291 | 250 | 1 | 248,19 |
| 188342705 | 1"1/2 | 1" | 5 | 361 | 250 | 1 | 279,02 |
| 188342706 | 1"1/2 | 1" | 6 | 431 | 250 | 1 | 316,12 |
| 188342707 | 1"1/2 | 1" | 7 | 501 | 250 | 1 | 352,75 |
| 188342708 | 1"1/2 | 1" | 8 | 571 | 250 | 1 | 389,21 |
| 188342709 | 1"1/2 | 1" | 9 | 641 | 250 | 1 | 429,57 |
| 188342710 | 1"1/2 | 1" | 10 | 711 | 250 | 1 | 473,53 |
| 188342711 | 1"1/2 | 1" | 11 | 781 | 250 | 1 | 514,91 |
| 188342712 | 1"1/2 | 1" | 12 | 851 | 250 | 1 | 556,34 |
| 188342713 | 1"1/2 | 1" | 13 | 921 | 250 | 1 | 596,55 |
| 188342714 | 1"1/2 | 1" | 14 | 991 | 250 | 1 | 636,76 |
| <hr/> | | | | | | | |
| 188352704 | 2" | 1" | 4 | 299 | 250 | 1 | 271,72 |
| 188352705 | 2" | 1" | 5 | 369 | 250 | 1 | 310,06 |
| 188352706 | 2" | 1" | 6 | 439 | 250 | 1 | 356,53 |
| 188352707 | 2" | 1" | 7 | 509 | 250 | 1 | 384,91 |
| 188352708 | 2" | 1" | 8 | 579 | 250 | 1 | 423,24 |
| 188352709 | 2" | 1" | 9 | 649 | 250 | 1 | 469,60 |
| 188352710 | 2" | 1" | 10 | 719 | 250 | 1 | 522,18 |
| 188352711 | 2" | 1" | 11 | 789 | 250 | 1 | 555,69 |
| 188352712 | 2" | 1" | 12 | 859 | 250 | 1 | 599,37 |
| 188352713 | 2" | 1" | 13 | 929 | 250 | 1 | 611,83 |
| 188352714 | 2" | 1" | 14 | 999 | 250 | 1 | 676,04 |

IVR 884

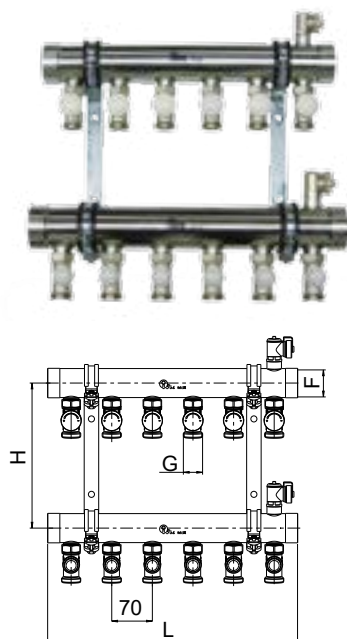

Con valvola termostattizzabile, cappello di regolazione, detentore micrometrico
With thermostatic valve, operating plastic cap and micrometric lockshield
Mit thermostatisierbarem Ventil, Einstellkappe und mikrometrischer Rücklaufverschraubung
Avec vanne thermostatizable, chapeau de réglage et coude de réglage micrométrique
С термостатическим клапаном, регулирующим колпачком и отсекающим клапаном

| Cod./Code | (F) Misura/Size | (G) Attacco/Connection | Vie/Ways | L(mm) | H(mm) | □/田 | € |
|-----------|-----------------|------------------------|----------|-------|-------|-----|--------|
| 188442704 | 1"1/2 | 1" | 4 | 291 | 250 | 1 | 252,71 |
| 188442705 | 1"1/2 | 1" | 5 | 361 | 250 | 1 | 284,68 |
| 188442706 | 1"1/2 | 1" | 6 | 431 | 250 | 1 | 322,91 |
| 188442707 | 1"1/2 | 1" | 7 | 501 | 250 | 1 | 360,66 |
| 188442708 | 1"1/2 | 1" | 8 | 571 | 250 | 1 | 398,25 |
| 188442709 | 1"1/2 | 1" | 9 | 641 | 250 | 1 | 439,74 |
| 188442710 | 1"1/2 | 1" | 10 | 711 | 250 | 1 | 484,83 |
| 188442711 | 1"1/2 | 1" | 11 | 781 | 250 | 1 | 527,35 |
| 188442712 | 1"1/2 | 1" | 12 | 851 | 250 | 1 | 569,91 |
| 188442713 | 1"1/2 | 1" | 13 | 921 | 250 | 1 | 611,25 |
| 188442714 | 1"1/2 | 1" | 14 | 991 | 250 | 1 | 652,59 |
| <hr/> | | | | | | | |
| 188452704 | 2" | 1" | 4 | 299 | 250 | 1 | 276,24 |
| 188452705 | 2" | 1" | 5 | 369 | 250 | 1 | 315,71 |
| 188452706 | 2" | 1" | 6 | 439 | 250 | 1 | 363,31 |
| 188452707 | 2" | 1" | 7 | 509 | 250 | 1 | 392,82 |
| 188452708 | 2" | 1" | 8 | 579 | 250 | 1 | 432,29 |
| 188452709 | 2" | 1" | 9 | 649 | 250 | 1 | 479,78 |
| 188452710 | 2" | 1" | 10 | 719 | 250 | 1 | 533,49 |
| 188452711 | 2" | 1" | 11 | 789 | 250 | 1 | 568,13 |
| 188452712 | 2" | 1" | 12 | 859 | 250 | 1 | 612,94 |
| 188452713 | 2" | 1" | 13 | 929 | 250 | 1 | 626,53 |
| 188452714 | 2" | 1" | 14 | 999 | 250 | 1 | 691,87 |

COLLETTORI / MANIFOLDS

Collettori Industriali / Industrial Manifolds
IVR INOX BASIC

IVR 893

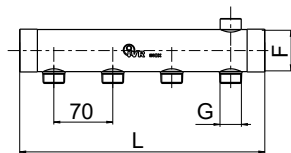

Collettore Industriale in acciaio inox AISI 304 1"1/2 - 2". interasse 70 mm., attacchi da 3/4", attacco per rubinetto carico/scarico, trattamento di elettrolucidatura

Stainless steel AISI 304 Industrial Manifold 1"1/2 - 2", outlet distance 70 mm, connections 3/4", draining valve connection, electropolished treatment

Industrie-Verteiler aus rostfreiem Edelstahl AISI 304 1"1/2 - 2" - Abstand 70 mm. Mit 3/4" Anschlüsse - Ein- und Ablassventil (1" Zwischenstück / Adapter), Elektropoliturbehandlung

Collecteur Industriel en acier inox AISI 304 1"1/2 - 2", entraxe 70mm, fixations de 3/4", traitement d'électropolissage

Индустриальный коллектор из нержавеющей стали AISI 304 1"1/2 - 2", выходы 3/4", межосевое расстояние 70мм, соединение для дренажного крана, электрополировка

| Cod./Code | (F) Misura/Size | (G) Attacco/Connection | Vie/Ways | L(mm) | H(mm) | □/⊕ | € |
|-----------|-----------------|------------------------|----------|-------|-------|-----|--------|
| 189342704 | 1"1/2 | 3/4" M | 4 | 291 | | 1 | 65,14 |
| 189342705 | 1"1/2 | 3/4" M | 5 | 361 | | 1 | 71,87 |
| 189342706 | 1"1/2 | 3/4" M | 6 | 431 | | 1 | 80,77 |
| 189342707 | 1"1/2 | 3/4" M | 7 | 501 | | 1 | 90,23 |
| 189342708 | 1"1/2 | 3/4" M | 8 | 571 | | 1 | 99,69 |
| 189342709 | 1"1/2 | 3/4" M | 9 | 641 | | 1 | 111,22 |
| 189342710 | 1"1/2 | 3/4" M | 10 | 711 | | 1 | 124,43 |
| 189342711 | 1"1/2 | 3/4" M | 11 | 781 | | 1 | 135,76 |
| 189342712 | 1"1/2 | 3/4" M | 12 | 851 | | 1 | 147,12 |
| 189342713 | 1"1/2 | 3/4" M | 13 | 921 | | 1 | 158,45 |
| 188342714 | 1"1/2 | 3/4" M | 14 | 991 | | 1 | 169,79 |
| | | | | | | | |
| 189352704 | 2" | 3/4" M | 4 | 299 | | 1 | 74,06 |
| 189352705 | 2" | 3/4" M | 5 | 369 | | 1 | 84,53 |
| 189352706 | 2" | 3/4" M | 6 | 439 | | 1 | 98,12 |
| 189352707 | 2" | 3/4" M | 7 | 509 | | 1 | 103,53 |
| 189352708 | 2" | 3/4" M | 8 | 579 | | 1 | 113,93 |
| 189352709 | 2" | 3/4" M | 9 | 649 | | 1 | 128,46 |
| 189352710 | 2" | 3/4" M | 10 | 719 | | 1 | 145,98 |
| 189352711 | 2" | 3/4" M | 11 | 789 | | 1 | 153,97 |
| 189352712 | 2" | 3/4" M | 12 | 859 | | 1 | 166,45 |
| 189352713 | 2" | 3/4" M | 13 | 929 | | 1 | 163,91 |
| 189352714 | 2" | 3/4" M | 14 | 999 | | 1 | 187,25 |



IVR 462

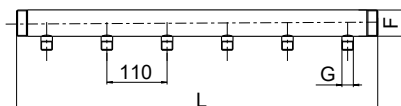

Collettore in acciaio inox AISI 304 da 1"1/2 - 2", con attacchi M/M da 1/2", interasse 110 mm; adatto per contatore acqua

Stainless steel AISI 304 Manifold 1"1/2 - 2" - connections M/M 1/2", center hole distance 110 mm; for water meter

Verteiler aus rostfreiem Stahl AISI 304 - 1"1/2 - 2" - alle Anschlüsse mit (AG x AG) Außengewinde 1/2", Abstand 110 mm; geeignet für Wasserzähler

Collecteur en acier inox AISI 304 de 1"1/2 - 2" - avec fixations M/M de 1/2", entraxe 110 mm pour compteur pour eau

Коллектор из нержавеющей стали AISI 304 1"1/2 - 2", выходы 1/2" Н/Н, межосевое расстояние 110 мм, для счетчиков воды

| Cod./Code | (F) Misura/Size | (G) Attacco/Connection | Vie/Ways | L(mm) | □/田 | € |
|-----------|-----------------|------------------------|----------|-------|-----|--------|
| 146240502 | 1"1/2 | 1/2" M | 2 | 220 | 5 | 45,00 |
| 146240503 | 1"1/2 | 1/2" M | 3 | 330 | 5 | 57,09 |
| 146240504 | 1"1/2 | 1/2" M | 4 | 440 | 5 | 67,30 |
| 146240505 | 1"1/2 | 1/2" M | 5 | 550 | 10 | 75,72 |
| 146240506 | 1"1/2 | 1/2" M | 6 | 660 | 10 | 84,05 |
| 146240507 | 1"1/2 | 1/2" M | 7 | 770 | 5 | 86,76 |
| 146240508 | 1"1/2 | 1/2" M | 8 | 880 | 6 | 102,59 |
| 146240509 | 1"1/2 | 1/2" M | 9 | 990 | 6 | 113,00 |
| 146240510 | 1"1/2 | 1/2" M | 10 | 1100 | 6 | 119,08 |
| 146250502 | 2" | 1/2" M | 2 | 224 | 10 | 50,63 |
| 146250503 | 2" | 1/2" M | 3 | 334 | 10 | 58,96 |
| 146250504 | 2" | 1/2" M | 4 | 444 | 5 | 66,55 |
| 146250505 | 2" | 1/2" M | 5 | 554 | 5 | 74,22 |
| 146250506 | 2" | 1/2" M | 6 | 664 | 5 | 81,80 |
| 146250507 | 2" | 1/2" M | 7 | 774 | 5 | 91,26 |
| 146250508 | 2" | 1/2" M | 8 | 884 | 5 | 98,84 |
| 146250509 | 2" | 1/2" M | 9 | 994 | 5 | 108,50 |
| 146250510 | 2" | 1/2" M | 10 | 1104 | 5 | 130,33 |

IVR 463

NEW

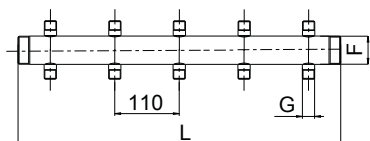

Collettore in acciaio inox AISI 304 da 1"1/2 - 2", con attacchi M/M da 1/2", interasse 110 mm; adatto per contatore acqua con attacchi contrapposti

Stainless steel AISI 304 manifold 1"1/2 - 2" - connections M/M 1/2", center hole distance 110 mm; for water meter with parallel connections

Verteiler aus rostfreiem Stahl AISI 304 - 1"1/2 - 2" - alle Anschlüsse AG/AG 1/2", Abstand 110 mm; geeignet für Wasserzähler mit Parallelanschlüssen

Collecteur en acier inox AISI 304 de 1"1/2 - 2" - avec fixations M/M de 1/2", entraxe 110 mm pour compteur pour eau avec fixations parallèles

Коллектор из нержавеющей стали AISI 304, диаметр 1"1/2 - 2", выходы 1/2" Н/Н, межосевое расстояние 110 мм, для счетчиков воды с противоположными соединениями

| Cod./Code | (F) Misura/Size | (G) Attacco/Connection | Vie/Ways | L(mm) | □/田 | € |
|-----------|-----------------|------------------------|----------|-------|-----|--------|
| 146340503 | 1"1/2 | 1/2" M | 3+3 | 330 | 1 | 90,84 |
| 146340504 | 1"1/2 | 1/2" M | 4+4 | 440 | 1 | 112,30 |
| 146340505 | 1"1/2 | 1/2" M | 5+5 | 550 | 1 | 131,97 |
| 146350503 | 2" | 1/2" M | 3+3 | 334 | 1 | 101,63 |
| 146350504 | 2" | 1/2" M | 4+4 | 444 | 1 | 121,13 |
| 146350505 | 2" | 1/2" M | 5+5 | 554 | 1 | 140,63 |

COLLETTORI / MANIFOLDS

Collettori Industriali / Industrial Manifolds
IVR INOX ACCESSORIES

Accessori per collettori IVR-INOX
Accessories for manifolds IVR-INOX
Zubehöre für Verteiler IVR-INOX
Accessoires pour collecteurs IVR-INOX
Аксессуары для коллекторов IVR-INOX

IVR 86/A - IVR 86/B

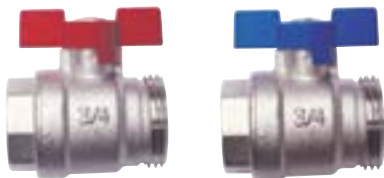

Maniglia farfalla rossa - Maniglia farfalla blu, sede conica
Red butterfly handle - Blue butterfly handle, conical seat
Rot und/oder Blau Flügelgriff mit Kugelsitz
Poignée papillon rouge - poignée papillon bleu avec siège conique
Красная ручка-бабочка - Синяя ручка-бабочка, коническое седло

| Cod./Code | Misura/Size | Attacco/Connection | □/田 | € |
|-----------|-------------|--------------------|-------|------|
| 108607102 | Red 3/4" | 1" | 10/60 | 7,46 |
| 108607104 | Blue 3/4" | 1" | 10/60 | 7,46 |

IVR 551/C



Detentore dritto, attacco tubo ferro, senza bocchettone, nichelato. Per IVR-INOX
Straight heavy lockshield, iron pipe connection, without tail piece, nickel plated. For IVR-INOX
Gerade Rücklaufverschraubung für Eisenrohr, ohne Stutzen, vernickelt. Für IVR-INOX
Coude droit, fixation tube fer, raccord autoétanche, nickelé. Pour IVR-INOX
Прямой отсекающий клапан, соединение для стальной трубы, без муфты, никелированный. Для IVR-INOX

| Cod./Code | Misura/Size | Attacco/Connection | □/田 | € |
|-----------|-------------|--------------------|--------|------|
| 155107010 | 3/4" | 1" | 10/120 | 7,00 |

IVR 566/C



Valvola termostaticabile dritta con cappello, attacco tubo ferro, senza bocchettone, nichelato. Per IVR-INOX
Straight thermostatic valve with plastic cap, iron pipe connection, without tail piece, nickel plated. For IVR-INOX
Thermostatventil mit gerader Verschraubung und Einstellkappe, ohne Stutzen, vernickelt. Für Verteiler IVR-INOX
Vanne thermostatisable avec chapeau de réglage, fixation tube fer, sans raccord, nickelée. Pour IVR-INOX
Прямой никелированный термостатический клапан с пластиковым колпачком, соединение для стальной трубы, без муфты. Для IVR-INOX

| Cod./Code | Misura/Size | Attacco/Connection | □/田 | € |
|-----------|-------------|--------------------|-------|------|
| 156607010 | 3/4" | 1" | 10/60 | 8,59 |



IVR 406



Nipples in acciaio inox AISI 304. Per collettori IVR-INOX
AISI 304 stainless steel nipples. For manifolds IVR-INOX
Nippel aus rostfreiem Edelstahl AISI 304. Für Verteiler IVR-INOX
Raccords autoétanche en acier AISI 304. Pour collecteurs IVR-INOX
Ниппели из нержавеющей стали AISI 304. Для коллекторов IVR-INOX

| Cod./Code | Misura/Size | □/⊞ | € |
|-----------|-------------|--------|-------|
| 140615001 | 1"1/2 | 10/120 | 17,61 |
| 140620001 | 2" | 10/60 | 16,33 |

IVR 416



Tappo M in acciaio inox AISI 304. Per IVR-INOX
Stainless steel AISI 304 M plug. For IVR-INOX
Deckel AG aus rostfreiem Stahl AISI 304. Für IVR-INOX
Bouchon M en acier inox AISI 304. Pour IVR-INOX
Заглушка из нержавеющей стали AISI 304 с наружной резьбой. Для коллекторов IVR-INOX

| Cod./Code | Misura/Size | □/⊞ | € |
|-----------|-------------|--------|-------|
| 141615001 | 1"1/2 | 10/120 | 16,25 |
| 141620001 | 2" | 10/60 | 17,90 |

IVR 417



Tappo F in acciaio inox AISI 304. Per IVR-INOX 462
Stainless steel AISI 304 F plug. For IVR-INOX 462
Deckel IG aus rostfreiem Stahl AISI 304. Für IVR-INOX 462
Bouchon F en acier inox AISI 304. Pour IVR-INOX 462
Заглушка из нержавеющей стали AISI 304 с внутренней резьбой. Для IVR-INOX 462

| Cod./Code | Misura/Size | □/⊞ | € |
|-----------|-------------|--------|-------|
| 141715001 | 1" 1/2 | 10/120 | 14,46 |
| 141720001 | 2" | 10/120 | 15,61 |

IVR 844

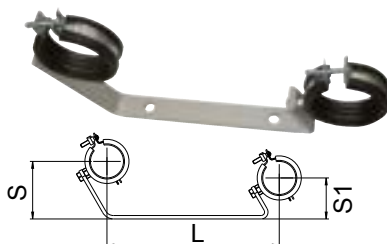

Zanca doppia per collettori. Per IVR-INOX
Dual bracket for modular manifolds. For IVR-INOX
Doppelklammern für Verteiler IVR-INOX
Plaque d'ancrage double pour collecteurs. Pour IVR-INOX
Двойной кронштейн для коллекторов IVR-INOX

| Cod./Code | Misura/Size | S (mm) | L (mm) | S1 (mm) | □/⊞ | € |
|-----------|-------------|--------|--------|---------|-----|-------|
| 184415001 | 1"1/2 | 83 | 250 | 59 | 2 | 17,39 |
| 184420001 | 2" | 87 | 250 | 63 | 2 | 21,28 |

IVR 847 I



Uscita zanca
At the outlet
Bei der Ausgang
Près de la sortie
Выход-кронштейн



Uscita intermedia
In the middle
In der Mitte
Dans la moitié
Промежуточный выход

Guscio isolante. Per IVR-INOX
Isolating element. For IVR-INOX
Isolierhülse. Für Verteiler IVR-INOX
Coque isolante. Pour collecteurs IVR-INOX
Изолирующий элемент. Для IVR-INOX

| Cod./Code | Misura/Size | □/⊞ | € |
|-----------|-----------------------------------|-----|-------|
| 184715031 | 1"1/2 - iniziale zanca - 3 uscite | 10 | 19,20 |
| 184715032 | 1"1/2 - intermedio - 3 uscite | 10 | 19,20 |
| 184720031 | 2" - iniziale zanca - 3 uscite | 10 | 20,29 |
| 184720032 | 2" - intermedio - 3 uscite | 10 | 20,29 |

COLLETTORI / MANIFOLDS

Collettori in ottone / Brass Manifolds
SUNNY FLOOR MODULAR

Collettore componibile stampato in ottone interasse 38 mm M/F 3/4" - 1"; nichelato
 Modular manifold forged brass, centre hole distance 38 mm M/F 3/4" - 1"; nickel-plated
 Modularer Verteiler aus Pressmessing, Stützen-Abstand 38 mm, AG/IG 3/4" - 1"; vernickelt
 Collecteur pré-assemblé en laiton Entraxe 38 mm M/F 3/4" - 1"; nickelé
 Модульный никелированный коллектор из штампованной латуни. Соединение Н/В 3/4" - 1", межосевое расстояние 38 мм.

IVR 872

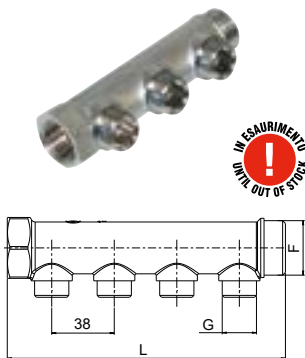

Collettori con attacchi M 1/2"
 M 1/2" connections
 Anschlüsse AG 1/2"
 Fixation M 1/2"
 Коллекторы с соединениями Н 1/2"

| Cod./Code | (F) Misura/Size | (G) Attacco/Connection | Vie/Ways | L(mm) | □/田 | € |
|-----------|-----------------|------------------------|----------|-------|-------|-------|
| 187211302 | 3/4" | 1/2" | 2 | 90 | 10/60 | 6,99 |
| 187211303 | 3/4" | 1/2" | 3 | 128 | 10/60 | 10,01 |
| 187211304 | 3/4" | 1/2" | 4 | 166 | 10/60 | 12,97 |
| 187221302 | 1" | 1/2" | 2 | 96 | 10/60 | 8,15 |
| 187221303 | 1" | 1/2" | 3 | 131 | 10/60 | 11,32 |
| 187221304 | 1" | 1/2" | 4 | 169 | 10/40 | 15,22 |

IVR 873

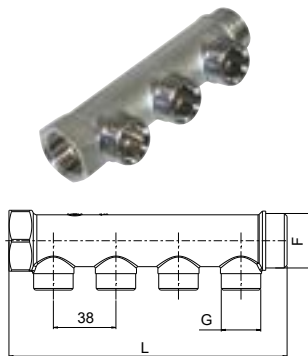

Collettori con attacchi M 24-19
 M 24-19 connections
 Anschlüsse AG M 24-19
 Fixation M 24-19
 Коллекторы с соединениями Н 24-19

| Cod./Code | (F) Misura/Size | (G) Attacco/Connection | Vie/Ways | L(mm) | □/田 | € |
|-----------|-----------------|------------------------|----------|-------|-------|-------|
| 187311302 | 3/4" | 24-19 | 2 | 90 | 10/60 | 7,27 |
| 187311303 | 3/4" | 24-19 | 3 | 128 | 10/60 | 10,04 |
| 187311304 | 3/4" | 24-19 | 4 | 166 | 10/60 | 13,00 |
| 187321302 | 1" | 24-19 | 2 | 96 | 10/60 | 8,22 |
| 187321303 | 1" | 24-19 | 3 | 131 | 10/60 | 11,32 |
| 187321304 | 1" | 24-19 | 4 | 169 | 10/40 | 15,22 |

IVR 874

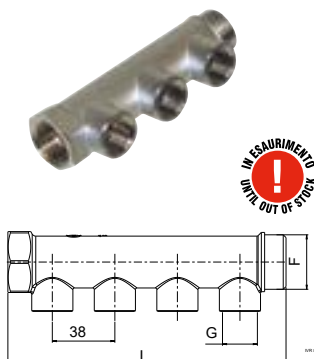

Collettori con attacchi F 1/2"
 F 1/2" connections
 Anschlüsse IG 1/2"
 Fixation F 1/2"
 Коллекторы с соединениями В 1/2"

| Cod./Code | (F) Misura/Size | (G) Attacco/Connection | Vie/Ways | L(mm) | □/田 | € |
|-----------|-----------------|------------------------|----------|-------|-------|-------|
| 187411302 | 3/4" | 1/2" | 2 | 90 | 10/60 | 6,90 |
| 187411303 | 3/4" | 1/2" | 3 | 128 | 10/60 | 9,81 |
| 187411304 | 3/4" | 1/2" | 4 | 166 | 10/60 | 12,88 |
| 187421302 | 1" | 1/2" | 2 | 96 | 10/60 | 8,15 |
| 187421303 | 1" | 1/2" | 3 | 131 | 10/60 | 11,32 |
| 187421304 | 1" | 1/2" | 4 | 169 | 10/40 | 15,22 |

IVR 858

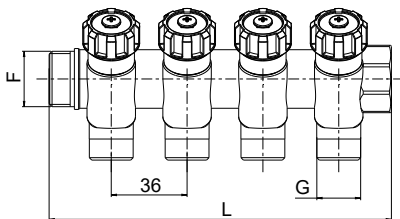

Collettori componibili stampati in ottone con rubinetti d'intercettazione - interasse 36 mm - M/F 3/4" - derivazioni M 1/2" - nichelato

Modular manifolds forged brass with stop cocks - outlet distance 36 mm - M/F 3/4" - with M 1/2" connection - nickel-plated

Modulare Verteiler aus Pressmessing mit Absperrventilen - Stützen-Abstand 36 mm - AG/IG 3/4" - Ableitung AG 1/2" - vernickelt

Collecteurs modulables estampés en laiton avec robinets de sectionnement - entraxe 36 mm - M/F 3/4" - Fixation M 1/2" - nickelé

Модульные никелированные коллекторы из штампованной латуни с запорными клапанами - межосевое расстояние 36мм - Н/В 3/4" - отводы Н 1/2"-никелированные

| Cod./Code | (F) Misura/Size | (G) Attacco/Connection | Vie/Ways | L(mm) | □/田 | € |
|-----------|-----------------|------------------------|----------|-------|-------|-------|
| 185811202 | 3/4" | 1/2" | 2 | 92 | 10/60 | 15,86 |
| 185811203 | 3/4" | 1/2" | 3 | 128 | 10/40 | 22,88 |
| 185811204 | 3/4" | 1/2" | 4 | 164 | 10/40 | 29,74 |

Collettori componibili stampati in ottone con rubinetti d'intercettazione - interasse 36 mm - M/F 1" - derivazioni M 1/2" - nichelato

Modular manifolds forged brass with stop cocks - outlet distance 36 mm - M/F 1" - with M 1/2" connection - nickel-plated

Modulare Verteiler, aus Pressmessing mit Absperrventilen - Abstand 36 mm - AG/IG 1" - Ableitung AG 1/2" - vernickelt

Collecteurs modulables estampés en laiton avec robinets de sectionnement - entraxe 36 mm - M/F 1" - fixation M 1/2" - nickelé

Модульные никелированные коллекторы из штампованной латуни с запорными клапанами - межосевое расстояние 36мм - Н/В 1" - отводы Н 1/2"-никелированные

| Cod./Code | (F) Misura/Size | (G) Attacco/Connection | Vie/Ways | L(mm) | □/田 | € |
|-----------|-----------------|------------------------|----------|-------|-------|-------|
| 185821202 | 1" | 1/2" | 2 | 103 | 10/60 | 21,94 |
| 185821203 | 1" | 1/2" | 3 | 139 | 10/40 | 31,31 |
| 185821204 | 1" | 1/2" | 4 | 175 | 10/40 | 41,18 |

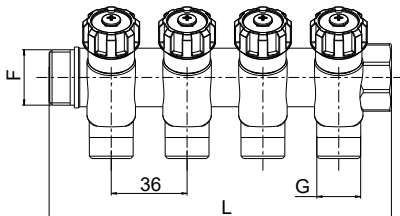

Collettori componibili stampati in ottone con rubinetti d'intercettazione - interasse 36 mm - M/F 3/4" - derivazioni M 24-19 - nichelato

Modular manifolds forged brass with stop cocks - outlet distance 36 mm - M/F 3/4" - with M 24-19 connection - nickel-plated

Modulare Verteiler, aus Pressmessing mit Absperrventilen - Stützen-Abstand 36 mm - AG/IG 3/4" - Ableitung AG 24-19 - vernickelt

Collecteurs modulables estampés en laiton avec robinets de sectionnement - entraxe 36 mm - M/F 3/4" - Fixations M 24-19 - nickelé

Модульные никелированные коллекторы из штампованной латуни с запорными клапанами - межосевое расстояние 36мм - Н/В 3/4"- отводы Н 24-19-никелированные

| Cod./Code | (F) Misura/Size | (G) Attacco/Connection | Vie/Ways | L(mm) | □/田 | € |
|-----------|-----------------|------------------------|----------|-------|-------|-------|
| 185813202 | 3/4" | 24-19 | 2 | 92 | 10/60 | 16,20 |
| 185813203 | 3/4" | 24-19 | 3 | 128 | 10/40 | 23,18 |
| 185813204 | 3/4" | 24-19 | 4 | 164 | 10/40 | 30,49 |

Collettori componibili stampati in ottone con rubinetti d'intercettazione - interasse 36 mm - M/F 1" - derivazioni M 24-19 - nichelato

Modular manifolds forged brass with stop cocks - outlet distance 36 mm - M/F 1" - with M 24-19 connection - nickel-plated

Modulare Verteiler aus Pressmessing mit Absperrventilen - Stützen-Abstand 36 mm - IG/AG 1" - Ableitung AG 24-19 - vernickelt

Collecteurs modulables estampés en laiton avec robinets de sectionnement - entraxe 36 mm - M/F 1" - Fixations M 24-19 - nickelé

Модульные никелированные коллекторы из штампованной латуни с запорными клапанами - межосевое расстояние 36мм - Н/В 1" - отводы Н 24-19 - никелированные

| Cod./Code | (F) Misura/Size | (G) Attacco/Connection | Vie/Ways | L(mm) | □/田 | € |
|-----------|-----------------|------------------------|----------|-------|-------|-------|
| 185823202 | 1" | 24-19 | 2 | 103 | 10/60 | 22,58 |
| 185823203 | 1" | 24-19 | 3 | 139 | 10/40 | 31,88 |
| 185823204 | 1" | 24-19 | 4 | 175 | 10/40 | 41,89 |

COLLETTORI / MANIFOLDS ACCESSORI / ACCESSORIES

IVR 580



Adattatori preassemblati per tubo rame - Nichelato
Adapters preassembled for copper pipe - Nickel plated
Vormontierter Adapter / Zwischenstücke für Kupferrohr - Vernickelt
Adaptateurs préassemblés pour tubes en cuivre - Niklé
Собранный адаптер для медной трубы - никелированный

| Cod./Code | Misura/Size | Attacco/Connection | □/田 | € |
|-----------|-------------|--------------------|--------|------|
| 158005100 | 10 | 1/2" | 20/400 | 3,00 |
| 158005120 | 12 | 1/2" | 20/400 | 1,88 |
| 158005140 | 14 | 1/2" | 20/400 | 2,21 |
| 158005150 | 15 | 1/2" | 20/400 | 1,95 |
| 158005160 | 16 | 1/2" | 20/400 | 2,21 |
| 158024100 | 10 | 24-19 | 20/400 | 2,74 |
| 158024120 | 12 | 24-19 | 20/400 | 2,10 |
| 158024140 | 14 | 24-19 | 20/300 | 2,60 |
| 158024150 | 15 | 24-19 | 20/300 | 2,14 |
| 158024160 | 16 | 24-19 | 20/400 | 2,14 |
| 158024180 | 18 | 24-19 | 20/400 | 2,21 |
| 158007120 | 12 | 3/4" EK | 20/300 | 2,66 |
| 158007140 | 14 | 3/4" EK | 20/300 | 2,63 |
| 158007150 | 15 | 3/4" EK | 20/300 | 3,23 |
| 158007160 | 16 | 3/4" EK | 20/300 | 2,25 |
| 158007180 | 18 | 3/4" EK | 20/300 | 2,36 |

IVR 581



Adattatori universali a compressione per tubi multistrato e polietilene reticolato PEX, nichelati - Nickelato
Adapters for multilayer pipe and cross-linked polyethylene pipe PEX, nickel plated - Nickel plated
Universal-Adaptern-Zwischenstücke für Mehrschichtrohren und aus vernetztem und vernickeltem Polyethylen PEX - vernickelt

Adaptateurs universels à compression pour tubes multicouche et polyéthylène réticulé PEX - nickelés - nichelés

Никелированные универсальные компрессионные адаптеры для металлопластиковых труб ,труб из сшитого полиэтилена PEX, никелированных труб

| Cod./Code | Misura/Size | Attacco/Connection | □/田 | € |
|-----------|-------------|--------------------|--------|------|
| 158105143 | 14 x 2 | 1/2" | 20/400 | 2,06 |
| 158105156 | 15 x 2,5 | 1/2" | 20/400 | 2,06 |
| 158105163 | 16 x 2 | 1/2" | 20/300 | 2,21 |
| 158105164 | 16 x 2,25 | 1/2" | 20/400 | 2,59 |
| 158124143 | 14 x 2 | 24-19 | 20/400 | 3,56 |
| 158124156 | 15 x 2,5 | 24-19 | 20/400 | 2,35 |
| 158124163 | 16 x 2 | 24-19 | 20/400 | 2,35 |
| 158124164 | 16 x 2,25 | 24-19 | 20/400 | 2,35 |
| 158124173 | 17 x 2 | 24-19 | 20/400 | 3,00 |
| 158124183 | 18 x 2 | 24-19 | 20/400 | 2,85 |
| 158124203 | 20 x 2 | 24-19 | 20/300 | 3,68 |
| 158107143 | 14 x 2 | 3/4" EK | 20/240 | 2,35 |
| 158107163 | 16 x 2 | 3/4" EK | 20/300 | 2,26 |
| 158107173 | 17 x 2 | 3/4" EK | 20/300 | 4,01 |
| 158107183 | 18 x 2 | 3/4" EK | 20/300 | 4,65 |
| 158107203 | 20 x 2 | 3/4" EK | 20/300 | 3,60 |
| 158110203 | 20 x 2 | 1" | 10/150 | 3,28 |
| 158110255 | 25 x 2,3 | 1" | 10/150 | 4,14 |
| 158110256 | 25 x 2,5 | 1" | 10/150 | 4,05 |
| 158110268 | 26 x 3 | 1" | 10/80 | 4,05 |

IVR 830 CASSETTE METALLICHE



Armadio universale in acciaio zincato in lamiera preverniciata RAL 9010 per alloggiamento collettore. Include: base incasso, 2 kit guide regolabili, 2 piedini regolabili (regolazione consentita: da 0 a 100 mm), frontalino con rete elettrosaldata anche sul dorso per facilitare l'aggrappaggio dell'intonaco; porta e cornice in lamiera preverniciata RAL 9010 regolabile in profondità (regolazione consentita: da 0 a 50 mm)

Universal galvanised steel cabinet in pre-varnished sheet metal RAL 9010 designed to house the manifold. It includes: base for jointing, nr. 2 adjustable feet (allowed adjustment from 0 to 100mm), plastering and removal soaking front, net electrically welded to make plastering easier; door and frame in pre-varnished sheet metal RAL 9010 with adjustable depth (from 0 to 50 mm).

Universalschrank aus verzinktem rostfreiem Stahl aus lackierte Metallschicht RAL 9010 für Verteiler. Ausgestattet mit: Fuss für Montage, 2 Kits von verstellbaren Führungsschienen, 2 verstellbaren Füßchen (von 0 bis zum 100mm), elektrogeschweißtem Netz vorne und hinten zu einem guten Verputzen; Tur und Rahmen aus lackierter Metallschicht RAL 9010 mit verstellbarer Tiefe (von 0 bis zum 50 mm).

Armoire universel en acier galvanisé en tôle avec une couche de vernis RAL 9010 pour mettre le collecteur. Il inclut: la base pour le montage, 2 kits de coulisseaux réglables, 2 pieds réglables (de 0 à 100 mm), une grille électrosoudée arrière et derrière faciliter l'accrochage de l'enduit; porte et corniche en tôle avec une couche de vernis RAL 9010 avec la profondeur réglable (de 0 à 50 mm).

Универсальный шкаф из оцинкованной стали с полимерным покрытием RAL 9010 предназначен для монтажа коллекторов. Состоит из: основа для монтажа, 2 набора монтажных регулируемых реек, 2 регулируемые ножки (позволенная регулировка по высоте от 0 до 100мм), стенки шкафа и сетка для монтажа электросваривания, а также задняя панель для облегчения адгезии строительной штукатурки, выдвигающая рамка с дверцей окрашены RAL 9010 позволяет регулировать глубину установки (позволенная регулировка: от 0 до 50 мм)

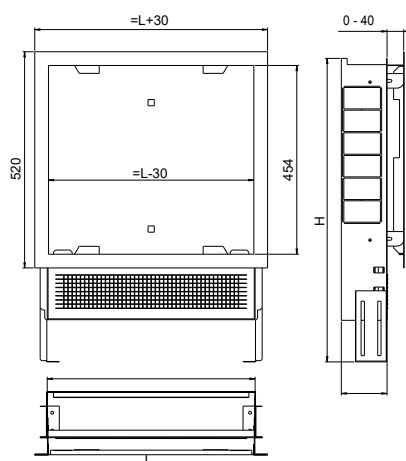

| Cod./Code | L(mm) | H(mm) | P(mm) | MAX | □/田 | € |
|------------|-------|------------------|-------|-------|-----|--------|
| 1830040009 | 400 | min. 630 max 730 | 90 | 3+3 | 1 | 87,83 |
| 1830050009 | 500 | min. 630 max 730 | 90 | 5+5 | 1 | 93,83 |
| 1830060009 | 600 | min. 630 max 730 | 90 | 7+7 | 1 | 106,58 |
| 1830070009 | 700 | min. 630 max 730 | 90 | 9+9 | 1 | 114,41 |
| 1830085009 | 850 | min. 630 max 730 | 90 | 12+12 | 1 | 136,80 |
| 1830100009 | 1000 | min. 630 max 730 | 90 | 13+13 | 1 | 154,39 |
| 1830120009 | 1200 | min. 630 max 730 | 90 | | 1 | 173,70 |
| 1830130009 | 1300 | min. 630 max 730 | 90 | | 1 | 185,74 |
| 183004001 | 400 | min. 630 max 730 | 110 | 3+3 | 1 | 88,91 |
| 1830050011 | 500 | min. 630 max 730 | 110 | 5+5 | 1 | 94,84 |
| 183006001 | 600 | min. 630 max 730 | 110 | 7+7 | 1 | 107,78 |
| 183007001 | 700 | min. 630 max 730 | 110 | 9+9 | 1 | 115,54 |
| 1830085011 | 850 | min. 630 max 730 | 110 | 12+12 | 1 | 137,93 |
| 183010001 | 1000 | min. 630 max 730 | 110 | 13+13 | 1 | 155,63 |
| 183012001 | 1200 | min. 630 max 730 | 110 | | 1 | 174,79 |
| 1830130011 | 1300 | min. 630 max 730 | 110 | | 1 | 186,83 |
| 1830040015 | 400 | min. 630 max 730 | 150 | 3+3 | 1 | 95,70 |
| 1830050015 | 500 | min. 630 max 730 | 150 | 5+5 | 1 | 103,09 |
| 1830060015 | 600 | min. 630 max 730 | 150 | 7+7 | 1 | 114,26 |
| 1830070015 | 700 | min. 630 max 730 | 150 | 9+9 | 1 | 122,81 |
| 1830085015 | 850 | min. 630 max 730 | 150 | 12+12 | 1 | 144,75 |
| 1830100015 | 1000 | min. 630 max 730 | 150 | 13+13 | 1 | 163,09 |
| 1830120015 | 1200 | min. 630 max 730 | 150 | | 1 | 182,74 |
| 1830130015 | 1300 | min. 630 max 730 | 150 | | 1 | 195,83 |

IVR 831 CASSETTE PLASTICHE



Cassetta in plastica universale per collettori, con set supporto collettori; per IVR 872-873-874

Plastic cabinet, with manifolds mounting set; for IVR 872-873-874

Universalgehäuse aus Plastik für Verteiler, mit Verteilerhalterungsset; für IVR 872-873-874

Cassette en plastique universelle pour collecteurs, avec set support collecteurs; pour IVR 872-873-874

Универсальный пластиковый шкаф с монтажным набором - для коллекторов IVR 872-873-874

| Cod./Code | Misura/Size | MAX | □/田 | € |
|-----------|----------------|-----|------|-------|
| 183103201 | 320 x 265 x 80 | 4 | 1/10 | 23,55 |
| 183104001 | 400 x 265 x 80 | 7 | 1/10 | 26,63 |
| 183105001 | 500 x 265 x 80 | 9 | 1/10 | 30,60 |
| 183106001 | 600 x 265 x 80 | 11 | 1/10 | 36,38 |

IVR 360 AIRVENT AUTO



Valvola automatica di sfogo aria Ø 42 sfogo aria superiore, nichelata
 Automatic air-vent nickel-plated - Ø 42 top air-vent
 Automatisches Entlüftungsventil vernickelt - Ø 42 - Entlüftung oben -
 Vanne automatique purgeur d'air nickelée - Ø 42 vanne automatique de purge supérieure
 Автоматический воздухоотводчик ,никелированный - Ø 42 - воздухоотвод вертикальный

| Cod./Code | Misura/Size | □/田 | € |
|-----------|-------------|-------|------|
| 136003001 | 3/8" | 16/64 | 6,81 |
| 136005001 | 1/2" | 16/64 | 6,81 |
| 136007001 | 3/4" | 16/64 | 6,81 |

IVR 361



Valvola automatica di sfogo aria Ø 39 attacco laterale, nichelata
 Automatic air-vent nickel-plated - Ø 39 side connection
 Automatisches Entlüftungsventil vernickelt - Ø 39 - mit seitlichem Außenanschlussgewinde
 Vanne automatique purgeur d'air nickelée - Ø 39 fixation lateral
 Автоматический воздухоотводчик, никелированный - Ø 39 с боковым подключением

| Cod./Code | Misura/Size | □/田 | € |
|-----------|-------------|-------|------|
| 136103001 | 3/8" | 10/60 | 7,73 |
| 136105001 | 1/2" | 10/60 | 7,73 |

IVR 816



Valvola automatica di sfogo aria, sfogo aria laterale, nichelata
 Automatic air-vent, side air-vent, nickel-plated
 Automatisches Entlüftungsventil vernickelt - Entlüftung seitlich
 Vanne automatique purgeur d'air nickelée - purgeur d'air lateral
 Автоматический воздухоотводчик никелированный - воздухоотвод боковой

| Cod./Code | Misura/Size | □/田 | € |
|-----------|-------------|-------|------|
| 181603001 | 3/8" | 16/64 | 6,81 |

IVR 832



Valvola automatica di sfogo aria Ø 50 sfogo aria superiore, nichelata
 Automatic air-vent, Ø 50 top air-vent, nickel-plated
 Automatisches Entlüftungsventil vernickelt - Ø 50 - Entlüftung oben -
 Vanne automatique purgeur d'air nickelée - Purge d'air Ø 50 supérieur
 Автоматический воздухоотводчик никелированный - Ø 50 - воздухоотвод вертикальный

| Cod./Code | Misura/Size | □/田 | € |
|-----------|-------------|-------|------|
| 183203001 | 3/8" | 10/60 | 7,29 |
| 183205001 | 1/2" | 10/60 | 7,29 |

IVR 364



Tappo per radiatori con valvola automatica di sfogo aria, nichelato
Automatic air-vent for radiators, nickel-plated - Automatic / nickel-plated
Entlüftungsventil für Heizkörper vernickelt - Automatisches Entlüftung
Vanne purgeur d'air pour radiateur - automatique / nickelée
Заглушка для радиаторов с никелированным автоматическим воздухоотводчиком

| Cod./Code | Misura/Size | □/田 | € |
|-----------|-------------|-------|------|
| 136410001 | 1" DX | 10/50 | 6,81 |
| 136410002 | 1" SX | 10/50 | 6,81 |
| 136412001 | 1"1/4 DX | 10/60 | 8,27 |
| 136412002 | 1"1/4 SX | 10/60 | 8,27 |

IVR 367



Valvola sfogo aria per radiatori manuale, nichelata
Automatic air-vent for radiators, Nickel-plated - Manual / Nickel-plated
Entlüftungsventil für Heizkörper vernickelt, - Manuelles Entlüftung
Vanne purgeur d'air pour radiateur - manuel / nickelée
Воздухоотводчик для радиаторов , ручной , никелированный

| Cod./Code | Misura/Size | □/田 | € |
|-----------|-------------|----------|------|
| 136702001 | 1/4" | 100/1000 | 0,83 |
| 136703001 | 3/8" | 100/800 | 1,05 |
| 136705001 | 1/2" | 75/450 | 1,44 |

IVR 833



Valvola sfogo aria per radiatori manuale con tenuta P.T.F.E. nichelata
Automatic air-vent for radiators, nickel-plated - Manual with P.T.F.E. seal
Entlüftungsventil für Heizkörper vernickelt - Manuelles Entlüftung - mit P.T.F.E. - Dichtung
Vanne purgeur d'air pour radiateur, nickelée - Vanne manuelle avec tenue en P.T.F.E.
Воздухоотводчик для радиаторов, ручной, никелированный с уплотнением P.T.F.E.

| Cod./Code | Misura/Size | □/田 | € |
|-----------|-------------|---------|------|
| 183303001 | 3/8" | 100/600 | 1,19 |
| 183305001 | 1/2" | 50/600 | 1,63 |

IVR 837



Rubinetto d'intercettazione per valvola automatica di sfogo aria
Interception valve for automatic air vent
Absperrventil für automatisches Entlüftungsventil
Robinet de sectionnement pour la vanne de purge de l'air
Отсекающий кран для автоматического воздухоотводчика

| Cod./Code | Misura/Size | □/田 | € |
|-----------|-------------|--------|------|
| 183703031 | 3/8" x 3/8" | 50/900 | 1,17 |
| 183703051 | 3/8" x 1/2" | 50/750 | 1,95 |
| 183705051 | 1/2" x 1/2" | 50/750 | 1,54 |

IVR 838



Valvola sfogo aria per radiatore manuale / orientabile, nichelata
 Automatic air-vent for radiators, nickel-plated - Manual / Orientable
 Entlüftungsventil für Heizkörper vernickelt, - Manuelles Entlüftung - einstellbar
 Vanne purgeur d'air pour radiateur, nickelée - Vanne manuelle de purge d'air orientable
 Воздухоотводчик для радиаторов, никелированный - ручной / регулируемый

| Cod./Code | Misura/Size | □/田 | € |
|-----------|-------------|----------|------|
| 183803001 | 3/8" | 100/1200 | 1,13 |
| 183805001 | 1/2" | 100/1200 | 1,13 |

IVR 836 DRAIN



Rubinetto orientabile di carico-scarico
 Water fill & drain valve
 Ausrichtbares Ein-/Ablassventil von Wasser
 Robinet orientable de chargement/déchargement de l'eau
 Регулируемый дренажный клапан

| Cod./Code | Misura/Size | □/田 | € |
|-----------|-------------|--------|------|
| 183605001 | 1/2" | 10/120 | 5,28 |

IVR 836/I DRAIN

NEW



Rubinetto orientabile di carico-scarico
 Drain valve
 Ausrichtbares Wasserfüllung und-Entleerungshahn
 Robinet orientable de chargement/évacuation eau
 Регулируемый уклонный дренажный клапан

| Cod./Code | Misura/Size | □/田 | € |
|-----------|-------------|--------|------|
| 183605100 | 1/2" | 10/120 | 4,14 |

IVR 836/P DRAIN

NEW



Rubinetto orientabile inclinato di carico-scarico in tecnopolimero
 Rotating angle fill & drain valve in technopolymer
 Drehbares Ein-/Anlassventil aus Technopolymere
 Robinet orientable de chargement/déchargement en technopolymère
 Регулируемый уклонный дренажный клапан из технополимера



| Cod./Code | Misura/Size | □/田 | € |
|-----------|-------------|--------|------|
| 183605150 | 1/2" | 10/120 | 2,66 |



IVR 411 RACCORDI TERMINALI



Raccordo terminale M con autotenuta, nichelato
Manifold plug. Nickel-plated - M with auto-seal
Endanschluss. Vernickelt - AG mit Selbstdichtung
Raccord terminal. Nickelé - M avec auto-étanche
Концевое никелированное соединение для коллектора с наружной резьбой и самогерметизацией

| Cod./Code | Misura/Size | □/田 | € |
|-----------|-----------------------|--------|------|
| 141107531 | 3/4" M x 1/2" x 3/8" | 10/180 | 4,45 |
| 141110531 | 1" M x 1/2" x 3/8" | 10/180 | 5,70 |
| 141112531 | 1"1/4 M x 1/2" x 3/8" | 10/160 | 6,00 |

IVR 408



Raccordo terminale M con autotenuta e dado, nichelato
Manifold plug. Nickel-plated - M with Auto-seal and nut
Endanschluss - vernickelt - AG - mit Selbstdichtung und Überwurfmutter
Raccord Terminal, nickelé - M avec joint et écrou
Концевое никелированное соединение для коллектора с наружной резьбой, гайкой и самогерметизацией

| Cod./Code | Misura/Size | □/田 | € |
|-----------|---------------------------------|--------|------|
| 140810551 | 1" x 1/2" x 1/2" TERM MAS C/GHI | 15/180 | 5,37 |

IVR 405 NIPLO



Nipples con autotenuta, nichelato
Nickel-plated auto-seal nipples
Vernickeltes Nippel mit Selbstdichtung
Raccords avec auto-étanche nickelés
Ниппель с самогерметизацией, никелированный

| Cod./Code | Misura/Size | □/田 | € |
|-----------|-------------|--------|------|
| 140507001 | 3/4" | 10/240 | 4,39 |
| 140510001 | 1" | 25/150 | 4,35 |
| 140512001 | 1"1/4 | 10/180 | 6,49 |

IVR 407 NIPLO



Niples orientabile con autotenuta, nichelato
 Nickel-plated rotatable nipple with auto-seal
 Drehbares vernickeltes Nippel mit Selbstdichtung
 Raccords orientables avec auto-étanche nickelés
 Регулируемый ниппель с самогерметизацией, никелированный

| Cod./Code | Misura/Size | □/田 | € |
|-----------|-------------|--------|-------|
| 140710001 | 1" | 10/180 | 7,76 |
| 140712001 | 1"1/4 | 10/120 | 12,53 |

IVR 311



Raccordo in tre pezzi con autotenuta e sede conica, dritto, nichelato
 Three-piece fitting with auto seal. Nickel-plated - straight. Conical seat
 Dreiteiliger Anschluss mit Selbstdichtung. Vernickelt - gerade. Kegelsitz
 Raccord en trois pièces avec auto-étanche. Nickelé - droit. Siège conique
 Трехсоставной фитинг с самогерметизацией, никелированный - прямой с коническим седлом

| Cod./Code | Misura/Size | □/田 | € |
|-----------|-------------|--------|-------|
| 131107001 | 3/4" | 10/120 | 16,16 |
| 131110001 | 1" | 10/40 | 22,58 |

IVR 316



Raccordo in tre pezzi con autotenuta e sede conica, a gomito, nichelato
 Three pieces fitting with auto seal. Nickel-plated - elbow
 Dreiteiliger winkel Anschluss - selbstdichtend - vernickelt
 Raccord trois pièces autoétanche, nickelé - Courbé
 Трехсоставной фитинг с самогерметизацией, никелированный с коническим седлом, согнут под прямым углом

| Cod./Code | Misura/Size | □/田 | € |
|-----------|-------------|-------|-------|
| 131607001 | 3/4" | 10/80 | 14,59 |
| 131610001 | 1" | 10/40 | 16,91 |

IVR 896



Set collegamento (4 pezzi) per AVANT FLOOR
 Connection set (4 pcs) for AVANT FLOOR
 Anschlussgarnitur (4 Stk.) für AVANT FLOOR
 Kit connexion (4 pièces) pour AVANT FLOOR
 Комплект содинений (4 шт) для коллекторов AVANT FLOOR

| Cod./Code | Misura/Size | □/田 | € |
|-----------|-------------|-------|-------|
| 189610101 | 1" x 1" | 10/40 | 15,67 |

IVR 412



Tappo F - nichelato
 F plug - Nickel-plated
 Deckel IG - vernickelt
 Bouchon F nickelé
 Никелированная заглушка с внутренней резьбой

| Cod./Code | Misura/Size | □/田 | € |
|-----------|-------------|---------|------|
| 141204001 | 24 - 19 | 50/900 | 2,34 |
| 141205001 | 1/2" | 50/1200 | 1,78 |
| 141207001 | 3/4" | 50/900 | 2,11 |
| 141210001 | 1" | 25/450 | 2,78 |
| 141212001 | 1" x 1/4" | 20/200 | 3,28 |



IVR 414



Tappo M per collettore nichelato
M plug for manifolds IVR 893. Nickel-plated
Deckel AG für IVR 893. Vernickelt
Bouchon M pour IVR 893. Nickelé
Никелированная заглушка с наружной резьбой для коллекторов

| Cod./Code | Misura/Size | □/田 | € |
|-----------|-------------|---------|-------|
| 141405001 | 1/2" | 50/1200 | 1,04 |
| 141407001 | 3/4" | 50/900 | 1,66 |
| 141410001 | 1" | 50/600 | 1,69 |
| 141412001 | 1"1/4 | 50/300 | 4,36 |
| 141420001 | 2" | 10/60 | 16,48 |

IVR 415



Riduzione M/F nichelata
M/F open plug. Nickel-plated
Deckel AG/IG. Vernickelt
Bouchon M/F. Nickelé
Переходник Н/В, никелированный

| Cod./Code | Misura/Size | □/田 | € |
|-----------|------------------|--------|------|
| 141507031 | 3/4" M x 3/8" F | 50/900 | 1,61 |
| 141507051 | 3/4" M x 1/2" F | 50/900 | 1,69 |
| 141510031 | 1" M x 3/8" F | 50/300 | 2,89 |
| 141510051 | 1" M x 1/2" F | 50/300 | 2,74 |
| 141510071 | 1" M x 3/4" F | 50/300 | 2,63 |
| 141512051 | 1"1/4 M x 1/2" F | 50/300 | 5,33 |
| 141512101 | 1"1/4 M x 1" F | 50/300 | 4,20 |

IVR 829

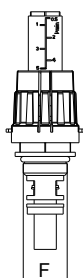

Misuratore di portata in ottone
Flow meter in brass
Durchflussmesser aus Messing
Mesureur de débit en laiton
Расходомер из латуни

| Cod./Code | Misura/Size | F | □/田 | € |
|-----------|-------------------------------------|------|-------|------|
| 182910105 | 0,5 ÷ 5 l/min - per/for AVANT FLOOR | 1/2" | 15/60 | 7,41 |
| 182910108 | 0,5 ÷ 8 l/min - per/for AVANT FLOOR | 1/2" | 15/60 | 7,45 |

IVR 829/P

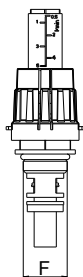

Misuratore di portata in tecnopolimero
Flow meter in technopolymer
Durchflussmesser aus Technopolymer
Mesureur de débit en technopolymère
Расходомер из технополимера

| Cod./Code | Misura/Size | F | □/田 | € |
|-----------|-------------------------------------|------|-------|------|
| 182910155 | 0,5 ÷ 5 l/min - per/for AVANT FLOOR | 1/2" | 15/60 | 6,70 |

IVR MULTIKLIMA 483



Dimensioni - Sizes - Maßen - Fixation - Размеры:
H = 550 mm • L = 550 mm • P = 110-150 mm

Modulo IVR MULTIKLIMA 483 con valvola 3 vie con by pass, bilanciamento statico e miscelatore ACS/AFS
IVR MULTIKLIMA 483 Metering unit - with 3-way valve with by-pass, static balancing valve and HSW/CSW mixing valve

IVR MULTIKLIMA 483 Zählermodul mit 3-Wege Kugelhahn mit Bypass, statischem Ausgleich und Warm oder-Kaltwassermischung

IVR MULTIKLIMA 483 Module pour la comptabilisation avec vanne à 3 voies avec by-pass, vanne d'équilibrage statique et mitigeur ECS/EFS

IVR MULTIKLIMA 483 - Узел учета с трёхходовым клапаном с бай-пассом, статическим балансировочным и смесительным клапаном ГВС/ХВС



IVR MULTIKLIMA 483 PLUS

Modulo IVR MULTIKLIMA 483 PLUS con linea per acqua di servizio

IVR MULTIKLIMA 483 PLUS Metering Set with additional grey water line

IVR MULTIKLIMA 483 PLUS Zählermodul mit zusätzlicher Nutzwasserleitung

IVR MULTIKLIMA 483 PLUS Module pour la comptabilisation avec la ligne additionnelle de l'eau de récupération

IVR MULTIKLIMA 483 Plus с линией дополнительной подачи для технической воды

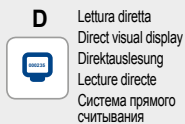

D Lettura diretta
Direct visual display
Direktauslesung
Lecture directe
Система прямого считывания

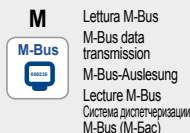

M Lettura M-Bus
M-Bus data transmission
M-Bus-Auslesung
Lecture M-Bus
Система диспетчеризации M-Bus (M-Бас)

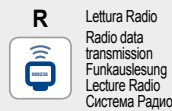

R Lettura Radio
Radio data transmission
Funkauslesung
Lecture Radio
Система Радио

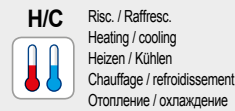

H/C Risc. / Raffresc.
Heating / cooling
Heizen / Kühlen
Chauffage / refroidissement
Отопление / охлаждение

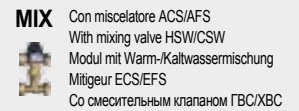

MIX Con miscelatore ACS/AFS
With mixing valve HSW/CSW
Modul mit Warm-Kaltwassermischung
Mitigeur ECS/EFS
Со смесительным клапаном ГВС/ХВС

COMPLETE DI MISURATORI - WITH FLOW METERS

| IVR 483 LINEE RISCALDAMENTO - HEATING RANGE | | | | | |
|---|----------|-----|---------------|---------------|--------|
| D/M/R | Q3 | H/C | COD. SX. LEFT | COD. DX RIGHT | € |
| D | 1,5 mc/h | H/C | M83D014G02 | M83D114G02 | 595,37 |
| D | 2,5 mc/h | H/C | M83D024G02 | M83D124G02 | 606,22 |
| M | 1,5 mc/h | H/C | M83M014G02 | M83M114G02 | 668,02 |
| M | 2,5 mc/h | H/C | M83M024G02 | M83M124G02 | 678,87 |
| R | 1,5 mc/h | H/C | M83R014G02 | M83R114G02 | 736,84 |
| R | 2,5 mc/h | H/C | M83R024G02 | M83R124G02 | 747,69 |

| IVR 400 LINEE SANITARIE - SANITARY HOT AND COLD WATER LINES | | | | |
|---|----------|------------|------------|--------|
| D/M/R | QP | AFS/ACS | CODICE | € |
| D | 2,5 mc/h | ACS/HSW | ML1D020G02 | 68,01 |
| D | 2,5 mc/h | AFS/CSW | ML0D020G02 | 55,39 |
| D | 2,5 mc/h | DUALE/GREY | ML4D020G02 | 55,39 |
| D | 2,5 mc/h | MIX | ML2D02MG02 | 261,50 |
| M | 2,5 mc/h | ACS/HSW | ML1M020G02 | 99,94 |
| M | 2,5 mc/h | AFS/CSW | ML0M020G02 | 91,33 |
| M | 2,5 mc/h | DUALE/GREY | ML4M020G02 | 91,33 |
| M | 2,5 mc/h | MIX | ML2M02MG02 | 329,37 |
| R | 2,5 mc/h | ACS/HSW | ML1R020G02 | 99,94 |
| R | 2,5 mc/h | AFS/CSW | ML0R020G02 | 91,33 |
| R | 2,5 mc/h | DUALE/GREY | ML4R020G02 | 91,33 |
| R | 2,5 mc/h | MIX | ML2R02MG02 | 329,51 |

SENZA MISURATORI CON TRONCHETTO SPAZIATORE - WITHOUT FLOW METERS WITH CONNECTION PIPES

| LINEE RISCALDAMENTO - HEATING RANGE | | | |
|-------------------------------------|-----|------------|--------|
| Q3 | H/C | COD. SX/DX | € |
| 3/4" F x 110 mm | H/C | M83B010A02 | 256,61 |
| 1" F x 130 mm | H/C | M83B020A02 | 259,05 |

| LINEE SANITARIE - SANITARY HOT AND COLD WATER LINES | | | |
|---|------------|------------|--------|
| QP | AFS/ACS | COD. SX/DX | € |
| 3/4" F x 110 mm | ACS/HSW | ML1B020G02 | 27,87 |
| 3/4" F x 110 mm | AFS/CSW | ML0B020G02 | 27,87 |
| 3/4" F x 110 mm | MIX | ML2B02MG02 | 197,26 |
| 3/4" F x 110 mm | DUALE/GREY | ML4B020G02 | 29,58 |

CASSETTE, ZANCHE, ARMADI MULTIUTENZA - CABINETS, BRACKETS, MULTI-USERS CABINETS

| IVR 409 CASSETTA / ZANCHE - CABINETS/BRACKETS | | | |
|---|------------|------------|--------|
| D/M/R | DIMENSIONI | COD. SX/DX | € |
| D/M | 550 X 550 | MB55027D01 | 220,34 |
| R | 550 X 550 | MB55027R01 | 233,20 |
| D/M | 650 X 550 | MB65027D01 | 302,91 |
| R | 650 X 550 | MB65027R01 | 315,00 |
| ZANCA | 350 X 550 | MB01527Z01 | 80,01 |
| ZANCA | 550 X 550 | MB05527Z01 | 153,11 |
| ZANCA | 650 X 550 | MB06527Z01 | 164,58 |

| CASSETTA MULTIUTENZA - MULTI-USER CABINETS | | | |
|--|---------------------|------------|---------|
| D/M/R | DIMENSIONI | COD. SX/DX | € |
| D/M | 2 UTENZE 1080 X 550 | MB72027D01 | 543,33 |
| R | 2 UTENZE 1080 X 550 | MB72027R01 | 586,74 |
| D/M | 3 UTENZE 1630 X 550 | MB73027D01 | 835,71 |
| R | 3 UTENZE 1630 X 550 | MB73027R01 | 900,82 |
| D/M | 4 UTENZE 2180 X 550 | MB74027D01 | 1079,63 |
| R | 4 UTENZE 2180 X 550 | MB74027R01 | 1166,44 |

IVR MULTIKLIMA 473



Dimensioni - Sizes - Maßen - Fixation - Размеры:
H = 550 mm • L = 550 mm • P = 110-150 mm

Modulo IVR MULTIKLIMA 473 - con valvola 3 vie con by pass e miscelatore ACS/AFS
IVR MULTIKLIMA 473 Metering Set - with 3 ways valve with by pass and mixing valve DHW/DCW
IVR MULTIKLIMA 473 Modul mit 3 Wege Kugelhahn mit Bypass und Warm-/Kaltwassermischung
IVR MULTIKLIMA 473 Module pour la comptabilisation avec vanne à 3 voies avec by-pass et mitigeur ECS/EFS
IVR MULTIKLIMA 473 Узел учета - с трехходовым клапаном, бай-пассом и смесительным клапаном ГВС/ХВС



IVR MULTIKLIMA 473 PLUS

Modulo IVR MULTIKLIMA 473 PLUS con linea per acqua di servizio
IVR MULTIKLIMA 473 PLUS Metering Set with additional grey water line
IVR MULTIKLIMA 473 PLUS Zählermodul mit zusätzlicher Nutzwasserleitung
IVR MULTIKLIMA 473 PLUS Module pour la comptabilisation avec la ligne additionnelle de l'eau de récupération
IVR MULTIKLIMA 473 Plus с линией дополнительной подачи для технической воды

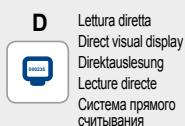

D Lettura diretta
Direct visual display
Direktauslesung
Lecture directe
Система прямого считывания

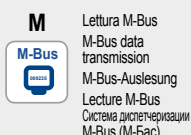

M Lettura M-Bus
M-Bus data transmission
M-Bus-Auslesung
Lecture M-Bus
Система диспечеризации M-Bus (M-Бас)



R Lettura Radio
Radio data transmission
Funkauslesung
Lecture Radio
Система Радио

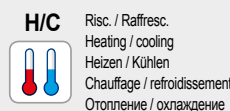

H/C Risc. / Raffresc.
Heating / cooling
Heizen / Kühlen
Chauffage / refroidissement
Отопление / охлаждение

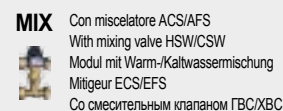

MIX Con miscelatore ACS/AFS
With mixing valve HSW/CSW
Modul mit Warm-/Kaltwassermischung
Mitigeur ECS/EFS
Со смесительным клапаном ГВС/ХВС

COMPLETE DI MISURATORI - WITH FLOW METERS

| IVR 473 LINEE RISCALDAMENTO - HEATING RANGE | | | | | |
|---|----------|-----|---------------|---------------|--------|
| D/M/R | Q3 | H/C | COD. SX. LEFT | COD. DX RIGHT | € |
| D | 1,5 mc/h | H/C | M73D014G02 | M73D114G02 | 520,74 |
| D | 2,5 mc/h | H/C | M73D024G02 | M73D124G02 | 531,59 |
| M | 1,5 mc/h | H/C | M73M014G02 | M73M114G02 | 593,39 |
| M | 2,5 mc/h | H/C | M73M024G02 | M73M124G02 | 604,24 |
| R | 1,5 mc/h | H/C | M73R014G02 | M73R114G02 | 662,21 |
| R | 2,5 mc/h | H/C | M73R024G02 | M73R124G02 | 673,06 |

| IVR 400 LINEE SANITARIE - SANITARY HOT AND COLD WATER LINES | | | | |
|---|----------|------------|------------|--------|
| D/M/R | QP | AFS/ACS | CODICE | € |
| D | 2,5 mc/h | ACS/HSW | ML1D020G02 | 68,01 |
| D | 2,5 mc/h | AFS/CSW | ML0D020G02 | 55,39 |
| D | 2,5 mc/h | DUALE/GREY | ML4D020G02 | 55,39 |
| D | 2,5 mc/h | MIX | ML2D02MG02 | 261,50 |
| M | 2,5 mc/h | ACS/HSW | ML1M020G02 | 99,94 |
| M | 2,5 mc/h | AFS/CSW | ML0M020G02 | 91,33 |
| M | 2,5 mc/h | DUALE/GREY | ML4M020G02 | 91,33 |
| M | 2,5 mc/h | MIX | ML2M02MG02 | 329,37 |
| R | 2,5 mc/h | ACS/HSW | ML1R020G02 | 99,94 |
| R | 2,5 mc/h | AFS/CSW | ML0R020G02 | 91,33 |
| R | 2,5 mc/h | DUALE/GREY | ML4R020G02 | 91,33 |
| R | 2,5 mc/h | MIX | ML2R02MG02 | 329,51 |

SENZA MISURATORI CON TRONCHETTO SPAZIATORE - WITHOUT FLOW METERS WITH CONNECTION PIPES

| LINEE RISCALDAMENTO - HEATING RANGE | | | |
|-------------------------------------|-----|------------|--------|
| Q3 | H/C | COD. SX/DX | € |
| 3/4" F x 110 mm | H/C | M73B010A02 | 181,98 |
| 1" F x 130 mm | H/C | M73B020A02 | 184,42 |

| LINEE SANITARIE - SANITARY HOT AND COLD WATER LINES | | | |
|---|------------|------------|--------|
| QP | AFS/ACS | COD. SX/DX | € |
| 3/4" F x 110 mm | ACS/HSW | ML1B020G02 | 27,87 |
| 3/4" F x 110 mm | AFS/CSW | ML0B020G02 | 27,87 |
| 3/4" F x 110 mm | MIX | ML2B02MG02 | 197,26 |
| 3/4" F x 110 mm | DUALE/GREY | ML4B020G02 | 29,58 |

CASSETTE, ZANCHE, ARMADI MULTIUTENZA - CABINETS, BRACKETS, MULTI-USERS CABINETS

| IVR 409 CASSETTA / ZANCHE - CABINETS/BRACKETS | | | |
|---|------------|------------|--------|
| D/M/R | DIMENSIONI | COD. SX/DX | € |
| D/M | 550 X 550 | MB55027D01 | 220,34 |
| R | 550 X 550 | MB55027R01 | 233,20 |
| D/M | 650 X 550 | MB65027D01 | 302,91 |
| R | 650 X 550 | MB65027R01 | 315,00 |
| ZANCA | 350 X 550 | MB01527Z01 | 80,01 |
| ZANCA | 550 X 550 | MB05527Z01 | 153,11 |
| ZANCA | 650 X 550 | MB06527Z01 | 164,58 |

| CASSETTA MULTIUTENZA - MULTI-USER CABINETS | | | |
|--|---------------------|------------|---------|
| D/M/R | DIMENSIONI | COD. SX/DX | € |
| D/M | 2 UTENZE 1080 X 550 | MB72027D01 | 543,33 |
| R | 2 UTENZE 1080 X 550 | MB72027R01 | 586,74 |
| D/M | 3 UTENZE 1630 X 550 | MB73027D01 | 835,71 |
| R | 3 UTENZE 1630 X 550 | MB73027R01 | 900,82 |
| D/M | 4 UTENZE 2180 X 550 | MB74027D01 | 1079,63 |
| R | 4 UTENZE 2180 X 550 | MB74027R01 | 1166,44 |

IVR MULTIKLIMA 482



Dimensioni - Sizes - Maßen - Fixation - Размеры:
H = 550 mm • L = 550 mm • P = 110-150 mm



Modulo IVR MULTIKLIMA 482 - con valvola 2 vie, bilanciamento statico e miscelatore ACS/AFS
IVR MULTIKLIMA 482 Metering Set - with 2 ways valve, static balancing valve and mixing valve DHW/DCW
IVR MULTIKLIMA 482 Modul mit 2 Wege Kugelhahn, statischem Ausgleich und Warm-/Kaltwasseremischung
Module IVR MULTIKLIMA 482 avec vanne 2 voies, vanne d'équilibrage statique et mitigeur ECS/EFS
IVR MULTIKLIMA 482 Узел учета - с двухходовым клапаном, статическим балансирующим клапаном и смесительным клапаном ГВС/ХВС

IVR MULTIKLIMA 482 PLUS

Modulo IVR MULTIKLIMA 482 PLUS con linea per acqua di servizio
IVR MULTIKLIMA 482 PLUS Metering Set with additional grey water line
IVR MULTIKLIMA 482 PLUS Zählermodul mit zusätzlicher Nutzwasserleitung
IVR MULTIKLIMA 482 PLUS Module pour la comptabilisation avec la ligne additionnelle de l'eau de récupération
IVR MULTIKLIMA 482 Plus с линией дополнительной подачи для технической воды

D Lettura diretta
Direct visual display
Direktauslesung
Lecture directe
Система прямого считывания

M Lettura M-Bus
M-Bus data transmission
M-Bus-Auslesung
Lecture M-Bus
Система диспетчеризации M-Bus (M-Бас)

R Lettura Radio
Radio data transmission
Funkauslesung
Lecture Radio
Система Радио

H/C Risc. / Raffresc.
Heating / cooling
Heizen / Kühlen
Chauffage / refroidissement
Отопление / охлаждение

MIX Con miscelatore ACS/AFS
With mixing valve HSW/CSW
Modul mit Warm-/Kaltwasseremischung
Mitigeur ECS/EFS
Со смесительным клапаном ГВС/ХВС

COMPLETE DI MISURATORI - WITH FLOW METERS

| IVR 482 LINEE RISCALDAMENTO - HEATING RANGE | | | | | |
|---|----------|-----|---------------|----------------|--------|
| D/M/R | Q3 | H/C | COD. SX. LEFT | COD. DX. RIGHT | € |
| D | 1,5 mc/h | H/C | M82D014G02 | M82D114G02 | 578,48 |
| D | 2,5 mc/h | H/C | M82D024G02 | M82D124G02 | 591,08 |
| M | 1,5 mc/h | H/C | M82M014G02 | M82M114G02 | 651,13 |
| M | 2,5 mc/h | H/C | M82M024G02 | M82M124G02 | 663,72 |
| R | 1,5 mc/h | H/C | M82R014G02 | M82R114G02 | 719,95 |
| R | 2,5 mc/h | H/C | M82R024G02 | M82R124G02 | 732,55 |

| IVR 400 LINEE SANITARIE - SANITARY HOT AND COLD WATER LINES | | | | |
|---|----------|------------|------------|--------|
| D/M/R | QP | AFS/ACS | CODICE | € |
| D | 2,5 mc/h | ACS/HSW | ML1D020G02 | 68,01 |
| D | 2,5 mc/h | AFS/CSW | ML0D020G02 | 55,39 |
| D | 2,5 mc/h | DUALE/GREY | ML4D020G02 | 55,39 |
| D | 2,5 mc/h | MIX | ML2D02MG02 | 261,50 |
| M | 2,5 mc/h | ACS/HSW | ML1M020G02 | 99,94 |
| M | 2,5 mc/h | AFS/CSW | ML0M020G02 | 91,33 |
| M | 2,5 mc/h | DUALE/GREY | ML4M020G02 | 91,33 |
| M | 2,5 mc/h | MIX | ML2M02MG02 | 329,37 |
| R | 2,5 mc/h | ACS/HSW | ML1R020G02 | 99,94 |
| R | 2,5 mc/h | AFS/CSW | ML0R020G02 | 91,33 |
| R | 2,5 mc/h | DUALE/GREY | ML4R020G02 | 91,33 |
| R | 2,5 mc/h | MIX | ML2R02MG02 | 329,51 |

SENZA MISURATORI CON TRONCHETTO SPAZIATORE - WITHOUT FLOW METERS WITH CONNECTION PIPES

| LINEE RISCALDAMENTO - HEATING RANGE | | | |
|-------------------------------------|-----|------------|--------|
| Q3 | H/C | COD. SX/DX | € |
| 3/4" F x 110 mm | H/C | M82B010A02 | 239,71 |
| 1" F x 130 mm | H/C | M82B020A02 | 243,90 |

| LINEE SANITARIE - SANITARY HOT AND COLD WATER LINES | | | |
|---|------------|------------|--------|
| QP | AFS/ACS | COD. SX/DX | € |
| 3/4" F x 110 mm | ACS/HSW | ML1B020G02 | 27,87 |
| 3/4" F x 110 mm | AFS/CSW | ML0B020G02 | 27,87 |
| 3/4" F x 110 mm | MIX | ML2B02MG02 | 197,26 |
| 3/4" F x 110 mm | DUALE/GREY | ML4B020G02 | 29,58 |

CASSETTE, ZANCHE, ARMADI MULTIUTENZA - CABINETS, BRACKETS, MULTI-USERS CABINETS

| IVR 409 CASSETTA / ZANCHE - CABINETS/BRACKETS | | | |
|---|------------|------------|--------|
| D/M/R | DIMENSIONI | COD. SX/DX | € |
| D/M | 550 X 550 | MB55027D01 | 220,34 |
| R | 550 X 550 | MB55027R01 | 233,20 |
| D/M | 650 X 550 | MB65027D01 | 302,91 |
| R | 650 X 550 | MB65027R01 | 315,00 |
| ZANCA | 350 X 550 | MB01527Z01 | 80,01 |
| ZANCA | 550 X 550 | MB05527Z01 | 153,11 |
| ZANCA | 650 X 550 | MB06527Z01 | 164,58 |

| CASSETTA MULTIUTENZA - MULTI-USER CABINETS | | | |
|--|---------------------|------------|---------|
| D/M/R | DIMENSIONI | COD. SX/DX | € |
| D/M | 2 UTENZE 1080 X 550 | MB72027D01 | 543,33 |
| R | 2 UTENZE 1080 X 550 | MB72027R01 | 586,74 |
| D/M | 3 UTENZE 1630 X 550 | MB73027D01 | 835,71 |
| R | 3 UTENZE 1630 X 550 | MB73027R01 | 900,82 |
| D/M | 4 UTENZE 2180 X 550 | MB74027D01 | 1079,63 |
| R | 4 UTENZE 2180 X 550 | MB74027R01 | 1166,44 |

IVR MULTIKLIMA 472



Dimensioni - Sizes - Maßen - Fixation - Размеры:
H = 550 mm • L = 550 mm • P = 110-150 mm

Modulo IVR MULTIKLIMA 472 - con valvola 2 vie e miscelatore ACS/AFS
IVR MULTIKLIMA 472 Metering Set - with 2 ways valve and mixing valve DHW/DCW
IVR MULTIKLIMA 472 Modul mit 2 Wege Kugelhahn und Warm-/Kaltwassermischung
Module IVR MULTIKLIMA 472 avec vanne 2 voies et mitigeur ECS/EFS
IVR MULTIKLIMA 472 Узел учета - с двухходовым клапаном и смесительным клапаном ГВС/ХВС



IVR MULTIKLIMA 472 PLUS

Modulo IVR MULTIKLIMA 472 PLUS con linea per acqua di servizio
IVR MULTIKLIMA 472 PLUS Metering Set with additional grey water line
IVR MULTIKLIMA 472 PLUS Zählermodul mit zusätzlicher Nutzwasserleitung
IVR MULTIKLIMA 472 PLUS Module pour la comptabilisation avec la ligne additionnelle de l'eau de récupération
IVR MULTIKLIMA 472 Plus с линией дополнительной подачи для технической воды

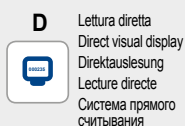

D Lettura diretta
Direct visual display
Direktauslesung
Lecture directe
Система прямого считывания

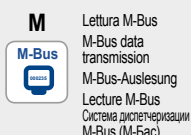

M Lettura M-Bus
M-Bus data transmission
M-Bus-Auslesung
Lecture M-Bus
Система диспечеризации M-Bus (M-Bac)



R Lettura Radio
Radio data transmission
Funkauslesung
Lecture Radio
Система Радио

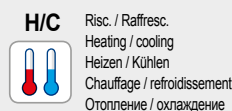

H/C Risc. / Raffresc.
Heating / cooling
Heizen / Kühlen
Chauffage / refroidissement
Отопление / охлаждение

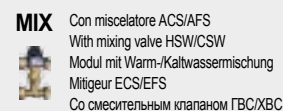

MIX Con miscelatore ACS/AFS
With mixing valve HSW/CSW
Modul mit Warm-/Kaltwassermischung
Mitigeur ECS/EFS
Со смесительным клапаном ГВС/ХВС

COMPLETE DI MISURATORI - WITH FLOW METERS

| IVR 472 LINEE RISCALDAMENTO - HEATING RANGE | | | | | |
|---|----------|-----|---------------|---------------|--------|
| D/M/R | Q3 | H/C | COD. SX. LEFT | COD. DX RIGHT | € |
| D | 1,5 mc/h | H/C | M72D014G02 | M72D114G02 | 503,85 |
| D | 2,5 mc/h | H/C | M72D024G02 | M72D124G02 | 516,45 |
| M | 1,5 mc/h | H/C | M72M014G02 | M72M114G02 | 576,50 |
| M | 2,5 mc/h | H/C | M72M024G02 | M72M124G02 | 589,10 |
| R | 1,5 mc/h | H/C | M72R014G02 | M72R114G02 | 645,32 |
| R | 2,5 mc/h | H/C | M72R024G02 | M72R124G02 | 657,92 |

| IVR 400 LINEE SANITARIE - SANITARY HOT AND COLD WATER LINES | | | | | |
|---|----------|------------|------------|--------|--|
| D/M/R | QP | AFS/ACS | CODICE | € | |
| D | 2,5 mc/h | ACS/HSW | ML1D020G02 | 68,01 | |
| D | 2,5 mc/h | AFS/CSW | ML0D020G02 | 55,39 | |
| D | 2,5 mc/h | DUALE/GREY | ML4D020G02 | 55,39 | |
| D | 2,5 mc/h | MIX | ML2D02MG02 | 261,50 | |
| M | 2,5 mc/h | ACS/HSW | ML1M020G02 | 99,94 | |
| M | 2,5 mc/h | AFS/CSW | ML0M020G02 | 91,33 | |
| M | 2,5 mc/h | DUALE/GREY | ML4M020G02 | 91,33 | |
| M | 2,5 mc/h | MIX | ML2M02MG02 | 329,37 | |
| R | 2,5 mc/h | ACS/HSW | ML1R020G02 | 99,94 | |
| R | 2,5 mc/h | AFS/CSW | ML0R020G02 | 91,33 | |
| R | 2,5 mc/h | DUALE/GREY | ML4R020G02 | 91,33 | |
| R | 2,5 mc/h | MIX | ML2R02MG02 | 329,51 | |

SENZA MISURATORI CON TRONCHETTO SPAZIATORE - WITHOUT FLOW METERS WITH CONNECTION PIPES

| LINEE RISCALDAMENTO - HEATING RANGE | | | |
|-------------------------------------|-----|------------|--------|
| Q3 | H/C | COD. SX/DX | € |
| 3/4" F x 110 mm | H/C | M72B010A02 | 165,09 |
| 1" F x 130 mm | H/C | M72B020A02 | 169,27 |

| LINEE SANITARIE - SANITARY HOT AND COLD WATER LINES | | | |
|---|------------|------------|--------|
| QP | AFS/ACS | COD. SX/DX | € |
| 3/4" F x 110 mm | ACS/HSW | ML1B020G02 | 27,87 |
| 3/4" F x 110 mm | AFS/CSW | ML0B020G02 | 27,87 |
| 3/4" F x 110 mm | MIX | ML2B02MG02 | 197,26 |
| 3/4" F x 110 mm | DUALE/GREY | ML4B020G02 | 29,58 |

CASSETTE, ZANCHE, ARMADI MULTIUTENZA - CABINETS, BRACKETS, MULTI-USERS CABINETS

| IVR 409 CASSETTA / ZANCHE - CABINETS/BRACKETS | | | |
|---|------------|------------|--------|
| D/M/R | DIMENSIONI | COD. SX/DX | € |
| D/M | 550 X 550 | MB55027D01 | 220,34 |
| R | 550 X 550 | MB55027R01 | 233,20 |
| D/M | 650 X 550 | MB65027D01 | 302,91 |
| R | 650 X 550 | MB65027R01 | 315,00 |
| ZANCA | 350 X 550 | MB01527Z01 | 80,01 |
| ZANCA | 550 X 550 | MB05527Z01 | 153,11 |
| ZANCA | 650 X 550 | MB06527Z01 | 164,58 |

| CASSETTA MULTIUTENZA - MULTI-USER CABINETS | | | |
|--|---------------------|------------|---------|
| D/M/R | DIMENSIONI | COD. SX/DX | € |
| D/M | 2 UTENZE 1080 X 550 | MB72027D01 | 543,33 |
| R | 2 UTENZE 1080 X 550 | MB72027R01 | 586,74 |
| D/M | 3 UTENZE 1630 X 550 | MB73027D01 | 835,71 |
| R | 3 UTENZE 1630 X 550 | MB73027R01 | 900,82 |
| D/M | 4 UTENZE 2180 X 550 | MB74027D01 | 1079,63 |
| R | 4 UTENZE 2180 X 550 | MB74027R01 | 1166,44 |

IVR MULTIKLIMA 481



Dimensioni - Sizes - Maßen - Fixation - Размеры:
H = 550 mm • L = 550 mm • P = 110-150 mm

Modulo IVR MULTIKLIMA 481 - con bilanciamento statico e miscelatore ACS/AFS
IVR MULTIKLIMA 481 Metering Set - with static balancing valve and mixing valve DHW/DCW
IVR MULTIKLIMA 481 Modul mit statischem Ausgleich und Warm-/Kaltwassermischung
Module IVR MULTIKLIMA 481 avec vanne d'équilibrage statique et mitigeur ECS/EFS
IVR MULTIKLIMA 481- Узел учета со статическим балансировочным клапаном и смесительным клапаном ГВС/ХВС



IVR MULTIKLIMA 481 PLUS

Modulo IVR MULTIKLIMA 481 PLUS con linea per acqua di servizio
IVR MULTIKLIMA 481 PLUS Metering Set with additional grey water line
IVR MULTIKLIMA 481 PLUS Zählermodul mit zusätzlicher Nutzwasserleitung
IVR MULTIKLIMA 481 PLUS Module pour la comptabilisation avec la ligne additionnelle de l'eau de récupération
IVR MULTIKLIMA 481 Plus с линией дополнительной подачи для технической воды



D Lettura diretta
Direct visual display
Direktauslesung
Lecture directe
Система прямого считывания



M Lettura M-Bus
M-Bus data transmission
M-Bus-Auslesung
Lecture M-Bus
Система диспетчеризации M-Bus (M-Бас)



R Lettura Radio
Radio data transmission
Funkauslesung
Lecture Radio
Система Радио



H/C Risc. / Raffresc.
Heating / cooling
Heizen / Kühlen
Chauffage / refroidissement
Отопление / охлаждение



MIX Con miscelatore ACS/AFS
With mixing valve HSW/CSW
Modul mit Warm-/Kaltwassermischung
Mitigeur ECS/EFS
Со смесительным клапаном ГВС/ХВС

COMPLETE DI MISURATORI - WITH FLOW METERS

| IVR 481 LINEE RISCALDAMENTO - HEATING RANGE | | | | | |
|---|----------|-----|---------------|----------------|--------|
| D/M/R | Q3 | H/C | COD. SX. LEFT | COD. DX. RIGHT | € |
| D | 1,5 mc/h | H/C | M81D014G02 | M81D114G02 | 483,48 |
| D | 2,5 mc/h | H/C | M81D024G02 | M81D124G02 | 496,08 |
| M | 1,5 mc/h | H/C | M81M014G02 | M81M114G02 | 556,13 |
| M | 2,5 mc/h | H/C | M81M024G02 | M81M124G02 | 568,73 |
| R | 1,5 mc/h | H/C | M81R014G02 | M81R114G02 | 624,95 |
| R | 2,5 mc/h | H/C | M81R024G02 | M81R124G02 | 637,55 |

| IVR 400 LINEE SANITARIE - SANITARY HOT AND COLD WATER LINES | | | | |
|---|----------|------------|------------|--------|
| D/M/R | QP | AFS/ACS | CODICE | € |
| D | 2,5 mc/h | ACS/HSW | ML1D020G02 | 68,01 |
| D | 2,5 mc/h | AFS/CSW | ML0D020G02 | 55,39 |
| D | 2,5 mc/h | DUALE/GREY | ML4D020G02 | 55,39 |
| D | 2,5 mc/h | MIX | ML2D02MG02 | 261,50 |
| M | 2,5 mc/h | ACS/HSW | ML1M020G02 | 99,94 |
| M | 2,5 mc/h | AFS/CSW | ML0M020G02 | 91,33 |
| M | 2,5 mc/h | DUALE/GREY | ML4M020G02 | 91,33 |
| M | 2,5 mc/h | MIX | ML2M02MG02 | 329,37 |
| R | 2,5 mc/h | ACS/HSW | ML1R020G02 | 99,94 |
| R | 2,5 mc/h | AFS/CSW | ML0R020G02 | 91,33 |
| R | 2,5 mc/h | DUALE/GREY | ML4R020G02 | 91,33 |
| R | 2,5 mc/h | MIX | ML2R02MG02 | 329,51 |

SENZA MISURATORI CON TRONCHETTO SPAZIATORE - WITHOUT FLOW METERS WITH CONNECTION PIPES

| LINEE RISCALDAMENTO - HEATING RANGE | | | |
|-------------------------------------|-----|------------|--------|
| Q3 | H/C | COD. SX/DX | € |
| 3/4" F x 110 mm | H/C | M81B010A02 | 144,72 |
| 1" F x 130 mm | H/C | M81B020A02 | 148,90 |

| LINEE SANITARIE - SANITARY HOT AND COLD WATER LINES | | | |
|---|------------|------------|--------|
| QP | AFS/ACS | COD. SX/DX | € |
| 3/4" F x 110 mm | ACS/HSW | ML1B020G02 | 27,87 |
| 3/4" F x 110 mm | AFS/CSW | ML0B020G02 | 27,87 |
| 3/4" F x 110 mm | MIX | ML2B02MG02 | 197,26 |
| 3/4" F x 110 mm | DUALE/GREY | ML4B020G02 | 29,58 |

CASSETTE, ZANCHE, ARMADI MULTIUTENZA - CABINETS, BRACKETS, MULTI-USERS CABINETS

| IVR 409 CASSETTA / ZANCHE - CABINETS/BRACKETS | | | |
|---|------------|------------|--------|
| D/M/R | DIMENSIONI | COD. SX/DX | € |
| D/M | 550 X 550 | MB55027D01 | 220,34 |
| R | 550 X 550 | MB55027R01 | 233,20 |
| D/M | 650 X 550 | MB65027D01 | 302,91 |
| R | 650 X 550 | MB65027R01 | 315,00 |
| ZANCA | 350 X 550 | MB01527Z01 | 80,01 |
| ZANCA | 550 X 550 | MB05527Z01 | 153,11 |
| ZANCA | 650 X 550 | MB06527Z01 | 164,58 |

| CASSETTA MULTIUTENZA - MULTI-USER CABINETS | | | |
|--|---------------------|------------|---------|
| D/M/R | DIMENSIONI | COD. SX/DX | € |
| D/M | 2 UTENZE 1080 X 550 | MB72027D01 | 543,33 |
| R | 2 UTENZE 1080 X 550 | MB72027R01 | 586,74 |
| D/M | 3 UTENZE 1630 X 550 | MB73027D01 | 835,71 |
| R | 3 UTENZE 1630 X 550 | MB73027R01 | 900,82 |
| D/M | 4 UTENZE 2180 X 550 | MB74027D01 | 1079,63 |
| R | 4 UTENZE 2180 X 550 | MB74027R01 | 1166,44 |

IVR MULTIKLIMA 471



Dimensioni - Sizes - Maßen - Fixation - Размеры:
H = 550 mm • L = 550 mm • P = 110-150 mm

Modulo IVR MULTIKLIMA 471 - con miscelatore ACS/AFS
IVR MULTIKLIMA 471 Metering Set - with mixing valve DHW/DCW
IVR MULTIKLIMA 471 Modul mit Warm-/Kaltwassermischung
Module IVR MULTIKLIMA 471 Mitigeur ECS/EFS
IVR MULTIKLIMA 471 Узел учета со смесительным клапаном ГВС/ХВС



IVR MULTIKLIMA 471 PLUS

Modulo IVR MULTIKLIMA 471 PLUS con linea per acqua di servizio
IVR MULTIKLIMA 471 PLUS Metering Set with additional grey water line
IVR MULTIKLIMA 471 PLUS Zählermodul mit zusätzlicher Nutzwasserleitung
IVR MULTIKLIMA 471 PLUS Module pour la comptabilisation avec la ligne additionnelle de l'eau de récupération
IVR MULTIKLIMA 471 Plus с линией дополнительной подачи для технической воды

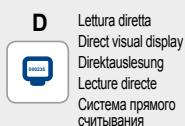

D Lettura diretta
Direct visual display
Direktauslesung
Lecture directe
Система прямого считывания

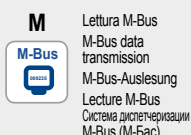

M Lettura M-Bus
M-Bus data transmission
M-Bus-Auslesung
Lecture M-Bus
Система диспечеризации M-Bus (M-Бас)



R Lettura Radio
Radio data transmission
Funkauslesung
Lecture Radio
Система Радио

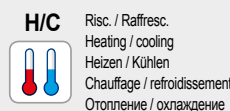

H/C Risc. / Raffresc.
Heating / cooling
Heizen / Kühlen
Chauffage / refroidissement
Отопление / охлаждение

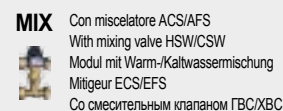

MIX Con miscelatore ACS/AFS
With mixing valve HSW/CSW
Modul mit Warm-/Kaltwassermischung
Mitigeur ECS/EFS
Со смесительным клапаном ГВС/ХВС

COMPLETE DI MISURATORI - WITH FLOW METERS

| IVR 471 LINEE RISCALDAMENTO - HEATING RANGE | | | | | |
|---|----------|-----|---------------|---------------|--------|
| D/M/R | Q3 | H/C | COD. SX. LEFT | COD. DX RIGHT | € |
| D | 1,5 mc/h | H/C | M71D014G02 | M71D114G02 | 403,83 |
| D | 2,5 mc/h | H/C | M71D024G02 | M71D124G02 | 416,43 |
| M | 1,5 mc/h | H/C | M71M014G02 | M71M114G02 | 476,48 |
| M | 2,5 mc/h | H/C | M71M024G02 | M71M124G02 | 489,08 |
| R | 1,5 mc/h | H/C | M71R014G02 | M71R114G02 | 545,30 |
| R | 2,5 mc/h | H/C | M71R024G02 | M71R124G02 | 557,90 |

| IVR 400 LINEE SANITARIE - SANITARY HOT AND COLD WATER LINES | | | | | |
|---|----------|------------|------------|--------|--|
| D/M/R | QP | AFS/ACS | CODICE | € | |
| D | 2,5 mc/h | ACS/HSW | ML1D020G02 | 68,01 | |
| D | 2,5 mc/h | AFS/CSW | ML0D020G02 | 55,39 | |
| D | 2,5 mc/h | DUALE/GREY | ML4D020G02 | 55,39 | |
| D | 2,5 mc/h | MIX | ML2D02MG02 | 261,50 | |
| M | 2,5 mc/h | ACS/HSW | ML1M020G02 | 99,94 | |
| M | 2,5 mc/h | AFS/CSW | ML0M020G02 | 91,33 | |
| M | 2,5 mc/h | DUALE/GREY | ML4M020G02 | 91,33 | |
| M | 2,5 mc/h | MIX | ML2M02MG02 | 329,37 | |
| R | 2,5 mc/h | ACS/HSW | ML1R020G02 | 99,94 | |
| R | 2,5 mc/h | AFS/CSW | ML0R020G02 | 91,33 | |
| R | 2,5 mc/h | DUALE/GREY | ML4R020G02 | 91,33 | |
| R | 2,5 mc/h | MIX | ML2R02MG02 | 329,51 | |

SENZA MISURATORI CON TRONCHETTO SPAZIATORE - WITHOUT FLOW METERS WITH CONNECTION PIPES

| LINEE RISCALDAMENTO - HEATING RANGE | | | |
|-------------------------------------|-----|------------|-------|
| Q3 | H/C | COD. SX/DX | € |
| 3/4" F x 110 mm | H/C | M71B010A02 | 65,07 |
| 1" F x 130 mm | H/C | M71B020A02 | 69,25 |

| LINEE SANITARIE - SANITARY HOT AND COLD WATER LINES | | | |
|---|------------|------------|--------|
| QP | AFS/ACS | COD. SX/DX | € |
| 3/4" F x 110 mm | ACS/HSW | ML1B020G02 | 27,87 |
| 3/4" F x 110 mm | AFS/CSW | ML0B020G02 | 27,87 |
| 3/4" F x 110 mm | MIX | ML2B02MG02 | 197,26 |
| 3/4" F x 110 mm | DUALE/GREY | ML4B020G02 | 29,58 |

CASSETTE, ZANCHE, ARMADI MULTIUTENZA - CABINETS, BRACKETS, MULTI-USERS CABINETS

| IVR 409 CASSETTA / ZANCHE - CABINETS/BRACKETS | | | |
|---|------------|------------|--------|
| D/M/R | DIMENSIONI | COD. SX/DX | € |
| D/M | 550 X 550 | MB55027D01 | 220,34 |
| R | 550 X 550 | MB55027R01 | 233,20 |
| D/M | 650 X 550 | MB65027D01 | 302,91 |
| R | 650 X 550 | MB65027R01 | 315,00 |
| ZANCA | 350 X 550 | MB01527Z01 | 80,01 |
| ZANCA | 550 X 550 | MB05527Z01 | 153,11 |
| ZANCA | 650 X 550 | MB06527Z01 | 164,58 |

| CASSETTA MULTIUTENZA - MULTI-USER CABINETS | | | |
|--|---------------------|------------|---------|
| D/M/R | DIMENSIONI | COD. SX/DX | € |
| D/M | 2 UTENZE 1080 X 550 | MB72027D01 | 543,33 |
| R | 2 UTENZE 1080 X 550 | MB72027R01 | 586,74 |
| D/M | 3 UTENZE 1630 X 550 | MB73027D01 | 835,71 |
| R | 3 UTENZE 1630 X 550 | MB73027R01 | 900,82 |
| D/M | 4 UTENZE 2180 X 550 | MB74027D01 | 1079,63 |
| R | 4 UTENZE 2180 X 550 | MB74027R01 | 1166,44 |

ACCESSORI MULTIKLIMA / MULTIKLIMA ACCESSORIES

IVR 4A0



Set 2 tubi di collegamento linee riscaldamento
 Set of 2 union pipes for heating lines
 Garnitur von 2 Anschlussrohren für die Heizungsleitungen
 Set de 2 tubes de connexion pour les lignes de chauffage
 Набор из 2-х соединительных труб для сегмента отопления

| Cod./Code | □/田 | € |
|------------|-----|-------|
| 4A00000A10 | 1 | 26,61 |

IVR 4A0



Set 2 tubi di collegamento linee acqua sanitaria
 Set of 2 union pipes for sanitary water lines
 Garnitur von 2 Anschlussrohren für die Wasserleitungen
 Set de 2 tubes de connexion pour les lignes de l'eau sanitaire
 Набор из 2-х соединительных труб для сегмента санитарного водоснабжения

| Cod./Code | □/田 | € |
|------------|-----|-------|
| 4A00000A12 | 1 | 25,81 |

IVR 4A0



Set 3 tubi di collegamento linee acqua sanitaria e acqua duale di servizio
 Set of 3 union pipes for sanitary water and greywater lines
 Garnitur von 3 Anschlussrohren für Wasser- und Nutwasserleitungen
 Set de 3 tubes de connexion pour les lignes de l'eau sanitaire et de l'eau de récupération
 Набор из 3-х соединительных труб для сегментов санитарного и технического водоснабжения

| Cod./Code | □/田 | € |
|------------|-----|-------|
| 4A00000A13 | 1 | 38,56 |

IVR 4A0



Set 4 di tubi collegamento linee riscaldamento e acqua sanitaria
 Set of 4 union pipes for heating and sanitary water lines
 Garnitur von 4 Anschlussrohren für Heizungs- und Wasserleitungen
 Set de 4 tubes pour les lignes de chauffage et de l'eau sanitaire
 Набор из 4-х соединительных труб для сегмента отопления и санитарного водоснабжения

| Cod./Code | □/田 | € |
|------------|-----|-------|
| 4A00000A14 | 1 | 52,48 |

IVR 4A0

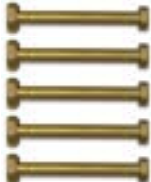

Set 5 di tubi collegamento linee riscaldamento, acqua sanitaria e acqua duale di servizio
 Set of 5 union pipes for heating, sanitary water and greywater lines
 Garnitur von 4 Anschlussrohren für Heizungs- und Wasserleitungen
 Set de 5 tubes pour les lignes de chauffage, de l'eau sanitaire et de l'eau de récupération
 Набор из 5 соединительных труб для сегментов санитарного и технического водоснабжения

| Cod./Code | □/田 | € |
|------------|-----|-------|
| 4A00000A15 | 1 | 65,10 |

IVR 847 M



Guscio di coibentazione per linee di riscaldamento/raffrescamento
 Insulating shell for heating/cooling lines
 Isolierhülse für Heizung/Erkältungsleitungen
 Coque isolante pour les lignes de chauffage/rafraîchissement
 Изолирующая оболочка для систем нагрева / охлаждения

| Cod./Code | □/田 | € |
|-----------|------|-------|
| 335800412 | SX 1 | 43,17 |
| 335800413 | DX 1 | 43,17 |

IVR 496



Centralina Datalogger M-Bus
 M-Bus Data logger
 M-Bus Datenlogger
 Data logger M-Bus
 Регистратор данных M-Bus

| Cod./Code | □/田 | € |
|-----------|-------|---------|
| 149600060 | 60 1 | 916,88 |
| 149600120 | 120 1 | 1556,25 |
| 149600250 | 250 1 | 1687,50 |

IVR 335



Convertitore di segnale M-Bus fissaggio a muro
 M-Bus signal converter - wall mounting
 M-Bus Signalumsetzer - Wandbefestigung
 Convertisseur de signal - fixé au mur
 Конвертирующий адаптер сигнала M-Bus - настенный монтаж

| Cod./Code | □/田 | € |
|-----------|-----|--------|
| 335800107 | 1 | 137,65 |

IVR 497



MODEM GSM trasmissione dati con antenna
 GSM MODEM for antenna data transmission
 GSM MODEM für Übertragungen mittels Antenne
 MODEM GSM pour les transmissions avec antenne
 МОДЕМ GSM - прибор передачи данных с антенной

| Cod./Code | □/田 | € |
|-----------|-----|--------|
| 1497PY001 | 1 | 621,56 |



VALVOLE PER RADIATORI / RADIATOR VALVES

Valvole termostatiche / Thermostatic valves
THERMOCHROME

KIT TERMOARREDO composto da valvola termostattizzabile e detentore, cromati
KIT for design radiator with thermostatic valve and lockshield, chrome-plated
DESIGNGARNITUR: Regulierventil (für Thermostat) und Rücklaufverschraubung, verchromt
KIT pour radiateurs design composé de vanne thermostatizable et coude de réglage chromés
Комплект для дизайнерских радиаторов, состоящий из термостатического и отсекающего клапанов, хромированный

IVR 597 CHR



Testa termostatica con sensore a liquido; a bassa inerzia termica - Cromata, dark grey e light grey
Thermostatic head with liquid sensor; low thermal inertia - Chrome-plated, dark grey and light grey
Thermostatkopf mit Flüssigkeitssensor; geringe thermische Trägheit - Verchromt, dark grey und light grey
Tête thermostatique avec capteur à liquide - à faible inertie thermique - Chromée, dark grey et light grey
Термостатическая головка с жидкостным сенсором с низкой термоинерцией - Хромированная.
Цвет: светло-серый и тёмно-серый

| Cod./Code | Misura/Size | □/田 | € |
|-----------|-------------|----------------|-------|
| 159700701 | chrome | M30 x 1,5 1/50 | 20,00 |
| 159700704 | dark grey | M30 x 1,5 1/50 | 20,00 |
| 159700705 | light grey | M30 x 1,5 1/50 | 20,00 |

IVR 777 CHR



A squadra, attacco tubo rame, PEX e multistrato
Angle, PEX, multilayer and copper pipe connection
Eckförmig, Anschluss für Kupfer, PEX und Mehrschichtrohr
Équerre, fixation tube en cuivre, PEX et multicouche
Угловой, соединение для медной, PEX и многослойной трубы

| Cod./Code | Misura/Size | Attacco/Connection | □/田 | € |
|-----------|-------------|--------------------|------|-------|
| 177705185 | 1/2" | 24-19 | 1/15 | 36,16 |

IVR 563 CHR

NEW



THERMOCHROME, valvola termostattizzabile a squadra, attacco PEX, multistrato e tubo rame, bocchettone autotenuta, cromata

THERMOCHROME, chrome-plated angle thermostatic valve, PEX, multilayer and copper pipe connection, auto seal tail piece

THERMOCHROME, Eckthermostatventil, Anschluss für PEX, Kupfer- und Mehrschichtrohr, mit Selbstdichtung, verchromt

THERMOCHROME, vanne thermostatizable équerre, fixation PEX, multicouche et tube en cuivre, raccord avec auto-étanche, chromée

THERMOCHROME, термостатический угловой клапан, соединение для PEX, металлопластиковой и стальной трубы. С самогерметизирующимся патрубком. хромированный.

| Cod./Code | Misura/Size | Attacco/Connection | □/田 | € |
|-----------|-------------|--------------------|------|-------|
| 156305187 | 1/2" | 24-19 | 1/18 | 20,04 |

IVR 557 CHR

NEW



THERMOCHROME, detentore a squadra, attacco PEX, multistrato e tubo rame, bocchettone autotenuta, cromato

THERMOCHROME, chrome-plated angle lockshield, PEX, multilayer and copper pipe connection, autoseal tail piece

THERMOCHROME, Eckrücklaufverschraubung, Anschluss für PEX, für Kupfer- und Mehrschichtrohr, mit Selbstdichtung, verchromt

THERMOCHROME, coude de réglage équerre, fixation PEX, multicouche et tube en cuivre, chromé

THERMOCHROME, угловой стопорный клапан, соединение для PEX, металлопластиковой и стальной трубы. С самогерметизирующимся патрубком. хромированный.

| Cod./Code | Misura/Size | Attacco/Connection | □/田 | € |
|-----------|-------------|--------------------|------|-------|
| 155705187 | 1/2" | 24-19 | 1/18 | 15,58 |

IVR 776 CHR



Dritto, attacco tubo rame, PEX e multistrato

Straight, PEX, multilayer and copper pipe connection

gerade, Anschluss für Kupfer, PEX und Mehrschichtrohr

Droit, fixation tube en cuivre, PEX et multicouche

Прямой, соединение для медной, PEX и многослойной трубы

| Cod./Code | Misura/Size | Attacco/Connection | □/田 | € |
|-----------|-------------|--------------------|------|-------|
| 177605185 | 1/2" | 24-19 | 1/15 | 37,86 |

IVR 562 CHR

NEW



THERMOCHROME, valvola termostattabile diritta, attacco PEX, multistrato e tubo rame, bocchettone autotenuta, cromata

THERMOCHROME, chrome-plated straight thermostatic valve, PEX, multilayer and copper pipe connection, autoseal tail piece

THERMOCHROME, Gerade Thermostatventil, Anschluss für PEX, Kupfer- und Mehrschichtrohr, mit Selbstdichtung, verchromt

THERMOCHROME, vanne thermostatizable droite, fixation PEX, multicouche et tube en cuivre, raccord avec auto-étanche, chromée

THERMOCHROME, термостатический прямой клапан, соединение для PEX, металлопластиковой и стальной трубы. С самогерметизирующимся патрубком. хромированный.

| Cod./Code | Misura/Size | Attacco/Connection | □/田 | € |
|-----------|-------------|--------------------|------|-------|
| 156205187 | 1/2" | 24-19 | 1/18 | 20,80 |

IVR 555 CHR

NEW



THERMOCHROME, detentore diritto, attacco PEX, multistrato e tubo rame, bocchettone autotenuta, cromato

THERMOCHROME, chrome-plated straight lockshield, PEX, multilayer and copper pipe connection, autoseal tail piece

THERMOCHROME, Gerade Rücklaufverschraubung, Anschluss für PEX, für Kupfer- und Mehrschichtrohr, mit Selbstdichtung, verchromt

THERMOCHROME, coude de réglage droit, fixation PEX, multicouche et tube en cuivre, chromé

THERMOCHROME, прямой стопорный клапан, соединение для PEX, металлопластиковой и стальной трубы. С самогерметизирующимся патрубком. хромированный.

| Cod./Code | Misura/Size | Attacco/Connection | □/田 | € |
|-----------|-------------|--------------------|------|-------|
| 155505187 | 1/2" | 24-19 | 1/18 | 16,52 |



IVR 774 CHR



A squadra, fornita con adattatore per attacco tubo ferro
Angle, iron pipe connection
Eckförmig, Anschluss für Eisenrohr
Équerre, fixation tube en cuivre
Угловой вентиль, соединение для стальной трубы

| Cod./Code | Misura/Size | □/⊞ | € |
|-----------|-------------|------|-------|
| 177405005 | 1/2" | 1/15 | 51,02 |

IVR 561 CHR



THERMOCHROME, valvola termostattabile a squadra, fornita con adattatore per attacco tubo ferro, bocchettone autotenuta, cromata
THERMOCHROME, chrome-plated angle thermostatic valve, iron pipe connection, autoseal tail piece
THERMOCHROME, eckförmiges Thermostatventil, Anschluss für Eisenrohr, mit Selbstdichtung, verchromt
THERMOCHROME, vanne thermostatisable équerre, fournie avec adaptateurs pour fixation tube en fer, raccord avec auto-étanche, chromée
THERMOCHROME, термостатический угловой клапан, поставляется с адаптером для стальной трубы, с самогерметизирующимся патрубком. хромированный.

| Cod./Code | Misura/Size | □/⊞ | € |
|-----------|-------------|------|-------|
| 156105015 | 1/2" | 1/18 | 27,21 |

IVR 553 CHR



THERMOCHROME, detentore a squadra, fornita con adattatore per attacco tubo ferro, bocchettone autotenuta, cromato
THERMOCHROME, chrome-plated angle lockshield, iron pipe connection, autoseal tail piece
THERMOCHROME, Eckrücklaufverschraubung mit Anschluss für Eisenrohr, mit Selbstdichtung, verchromt
THERMOCHROME, coude de réglage équerre, fixation tube en fer, raccord avec auto-étanche, chromé
THERMOCHROME, угловой стопорный клапан, поставляется с адаптером для стальной трубы, с самогерметизирующимся патрубком. хромированный.

| Cod./Code | Misura/Size | □/⊞ | € |
|-----------|-------------|------|-------|
| 155305015 | 1/2" | 1/18 | 22,77 |

IVR 773 CHR



Dritto, fornita con adattatore per attacco tubo ferro
Straight, iron pipe connection
Gerade Verschraubung, Anschluss für Eisenrohr
Droit, fixation tube fer
Прямой вентиль, соединение для стальной трубы

| Cod./Code | Misura/Size | □/⊞ | € |
|-----------|-------------|------|-------|
| 177305005 | 1/2" | 1/15 | 52,76 |

IVR 560 CHR



THERMOCHROME, valvola termostaticabile diritta, fornita con adattatore per attacco tubo ferro, bocchettone autotenuta, cromata

THERMOCHROME, chrome-plated straight thermostatic valve, iron pipe connection, autoseal tail piece

THERMOCHROME, Gerade Rücklaufverschraubung mit Anschluss für Eisenrohr, mit Selbstdichtung, verchromt

THERMOCHROME, vanne thermostatizable droite, fournie avec adaptateurs pour fixation tube en fer, raccord avec auto-étanche, chromée

THERMOCHROME, термостатический прямой клапан, поставляется с адаптером для стальной трубы, с самогерметизирующимся патрубком хромированный.

| Cod./Code | Misura/Size | □/田 | € |
|-----------|-------------|------|-------|
| 156005015 | 1/2" | 1/18 | 27,96 |

IVR 551 CHR



THERMOCHROME, detentore diritto, fornita con adattatore per attacco tubo ferro, bocchettone autotenuta, cromato

THERMOCHROME, chrome-plated straight lockshield, iron pipe connection, autoseal tail piece

THERMOCHROME, Gerade Rücklaufverschraubung mit Anschluss für Eisenrohr, mit Selbstdichtung, verchromt

THERMOCHROME, coude de réglage droit, fourni avec adaptateurs pour fixation tube en fer, raccord avec auto-étanche, chromé

THERMOCHROME, прямой стопорный клапан, поставляется с адаптером для стальной трубы, с самогерметизирующимся патрубком хромированный.

| Cod./Code | Misura/Size | □/田 | € |
|-----------|-------------|------|-------|
| 155105015 | 1/2" | 1/18 | 23,69 |

IVR 580 CHR



Adattatori per tubo rame - Cromati

Adapters for copper pipe - Chrome

Zwischenstücke / Adapter für Kupferrohr - verchromt

Adaptateurs pour tubes en cuivre - Chromé

Фитинги для медной трубы - хромированные

| Cod./Code | Misura/Size | Attacco/Connection | CH(mm) | □/田 | € |
|-----------|-------------|--------------------|--------|--------|------|
| 158024710 | 10 | 24-19 | 27 | 10/180 | 6,33 |
| 158024720 | 12 | 24-19 | 27 | 10/180 | 7,04 |
| 158024740 | 14 | 24-19 | 27 | 10/180 | 5,66 |
| 158024750 | 15 | 24-19 | 27 | 10/180 | 5,92 |
| 158024760 | 16 | 24-19 | 27 | 10/180 | 5,19 |

IVR 581 CHR



Adattatori universali a compressione per tubi multistrato e polietilene reticolato PEX, nichelati - Cromati

Adapters for multilayer pipe and cross-linked polyethylene pipe PEX, nickel plated - chrome-plated

Universal-Zwischenstücke/Adapter zur Kompression für Mehrschichtrohren und Rohren aus vernetztem Polyethylen PEX - vernickelt - verchromt

Adaptateurs universels à compression pour tubes multicouche et polyéthylène réticulé PEX - nickelés - Chromé

Фитинги для многослойной трубы и труб из сшитого полиэтилена PEX, никелированные - хромированные

| Cod./Code | Misura/Size | Attacco/Connection | CH(mm) | □/田 | € |
|-----------|-------------|--------------------|--------|--------|------|
| 158124743 | 14 x 2 | 24-19 | 27 | 10/200 | 6,88 |
| 158124763 | 16 x 2 | 24-19 | 27 | 10/200 | 5,96 |
| 158124764 | 16 x 2,2 | 24-19 | 27 | 10/200 | 5,62 |



VALVOLE PER RADIATORI / RADIATOR VALVES

Valvole termostatiche / Thermostatic valves

Testa termostatica con sensore a liquido; a bassa inerzia termica
Thermostatic head with liquid sensor; low thermal inertia
Thermostatkopf mit Flüssigkeitssensor; geringe thermische Trägheit
Tête thermostatique avec capteur à liquide - à faible inertie thermique
Термостатическая головка с жидкостным сенсором; с низкой термоинерцией

IVR 597



Testa termostatica con sensore a liquido; a bassa inerzia termica - Bianca, dark grey e light grey
Thermostatic head with liquid sensor; low thermal inertia - White, dark grey and light grey
Thermostatkopf mit Flüssigkeitssensor; geringe thermische Trägheit - Verchromt
Weiß, dark grey und light grey
Tête thermostatique avec capteur à liquide - à faible inertie thermique - Blanc, dark grey et light grey
Термостатическая головка с жидкостным сенсором; с низкой термоинерцией - Белая
Цвет: светло-серый и тёмно-серый

| Cod./Code | | Misura/Size | □/田 | € |
|-----------|------------|-------------|------|-------|
| 159700001 | bianca | M30 x 1,5 | 1/50 | 20,00 |
| 159700704 | dark grey | M30 x 1,5 | 1/50 | 20,00 |
| 159700705 | light grey | M30 x 1,5 | 1/50 | 20,00 |

IVR 599



Testa termostatica con sensore a liquido; a bassa inerzia termica - Con sensore a distanza
Thermostatic head with liquid sensor; low thermal inertia - With remote sensor
Thermostatkopf mit Flüssigkeitssensor; geringe thermische Trägheit. Mit Fernsensor
Tête thermostatique avec capteur à liquide - à faible inertie thermique - Avec capteur à distance
Термостатическая головка с жидкостным сенсором; с низкой термоинерцией - С дистанционным датчиком

| Cod./Code | Misura/Size | □/田 | € |
|-----------|-------------|------|-------|
| 159900001 | M30 x 1,5 | 1/15 | 19,36 |

IVR 591



Testa termostatica con sensore a liquido a bassa inerzia termica - con sonda ad immersione
Thermostatic head with liquid sensor at low thermal inertia - with sensor immersion sleeve
Thermostatkopf mit Flüssigkeitssensor mit geringer thermischen Trägheit - mit Tauchsonde
Tête thermostatique avec capteur à liquide à faible inertie thermique - avec sonde à immersion
Термостатическая головка с жидкостным сенсором, низкой термоинерцией и погружным датчиком

| Cod./Code | Misura/Size | □/田 | € |
|-----------|-------------|------|-------|
| 159100001 | M30 x 1,5 | 1/20 | 21,14 |

VALVOLE PER RADIATORI / RADIATOR VALVES

Valvole termostatiche / Thermostatic valves

SATURN - Attacco tubo ferro / Iron pipe connection

Valvola termostattabile attacco tubo ferro, bocchettone con / senza autotenuta, nichelata

Straight thermostatic valve with manual handle, iron pipe connection, with / without auto-seal tail piece; nickel plated

Thermostatventil mit Anschluss für Eisenrohr, mit /ohne Selbstdichtung - vernickelt

Vanne thermostatizable, fixation tube fer, raccord autoétanche ou non étanche - nickelée

Термостатический клапан с ручным управлением, соединение для стальной трубы, с / без самогерметизации; никелированный

IVR 561 - IVR 561/2



IVR 561



IVR 561/2

A squadra con volantino manuale

Angle valve with manual handle

Eckförmig mit Handrad

Équerre avec volant manuel

Угловой клапан с ручным управлением

| Cod./Code | Misura/Size | □/田 | € |
|-----------|-------------|-------|-------|
| 156103000 | 3/8" | 10/60 | 8,37 |
| 156105000 | 1/2" | 10/40 | 9,37 |
| 156107000 | 3/4" | 10/40 | 12,60 |

(1) 561/2 - Art. con bocchettone senza autotenuta

(1) 561/2 - Item with tail piece without auto-seal

(1) 561/2 - Art. Ventil mit Stutzen ohne Selbstdichtung

(1) 561/2 - Art. avec raccord non étanche

(1) 561/2 - Клапан с патрубком без самогерметизации

156103002 3/8" 10/60 8,08 (1)

156105002 1/2" 10/40 9,01 (1)

156107002 3/4" 10/40 11,66 (1)

IVR 561/3 - IVR 561/4 PREREGOLAZIONE / PRESETTING



IVR 561/3



IVR 561/4

Con prerogolazione, a squadra con volantino manuale

Angle valve with presetting and with manual handle

Eckförmige Verschraubung mit Voreinstellung und Handrad

Avec pré réglage, équerre avec volant manuel

Угловой термостатический клапан для радиаторов с преднастройкой и ручным управлением

| Cod./Code | Misura/Size | □/田 | € |
|-----------|-------------|-------|-----------|
| 156103003 | 3/8" | 10/60 | 8,79 |
| 156105003 | 1/2" | 10/40 | 9,80 |
| 156107003 | 3/4" | 10/40 | 13,08 |
| 156103004 | 3/8" | 10/60 | 8,53 (1) |
| 156105004 | 1/2" | 10/40 | 9,44 (1) |
| 156107004 | 3/4" | 10/40 | 12,15 (1) |

(1) 561/4 - Art. con bocchettone senza autotenuta

(1) 561/4 - Item with tail piece without auto-seal

(1) 561/4 - Art. Ventil mit Stutzen ohne Selbstdichtung

(1) 561/4 - Art. avec raccord non étanche

(1) 561/4 - Клапан с патрубком без самогерметизации



IVR 567 - IVR 567/2



IVR 567

IVR 567/2

A squadra con cappello di regolazione
Angle valve with operating plastic cap
Eckförmige Verschraubung mit Einstellkappe
A équerre, avec chapeau de réglage
Угловой термостатический клапан с регулирующим колпачком

| Cod./Code | Misura/Size | □/田 | € |
|-----------|-------------|--------|-------|
| 156703000 | 3/8" | 10/120 | 7,40 |
| 156705000 | 1/2" | 10/120 | 8,38 |
| 156707000 | 3/4" | 10/60 | 11,63 |

- (1) 567/2 - Art. con bocchettone senza autotenuta
- (1) 567/2 - Item with tail piece without auto-seal
- (1) 567/2 - Art. Ventil mit Stutzen ohne Selbstdichtung
- (1) 567/2 - Art. avec raccord non étanche
- (1) 567/2 - Клапан с патрубком без самогерметизации

| | | | | |
|-----------|------|--------|-------|-----|
| 156703002 | 3/8" | 10/120 | 7,15 | (1) |
| 156705002 | 1/2" | 10/120 | 8,02 | (1) |
| 156707002 | 3/4" | 10/60 | 10,69 | (1) |

IVR 567/3 - IVR 567/4 PREREGOLAZIONE / PRESETTING



IVR 567/3

IVR 567/4

Con prerregolazione, a squadra con cappello di regolazione
Angle valve with presetting, operating plastic cap
Eckförmige Verschraubung mit Voreinstellung und Einstellkappe
Avec préréglage, équerre avec chapeau de réglage
Угловой термостатический клапан с преднастройкой, регулирующий колпачок

| Cod./Code | Misura/Size | □/田 | € |
|-----------|-------------|--------|-------|
| 156703003 | 3/8" | 10/120 | 7,82 |
| 156705003 | 1/2" | 10/120 | 8,81 |
| 156707003 | 3/4" | 10/60 | 12,11 |

- (1) 567/4 - Art. con bocchettone senza autotenuta
- (1) 567/4 - Item with tail piece without auto-seal
- (1) 567/4 - Art. Ventil mit Stutzen ohne Selbstdichtung
- (1) 567/4 - Art. avec raccord non étanche
- (1) 567/4 - Клапан с патрубком без самогерметизации

| | | | | |
|-----------|------|--------|-------|-----|
| 156703004 | 3/8" | 10/120 | 7,57 | (1) |
| 156705004 | 1/2" | 10/120 | 8,45 | (1) |
| 156707004 | 3/4" | 10/60 | 11,17 | (1) |

IVR 570 - IVR 570/2



IVR 570

IVR 570/2

Reversa con cappello di regolazione
 Reverse angle valve with operating plastic cap
 Echförmiges Umsteuerungsventil mit Einstellkappe
 À corps inversé avec chapeau de réglage
 Реверсивный угловой термостатический клапан с регулирующим колпачком

- (1) 570/2 - Art. con bocchettone senza autotenuta
- (1) 570/2 - Item with tail piece without auto-seal
- (1) 570/2 - Art. Ventil mit Stutzen ohne Selbstdichtung
- (1) 570/2 - Art. avec raccord non étanche
- (1) 570/2 - Клапан с патрубком без самогерметизации

| Cod./Code | Misura/Size | □/田 | € |
|-----------|-------------|-------|----------|
| 157005000 | 1/2" | 10/60 | 10,17 |
| 157005002 | 1/2" | 10/60 | 9,81 (1) |

IVR 570/3 - IVR 570/4 PREREGOLAZIONE / PRESETTING



IVR 570/3

IVR 570/4

Reversa con prerregolazione, con cappello di regolazione
 Reverse angle valve with presetting and operating plastic cap
 Umsteuerungsventil mit Voreinstellung, mit Einstellkappe
 À corps inversé avec préreglage, avec chapeau de réglage
 Реверсивный термостатический клапан с регулирующим колпачком.

- (1) 570/4 - Art. con bocchettone senza autotenuta
- (1) 570/4 - Item with tail piece without auto-seal
- (1) 570/4 - Art. Ventil mit Stutzen ohne Selbstdichtung
- (1) 570/4 - Art. avec raccord non étanche
- (1) 570/4 - Клапан с патрубком без самогерметизации

| Cod./Code | Misura/Size | □/田 | € |
|-----------|-------------|-------|-----------|
| 157005003 | 1/2" | 10/60 | 10,46 |
| 157005004 | 1/2" | 10/60 | 10,10 (1) |

IVR 560 - IVR 560/2



IVR 560

IVR 560/2

Dritta con volantino manuale
 Straight with manual handle
 Gerade mit Handrad
 Droit avec volant manuel
 Прямой термостатический клапан с ручным управлением

- (1) 560/2 - Art. con bocchettone senza autotenuta
- (1) 560/2 - Item with tail piece without auto-seal
- (1) 560/2 - Art. Ventil mit Stutzen ohne Selbstdichtung
- (1) 560/2 - Art. avec raccord non étanche
- (1) 560/2 - Клапан с патрубком без самогерметизации

| Cod./Code | Misura/Size | □/田 | € |
|-----------|-------------|-------|-----------|
| 156003000 | 3/8" | 10/60 | 8,87 |
| 156005000 | 1/2" | 10/40 | 10,26 |
| 156007000 | 3/4" | 10/40 | 13,69 |
| 156003002 | 3/8" | 10/60 | 8,61 (1) |
| 156005002 | 1/2" | 10/40 | 9,90 (1) |
| 156007002 | 3/4" | 10/40 | 12,75 (1) |



IVR 560/3 - IVR 560/4 PREREGOLAZIONE / PRESETTING



IVR 560/3

IVR 560/4

Con prerogolazione, dritta con volantino manuale
Straight valve with presetting and with manual handle
Gerade Verschraubung mit Voreinstellung und Handrad
Avec préréglage, equerre avec volant manuel
Прямой термостатический клапан с преднастройкой и ручным управлением

- (1) 560/4 - Art. con bocchettone senza autotenuta
- (1) 560/4 - Item with tail piece without auto-seal
- (1) 560/4 - Art. Ventil mit Stutzen ohne Selbstdichtung
- (1) 560/4 - Art. avec raccord non étanche
- (1) 560/4 - Клапан с патрубком без самогерметизации

| Cod./Code | Misura/Size | □/田 | € |
|-----------|-------------|-------|-----------|
| 156003003 | 3/8" | 10/60 | 9,30 |
| 156005003 | 1/2" | 10/40 | 10,69 |
| 156007003 | 3/4" | 10/40 | 14,16 |
| 156003004 | 3/8" | 10/60 | 9,03 (1) |
| 156005004 | 1/2" | 10/40 | 10,33 (1) |
| 156007004 | 3/4" | 10/40 | 13,23 (1) |

IVR 566 - IVR 566/2



IVR 566

IVR 566/2

Dritta con cappello di regolazione
Straight valve with operating plastic cap
Gerade Verschraubung mit Einstellkappe
Droite avec chapeau de réglage
Прямой термостатический клапан с регулирующим колпачком

- (1) 566/2 - Art. con bocchettone senza autotenuta
- (1) 566/2 - Item with tail piece without auto-seal
- (1) 566/2 - Art. Ventil mit Stutzen ohne Selbstdichtung
- (1) 566/2 - Art. avec raccord non étanche
- (1) 566/2 - Клапан с патрубком без самогерметизации

| Cod./Code | Misura/Size | □/田 | € |
|-----------|-------------|-------|-----------|
| 156603000 | 3/8" | 10/60 | 7,92 |
| 156605000 | 1/2" | 10/60 | 9,27 |
| 156607000 | 3/4" | 10/60 | 12,70 |
| 156603002 | 3/8" | 10/60 | 7,66 (1) |
| 156605002 | 1/2" | 10/60 | 8,91 (1) |
| 156607002 | 3/4" | 10/60 | 11,77 (1) |

IVR 566/3 - IVR 566/4 PREREGOLAZIONE / PRESETTING



IVR 566/3

IVR 566/4

Con prerogolazione, dritta con cappello di regolazione
Straight valve with presetting, operating plastic cap
Gerade Verschraubung mit Voreinstellung und Einstellkappe
Avec préréglage, droite avec chapeau de réglage
Прямой термостатический клапан с преднастройкой и регулирующим колпачком

- (1) 566/4 - Art. con bocchettone senza autotenuta
- (1) 566/4 - Item with tail piece without auto-seal
- (1) 566/4 - Art. Ventil mit Stutzen ohne Selbstdichtung
- (1) 566/4 - Art. avec raccord non étanche
- (1) 566/4 - Клапан с патрубком без самогерметизации

| Cod./Code | Misura/Size | □/田 | € |
|-----------|-------------|-------|-----------|
| 156603003 | 3/8" | 10/60 | 8,35 |
| 156605003 | 1/2" | 10/60 | 9,70 |
| 156607003 | 3/4" | 10/60 | 13,18 |
| 156603004 | 3/8" | 10/60 | 8,08 (1) |
| 156605004 | 1/2" | 10/60 | 9,34 (1) |
| 156607004 | 3/4" | 10/60 | 12,24 (1) |

VALVOLE PER RADIATORI / RADIATOR VALVES

Valvole termostatiche / Thermostatic valves

JUPITER DETENTORE/LOCKSHIELD - Attacco tubo ferro / Iron pipe connection

Detentore per valvole Saturn, attacco tubo ferro, bocchettone con/senza autotenuta, nichelata

Straight heavy lockshield for Saturn valves, iron pipe connection, with/without auto-seal tail piece, nickel plated

Rücklaufverschraubung für Saturn - Ventile, Stutzen mit/ohne Selbstdichtung, vernickelt

Coude de réglage pour vanne Saturn, fixation PEX, multicouche et tube en cuivre, raccord autoétanche ou non étanche, nickelée

Усиленный отсекающий клапан, соединение для стальной трубы, патрубок с / без самогерметизации, никелированный

IVR 553 - IVR 553/2



IVR 553

IVR 553/2

A squadra

Angle lockshield

Eckförmige Rücklaufverschraubung

A équerre

Угловой

| Cod./Code | Misura/Size | □/田 | € | |
|-----------|-------------|--------|-------|-----|
| 155303000 | 3/8" | 10/120 | 5,38 | |
| 155305000 | 1/2" | 10/120 | 7,23 | |
| 155307000 | 3/4" | 10/60 | 10,01 | |
| 155303002 | 3/8" | 10/120 | 5,11 | (1) |
| 155305002 | 1/2" | 10/120 | 6,87 | (1) |
| 155307002 | 3/4" | 10/60 | 9,08 | (1) |

(1) 553/2 - Art. con bocchettone senza autotenuta

(1) 553/2 - Item with tail piece without auto-seal

(1) 553/2 - Art. Ventil mit Stutzen ohne Selbstdichtung

(1) 553/2 - Art. avec raccord non étanche

(1) 553/2 - Клапан с патрубком без самогерметизации

IVR 551 - IVR 551/2



IVR 551

IVR 551/2

Dritto

Straight lockshield

Gerade Rücklaufverschraubung

Droit

Прямой

| Cod./Code | Misura/Size | □/田 | € | |
|-----------|-------------|--------|-------|-----|
| 155103000 | 3/8" | 10/120 | 5,86 | |
| 155105000 | 1/2" | 10/120 | 8,39 | |
| 155107000 | 3/4" | 10/60 | 11,08 | |
| 155103002 | 3/8" | 10/120 | 5,59 | (1) |
| 155105002 | 1/2" | 10/120 | 8,03 | (1) |
| 155107002 | 3/4" | 10/60 | 10,14 | (1) |

(1) 551/2 - Art. con bocchettone senza autotenuta

(1) 551/2 - Item with tail piece without auto-seal

(1) 551/2 - Art. Ventil mit Stutzen ohne Selbstdichtung

(1) 551/2 - Art. avec raccord non étanche

(1) 551/2 - Клапан с патрубком без самогерметизации

VALVOLE PER RADIATORI / RADIATOR VALVES

Valvole termostatiche / Thermostatic valves

SATURN - Attacco PEX/Rame/PEX-AL-PEX / PEX/copper/PEX-AL-PEX



Valvola termostaticizzabile, attacco PEX, multistrato e tubo rame, bocchettone autotenuta, nichelata
Straight thermostatic valve, PEX, multilayer and copper pipe connection, auto-seal tail piece, nickel plated
Thermostatventil, gerade, mit Anschluss für PEX, Mehrschicht und Kupferrohr, selbstdichtender Stutzen, vernickelt
Vannes thermostatizables fixation pour tubes PEX, multicouche et en cuivre, raccord autoétanche, nickelée
Никелированный термостатический клапан, соединение для труб: медной, PEX и многослойной, самогерметизирующий патрубок

IVR 563 - IVR 563/2



IVR 563

IVR 563/2

A squadra con volantino manuale
Angle valve with manual handle
Eckförmig mit Handrad
Equerre avec volant manuel
Угловой клапан с ручным управлением

| Cod./Code | Misura/Size | Attacco/Connection | □/田 | € |
|-----------|-------------|--------------------|-------|----------|
| 156303180 | 3/8" | 24-19 | 10/60 | 8,20 |
| 156305180 | 1/2" | 24-19 | 10/60 | 9,10 |
| 156303160 | 3/8" | 1/2" | 10/60 | 9,01 |
| 156305160 | 1/2" | 1/2" | 10/60 | 9,07 |
| 156303182 | 3/8" | 24-19 | 10/60 | 7,93 (1) |
| 156305182 | 1/2" | 24-19 | 10/60 | 8,72 (1) |
| 156303162 | 3/8" | 1/2" | 10/60 | 8,75 (1) |
| 156305162 | 1/2" | 1/2" | 10/60 | 8,71 (1) |

- (1) 563/2 - Art. con bocchettone senza autotenuta
- (1) 563/2 - Item with tail piece without auto-seal
- (1) 563/2 - Art. Ventil mit Stutzen ohne Selbstdichtung
- (1) 563/2 - Art. avec raccord non étanche
- (1) 563/2 - Клапан с патрубком без самогерметизации

IVR 563/3 - IVR 563/4 PREREGOLAZIONE / PRESETTING



IVR 563/3

IVR 563/4

Con prerregolazione, a squadra con volantino manuale
Angle valve with presetting and with manual handle
Eckförmige Verschraubung mit Voreinstellung und Handrad
Avec préréglage, équerre avec volant manuel
Угловой клапан для радиаторов с преднастройкой и ручным управлением

| Cod./Code | Misura/Size | Attacco/Connection | □/田 | € |
|-----------|-------------|--------------------|-------|----------|
| 156303183 | 3/8" | 24-19 | 10/60 | 8,62 |
| 156305183 | 1/2" | 24-19 | 10/60 | 9,52 |
| 156303163 | 3/8" | 1/2" | 10/60 | 10,02 |
| 156305163 | 1/2" | 1/2" | 10/60 | 9,52 |
| 156303184 | 3/8" | 24-19 | 10/60 | 8,36 (1) |
| 156305184 | 1/2" | 24-19 | 10/60 | 9,16 (1) |
| 156303164 | 3/8" | 1/2" | 10/60 | 9,19 (1) |
| 156305164 | 1/2" | 1/2" | 10/60 | 9,16 (1) |

- (1) 563/4 - Art. con bocchettone senza autotenuta
- (1) 563/4 - Item with tail piece without auto-seal
- (1) 563/4 - Art. Ventil mit Stutzen ohne Selbstdichtung
- (1) 563/4 - Art. avec raccord non étanche
- (1) 563/4 - Клапан с патрубком без самогерметизации

IVR 569 - IVR 569/2



IVR 569

IVR 569/2

A squadra con cappello di regolazione
Angle valve with operating plastic cap
Eckförmige Verschraubung mit Einstellkappe
A équerre, avec chapeau de réglage
Угловой клапан с регулирующим колпачком

| Cod./Code | Misura/Size | Attacco/Connection | □/田 | € |
|-----------|-------------|--------------------|--------|------|
| 156903180 | 3/8" | 24-19 | 10/120 | 7,33 |
| 156905180 | 1/2" | 24-19 | 10/120 | 8,23 |
| 156903160 | 3/8" | 1/2" | 10/120 | 8,16 |
| 156905160 | 1/2" | 1/2" | 10/120 | 8,22 |

- (1) 569/2 - Art. con bocchettone senza autotenuta
(1) 569/2 - Item with tail piece without auto-seal
(1) 569/2 - Art. Ventil mit Stutzen ohne Selbstdichtung
(1) 569/2 - Art. avec raccord non étanche
(1) 569/2 - Клапан с патрубком без самогерметизации

| | | | | | |
|-----------|------|-------|--------|------|-----|
| 156903182 | 3/8" | 24-19 | 10/120 | 7,06 | (1) |
| 156905182 | 1/2" | 24-19 | 10/120 | 7,87 | (1) |
| 156903162 | 3/8" | 1/2" | 10/120 | 7,89 | (1) |
| 156905162 | 1/2" | 1/2" | 10/120 | 7,86 | (1) |

IVR 569/3 - IVR 569/4 PREREGOLAZIONE / PRESETTING



IVR 569/3

IVR 569/4

Con prerregolazione, a squadra con cappello di regolazione
Angle valve with presetting, operating plastic cap
Eckförmige Verschraubung mit Voreinstellung und Einstellkappe
Avec pré-réglage, équerre avec chapeau de réglage
Угловой клапан с преднастройкой и регулирующим колпачком

| Cod./Code | Misura/Size | Attacco/Connection | □/田 | € |
|-----------|-------------|--------------------|--------|------|
| 156903183 | 3/8" | 24-19 | 10/120 | 7,75 |
| 156905183 | 1/2" | 24-19 | 10/120 | 8,65 |
| 156903163 | 3/8" | 1/2" | 10/120 | 8,58 |
| 156905163 | 1/2" | 1/2" | 10/120 | 8,65 |

- (1) 569/4 - Art. con bocchettone senza autotenuta
(1) 569/4 - Item with tail piece without auto-seal
(1) 569/4 - Art. Ventil mit Stutzen ohne Selbstdichtung
(1) 569/4 - Art. avec raccord non étanche
(1) 569/4 - Клапан с патрубком без самогерметизации

| | | | | | |
|-----------|------|-------|--------|------|-----|
| 156903184 | 3/8" | 24-19 | 10/120 | 7,49 | (1) |
| 156905184 | 1/2" | 24-19 | 10/120 | 8,29 | (1) |
| 156903164 | 3/8" | 1/2" | 10/120 | 8,32 | (1) |
| 156905164 | 1/2" | 1/2" | 10/120 | 8,29 | (1) |

IVR 571 - IVR 571/2



IVR 571

IVR 571/2

Reversa con cappello di regolazione
Reverse angle valve with operating plastic cap
Eckförmiges Umsteuerungsventil mit Einstellkappe
À corps inversé avec chapeau de réglage
Реверсивный угловой клапан с регулирующим колпачком

| Cod./Code | Misura/Size | Attacco/Connection | □/田 | € | |
|-----------|-------------|--------------------|-------|-------|-----|
| 157105180 | 1/2" | 24-19 | 10/60 | 10,17 | |
| 157105182 | 1/2" | 24-19 | 10/60 | 9,81 | (1) |

- (1) 571/2 - Art. con bocchettone senza autotenuta
(1) 571/2 - Item with tail piece without auto-seal
(1) 571/2 - Art. Ventil mit Stutzen ohne Selbstdichtung
(1) 571/2 - Art. avec raccord non étanche
(1) 571/2 - Клапан с патрубком без самогерметизации

IVR 571/3 - IVR 571/4

NEW



IVR 571/3

IVR 571/4

Reversa con preregolazione, con cappello di regolazione
Reverse valve with presetting and operating plastic cap
Umsteuerungsventil mit Voreinstellung, mit Einstellkappe
À corps inversé avec préreglage, avec chapeau de réglage
Реверсивный термостатический клапан с регулирующим колпачком.

- (1) 571/4 - Art. con bocchettone senza autotenuta
(1) 571/4 - Item with tail piece without auto-seal
(1) 571/4 - Art. Ventil mit Stutzen ohne Selbstdichtung
(1) 571/4 - Art. avec raccord non étanche
(1) 571/4 - Клапан с патрубком без самогерметизации

| Cod./Code | Misura/Size | Attacco/Connection | □/田 | € |
|-----------|-------------|--------------------|-------|-----------|
| 157105183 | 1/2" | 24-19 | 10/60 | 10,46 |
| 157105184 | 1/2" | 24-19 | 10/60 | 10,10 (1) |

IVR 562 - IVR 562/2



IVR 562

IVR 562/2

Dritta con volantino manuale
Straight with manual handle
Gerade mit Handrad
Droit avec volant manuel
Прямой клапан с ручным управлением

- (1) 562/2 - Art. con bocchettone senza autotenuta
(1) 562/2 - Item with tail piece without auto-seal
(1) 562/2 - Art. Ventil mit Stutzen ohne Selbstdichtung
(1) 562/2 - Art. avec raccord non étanche
(1) 562/2 - Клапан с патрубком без самогерметизации

| Cod./Code | Misura/Size | Attacco/Connection | □/田 | € |
|-----------|-------------|--------------------|-------|----------|
| 156203180 | 3/8" | 24-19 | 10/60 | 9,40 |
| 156205180 | 1/2" | 24-19 | 10/60 | 9,89 |
| 156203160 | 3/8" | 1/2" | 10/60 | 9,20 |
| 156205160 | 1/2" | 1/2" | 10/60 | 9,92 |
| 156203182 | 3/8" | 24-19 | 10/60 | 9,12 (1) |
| 156205182 | 1/2" | 24-19 | 10/60 | 9,53 (1) |
| 156203162 | 3/8" | 1/2" | 10/60 | 8,93 (1) |
| 156205162 | 1/2" | 1/2" | 10/60 | 9,09 (1) |

IVR 562/3 - IVR 562/4 PREREGOLAZIONE / PRESETTING



IVR 562/3

IVR 562/4

Con preregolazione, dritta con volantino manuale
Straight valve with presetting and with manual handle
Gerade Verschraubung mit Voreinstellung und Handrad
Avec préreglage, equerre avec volant manuel
Прямой клапан для радиаторов с преднастройкой и ручным управлением

- (1) 562/4 - Art. con bocchettone senza autotenuta
(1) 562/4 - Item with tail piece without auto-seal
(1) 562/4 - Art. Ventil mit Stutzen ohne Selbstdichtung
(1) 562/4 - Art. avec raccord non étanche
(1) 562/4 - Клапан с патрубком без самогерметизации

| Cod./Code | Misura/Size | Attacco/Connection | □/田 | € |
|-----------|-------------|--------------------|-------|-----------|
| 156203183 | 3/8" | 24-19 | 10/60 | 9,83 |
| 156205183 | 1/2" | 24-19 | 10/60 | 10,31 |
| 156203163 | 3/8" | 1/2" | 10/60 | 9,62 |
| 156205163 | 1/2" | 1/2" | 10/60 | 10,37 |
| 156203184 | 3/8" | 24-19 | 10/60 | 9,56 (1) |
| 156205184 | 1/2" | 24-19 | 10/60 | 9,95 (1) |
| 156203164 | 3/8" | 1/2" | 10/60 | 9,36 (1) |
| 156205164 | 1/2" | 1/2" | 10/60 | 10,01 (1) |

IVR 568 - IVR 568/2



Dritta con cappello di regolazione
 Straight valve with operating plastic cap
 Gerade Verschraubung mit Einstellkappe
 Droite avec chapeau de réglage
 Прямой клапан с регулирующим колпачком

| Cod./Code | Misura/Size | Attacco/Connection | □/田 | € |
|-----------|-------------|--------------------|-------|------|
| 156803180 | 3/8" | 24-19 | 10/60 | 8,55 |
| 156805180 | 1/2" | 24-19 | 10/60 | 9,04 |
| 156803160 | 3/8" | 1/2" | 10/60 | 8,34 |
| 156805160 | 1/2" | 1/2" | 10/60 | 9,09 |

- (1) 568/2 - Art. con bocchettone senza autotenuta
 (1) 568/2 - Item with tail piece without auto-seal
 (1) 568/2 - Art. Ventil mit Stutzen ohne Selbstdichtung
 (1) 568/2 - Art. avec raccord non étanche
 (1) 568/2 - Клапан с патрубком без самогерметизации

| | | | | | |
|-----------|------|-------|-------|------|-----|
| 156803182 | 3/8" | 24-19 | 10/60 | 8,28 | (1) |
| 156805182 | 1/2" | 24-19 | 10/60 | 8,66 | (1) |
| 156803162 | 3/8" | 1/2" | 10/60 | 8,08 | (1) |
| 156805162 | 1/2" | 1/2" | 10/60 | 8,73 | (1) |

IVR 568/3 - IVR 568/4 PREREGOLAZIONE / PRESETTING



IVR 568/3

IVR 568/4

Con prerregolazione, dritta con cappello di regolazione
 Straight valve with presetting, operating plastic cap
 Gerade Verschraubung mit Voreinstellung und Einstellkappe
 Avec préréglage, droite avec chapeau de réglage
 Прямой клапан с преднастройкой, регулирующий колпачок

| Cod./Code | Misura/Size | Attacco/Connection | □/田 | € |
|-----------|-------------|--------------------|-------|------|
| 156803183 | 3/8" | 24-19 | 10/60 | 8,97 |
| 156805183 | 1/2" | 24-19 | 10/60 | 9,46 |
| 156803163 | 3/8" | 1/2" | 10/60 | 8,77 |
| 156805163 | 1/2" | 1/2" | 10/60 | 9,51 |

- (1) 568/4 - Art. con bocchettone senza autotenuta
 (1) 568/4 - Item with tail piece without auto-seal
 (1) 568/4 - Art. Ventil mit Stutzen ohne Selbstdichtung
 (1) 568/4 - Art. avec raccord non étanche
 (1) 568/4 - Клапан с патрубком без самогерметизации

| | | | | | |
|-----------|------|-------|-------|------|-----|
| 156803184 | 3/8" | 24-19 | 10/60 | 8,71 | (1) |
| 156805184 | 1/2" | 24-19 | 10/60 | 9,10 | (1) |
| 156803164 | 3/8" | 1/2" | 10/60 | 8,50 | (1) |
| 156805164 | 1/2" | 1/2" | 10/60 | 9,15 | (1) |

VALVOLE PER RADIATORI / RADIATOR VALVES

Valvole termostatiche / Thermostatic valves

SATURN-COAXIAL

Attacco Tubo Ferro



Valvola coassiale termostattizzabile per radiatori con volantino manuale. Attacchi tubo ferro. Bocchettone con autotenuta. Impieghi: adatte per utilizzo su ogni tipo di radiatore
Thermostatic coaxial valve with plastic cap, iron pipe connection, tail piece with auto-seal. Use: suitable for any type of radiator
Koaxial-Thermostatventil für Heizkörper mit Handrad. Anschlussstutzen mit Selbstdichtung für Eisenrohr. Sie können auf jede Sorte von Heizkörper eingesetzt werden
Vanne coaxiale thermostatizable pour radiateurs avec volant manuel. Fixation tube fer. Raccord avec auto-étanche. Usage: adapté à tout type de radiateur
Коаксиальный термостатический радиаторный клапан с регулирующим пластиковым колпачком. Соединение для стальной трубы. Самогерметизирующийся патрубков. Сфера применения: может устанавливаться на любой тип радиатора

IVR 530 - IVR 530/2



3 vie, attacco tubo ferro, con cappellino di regolazione e autotenuta
3 ways, iron pipe connections, with operating plastic cap and auto-seal
3 Wege, Anschluss für Eisenrohr, mit Einstellkappe und Selbstdichtung
3 voies, fixation tube fer, avec chapeau de réglage et auto-étanche
Трехходовой, соединение для стальной трубы, с регулирующим колпачком и самогерметизацией

(1) 530/2 - Con bocchettone senza autotenuta
(1) 530/2 - Item with tail piece without auto-seal
(1) 530/2 - Artikel Ventil mit rohverschraubung ohne Selbstdichtung
(1) 530/2 - Article avec raccord sans étanche
(1) 530/2 - с накидной гайкой без самогерметизации

| Cod./Code | Misura/Size | □/田 | € |
|-----------|-------------|-------|-----------|
| 153003000 | 3/8" | 10/60 | 10,46 |
| 153005000 | 1/2" | 10/40 | 12,50 |
| 153003002 | 3/8" | 10/60 | 10,00 (1) |
| 153005002 | 1/2" | 10/40 | 11,90 (1) |

IVR 530 AD



Adattatore per tubo PEX/Rame/PEX-AL-PEX
Adapter for PEX, multilayer and copper pipe
PEX, Kupferrohr und Mehrschichtrohr Anschlussadapter
Adaptateur pour tube PEX, multi-couches ou cuivre.
Адаптер для труб: металлопластиковой, медной и PEX

| Cod./Code | Misura/Size | Attacco/Connection | □/田 | € |
|-----------|-------------|--------------------|--------|------|
| 153003024 | 3/8" | 24-19 | 10/150 | 2,27 |
| 153005024 | 1/2" | 24-19 | 10/150 | 2,21 |

VALVOLE PER RADIATORI / RADIATOR VALVES

Valvole termostatiche / Thermostatic valves

JUPITER DETENTORE/LOCKSHIELD - Attacco PEX/Rame/PEX-AL-PEX / PEX/copper/PEX-AL-PEX

Detentore, attacco PEX, multistrato e tubo rame, bocchettone autotenuta, nichelato

Heavy lockshield, PEX, multilayer and copper pipe connection, auto-seal tail piece, nickel plated

Rücklaufverschraubung PEX, Mehrschicht - und Kupferrohr-Anschluss, selbstdichtender Stutzen, vernickelt

Coude de réglage, fixation PEX, multicouche et tube en cuivre, raccord autoétanche, nickelé

Усиленный отсекающий клапан; соединения для трубы PEX, медной и многослойной труб, патрубок с самогерметизацией, никелированный

IVR 557 - IVR 557/2



IVR 557

IVR 557/2

A squadra
Angle lockshield
Eckförmige Rücklaufverschraubung
A équerre
Угловой

| Cod./Code | Misura/Size | Attacco/Connection | □/田 | € | |
|-----------|-------------|--------------------|--------|------|-----|
| 155703180 | 3/8" | 24-19 | 10/120 | 5,44 | |
| 155705180 | 1/2" | 24-19 | 10/120 | 7,01 | |
| 155703160 | 3/8" | 1/2" | 10/120 | 6,64 | |
| 155705160 | 1/2" | 1/2" | 10/120 | 7,14 | |
| 155703182 | 3/8" | 24-19 | 10/120 | 5,17 | (1) |
| 155705182 | 1/2" | 24-19 | 10/120 | 6,65 | (1) |
| 155703162 | 3/8" | 1/2" | 10/120 | 6,38 | (1) |
| 155705162 | 1/2" | 1/2" | 10/120 | 6,78 | (1) |

(1) 557/2 - Art. con bocchettone senza autotenuta

(1) 557/2 - Item with tail piece without auto-seal

(1) 557/2 - Art. Ventil mit Stutzen ohne Selbstdichtung

(1) 557/2 - Art. avec raccord non étanche

(1) 557/2 - Клапан с патрубком без самогерметизации

IVR 555 - IVR 555/2



IVR 555

IVR 555/2

Dritto
Straight lockshield
Gerade Rücklaufverschraubung
Droit
Прямой

| Cod./Code | Misura/Size | Attacco/Connection | □/田 | € | |
|-----------|-------------|--------------------|--------|------|-----|
| 155503180 | 3/8" | 24-19 | 10/120 | 6,44 | |
| 155505180 | 1/2" | 24-19 | 10/120 | 8,00 | |
| 155503160 | 3/8" | 1/2" | 10/120 | 6,51 | |
| 155505160 | 1/2" | 1/2" | 10/120 | 8,02 | |
| 155503182 | 3/8" | 24-19 | 10/120 | 6,17 | (1) |
| 155505182 | 1/2" | 24-19 | 10/120 | 7,64 | (1) |
| 155503162 | 3/8" | 1/2" | 10/120 | 6,25 | (1) |
| 155505162 | 1/2" | 1/2" | 10/120 | 7,66 | (1) |

(1) 555/2 - Art. con bocchettone senza autotenuta

(1) 555/2 - Item with tail piece without auto-seal

(1) 555/2 - Art. Ventil mit Stutzen ohne Selbstdichtung

(1) 555/2 - Art. avec raccord non étanche

(1) 555/2 - Клапан с патрубком без самогерметизации



KIT TERMOSTATICI / THERMOSTATIC KITS

Kit termostatico composto da valvola Saturn, detentore Jupiter e testa termostatica a liquido Sunny

Thermostatic kit: Saturn valve, Jupiter lockshield and Sunny thermostatic head with liquid sensor

Gruppe bestehend aus Thermostatventil Saturn, Rücklaufverschraubung Jupiter und thermostatischem Kopf Sunny

Kit thermostatique composé de vanne Saturn, coude de réglage Jupiter et tête thermostatique avec capteur liquide Sunny

Термостатический комплект состоящий из клапана Saturn, отсекающего вентиля Jupiter и термостатической головки Sunny с жидкостным сенсором.

IVR 567 KIT

NEW



A squadra, per attacco tubo ferro

Angle, iron pipe connection

Eckförmig, Anschluss für Eisenrohr

Équerre, fixation tube en fer

Угловой вентиль, соединение для железной трубы

| Cod./Code | Misura/Size | □/田 | € |
|------------|-------------|------|-------|
| 1567K03000 | 3/8" | 1/15 | 21,63 |
| 1567K05000 | 1/2" | 1/15 | 24,47 |
| 1567K07000 | 3/4" | 1/15 | 30,50 |

IVR 566 KIT

NEW



Dritto, per attacco tubo ferro

Straight, iron pipe connection

Gerade, Anschluss für Eisenrohr

Droit, fixation tube en fer

Прямой вентиль, соединение для железной трубы

| Cod./Code | Misura/Size | □/田 | € |
|------------|-------------|------|-------|
| 1566K03000 | 3/8" | 1/15 | 22,64 |
| 1566K05000 | 1/2" | 1/15 | 26,52 |
| 1566K07000 | 3/4" | 1/15 | 32,64 |

IVR 569 KIT

NEW



A squadra, attacco tubo rame, PEX e multistrato

Angle, PEX, multilayer and copper pipe connection

Eckförmig, Anschluss für Kupfer, PEX und Mehrschichtrohr

Équerre, fixation tube en cuivre, PEX et multicouche

Угловой вентиль, соединение для медной, PEX и многослойной трубы

| Cod./Code | Misura/Size | Attacco/Connection | □/田 | € |
|------------|-------------|--------------------|------|-------|
| 1569K03160 | 3/8" | 1/2" | 1/15 | 23,66 |
| 1569K05160 | 1/2" | 1/2" | 1/15 | 24,22 |
| 1569K03180 | 3/8" | 24-19 | 1/15 | 21,62 |
| 1569K05180 | 1/2" | 24-19 | 1/15 | 24,09 |

IVR 568 KIT

NEW



Dritto, attacco tubo rame, PEX e multistrato

Straight, PEX, multilayer and copper pipe connection

Gerade, Anschluss für Kupfer, PEX und Mehrschichtrohr

Droit, fixation tube en cuivre, PEX et multicouche

Прямой вентиль, соединение для медной, PEX и многослойной трубы

| Cod./Code | Misura/Size | Attacco/Connection | □/田 | € |
|------------|-------------|--------------------|------|-------|
| 1568K03160 | 3/8" | 1/2" | 1/15 | 23,71 |
| 1568K05160 | 1/2" | 1/2" | 1/15 | 25,96 |
| 1568K03180 | 3/8" | 24-19 | 1/15 | 23,84 |
| 1568K05180 | 1/2" | 24-19 | 1/15 | 25,89 |

IVR 570 KIT

NEW



A squadra, per attacco tubo ferro
 Angle, iron pipe connection
 Eckförmig, Anschluss für Eisenrohr
 Équerre, fixation tube en fer
 Угловой вентиль, соединение для железной трубы

| Cod./Code | Misura/Size | □/田 | € |
|------------|-------------|------|-------|
| 1570K05000 | 1/2" | 1/15 | 26,26 |

IVR 571 KIT

NEW



A squadra, attacco tubo rame, PEX e multistrato
 Angle, PEX, multilayer and copper pipe connection
 Eckförmig, Anschluss für Kupfer, PEX und Mehrschichtrohr
 Équerre, fixation tube en cuivre, PEX et multicouche
 Угловой вентиль, соединение для медной, PEX и многослойной трубы

| Cod./Code | Misura/Size | Attacco/Connection | □/田 | € |
|------------|-------------|--------------------|------|-------|
| 1571K05180 | 1/2" | 24-19 | 1/15 | 26,04 |

IVR 436



Kit valvole termostattabili a squadra per tubo rame, PEX e multistrato, composto da: valvola SATURN e detentore JUPITER, volantino manuale, 2+2 DX/SX riduzioni con guarnizione, valvola scarico aria, tappo ottone con cappuccio bianco

Thermostatic angle radiator valve kit for copper, PEX and multilayer pipe, includes: SATURN radiator valve and JUPITER lockshield, manual handle, 2+2 DX/SX reductions, manual air vent valve, brass plug with white plastic cap

KIT (Garnitur) Thermostatventile, eckförmig für Kupfer-, PEX- und Mehrschichtrohr, bestehend aus: Ventil SATURN und Rücklaufverschraubung JUPITER, Handrad, 2+2 Reduzierstücke rechts/links mit Dichtung, Entlüftungsventil, Messingdeckel mit weißer Kappe

Kit vannes thermostatisables équerre pour tube en cuivre, PEX et multicouche, composé de: vanne SATURN et coude de réglage JUPITER, volant manuel, 2+2 DX/SX réductions avec joint, vanne évacuation aria, bouchon en laiton avec capuchon blanc

Комплект термостатических угловых клапанов для медной, многослойной и трубы PEX включает: радиаторный клапан Saturn и отсекающий клапан Jupiter, 2 + 2 пр./лев. футорки с прокладками, ручной воздухоотводчик, заглушки из латуни с белым пластиковыми колпачками

| Cod./Code | Misura/Size | Attacco/Connection | □/田 | € |
|-----------|-------------|--------------------|-----|-------|
| 143603682 | 3/8" | 24-19 | 1/7 | 23,76 |
| 143605682 | 1/2" | 24-19 | 1/7 | 26,55 |

VALVOLE TERMOSTATICHE / THERMOSTATIC VALVES

Componenti e ricambi / Components and spare parts



IVR 458



Vitone per valvola termostatica

TRV bonnet

Einsatz für Thermostatventil im Verteiler

Mécanisme pour robinetterie thermostatizable

Вставка для термостатического клапана

| Cod./Code | Misura/Size | | □/田 | € |
|-----------|-------------|--|--------|------|
| 145800005 | 1/2" | VITONE VAL TERMOST COMPL | 50/600 | 2,62 |
| 145800006 | 3/4" | VITONE VAL TERMOST COMPL | 50/600 | 2,97 |
| 145800020 | 1" | VITONE TERM COLL. INX ASS | 50/300 | 3,90 |
| 145800115 | 1/2" | VITONE PRE-REGOLAZ COMPL | 50/600 | 2,87 |
| 145800117 | 3/4" | VITONE PRE-REGOLAZ COMPL | 50/600 | 3,27 |
| 145800155 | 1/2" | VITONE TERM FLUSSO INVERSO / REVERSE FLOW | 50/600 | 4,80 |
| 145800157 | 3/4" | VITONE TERM FLUSSO INVERSO / REVERSE FLOW | 50/600 | 5,39 |
| 145800165 | 1/2" | VITONE TERM PRE-REG FLUSSO INVERSO / PRESET-REVERSE FLOW | 50/600 | 4,86 |
| 145800167 | 3/4" | VITONE TERM PRE-REG FLUSSO INVERSO / PRESET-REVERSE FLOW | 50/600 | 5,51 |

IVR 459



Chiave per sostituire vitone

Allen key for bonnets replacement

Montageblock für den Austausch (von Thermostatventil-Innenteilen unter Druck)

Clef pour changement du mécanisme

Ключ для замены кран-буksы без слива системы

| Cod./Code | Misura/Size | □/田 | € |
|-----------|-------------|-----|--------|
| 338300171 | 1/6 | | 356,88 |

IVR 457



Adattatore per montaggio testa termostatica DNF
 Adapter for mounting DNF thermostatic head
 Adapter für den Thermostatkopf DNF
 Adaptateur pour le montage de la tête thermostatique DNF
 Адаптер для монтажа термостатической головки DNF

| Cod./Code | Misura/Size | □/田 | € |
|-----------|-------------|--------|------|
| 145700500 | | 10/500 | 0,35 |

IVR 324



Bocchettone per Saturn e Mercury - Con autotenuta
 Tail piece for Saturn e Mercury - with auto-seal
 Rohrverschraubung für Saturn und Mercury - mit Selbstdichtung
 Raccord pour Saturn et Mercury - avec autoétanche
 Самогерметизирующий патрубок для моделей Saturn и Mercury

| Cod./Code | Misura/Size | □/田 | € |
|-----------|-------------|--------|------|
| 132403051 | 3/8" x 1/2" | 20/240 | 2,08 |
| 132405071 | 1/2" x 3/4" | 20/240 | 2,66 |
| 132407101 | 3/4" x 1" | 10/120 | 4,25 |

IVR 326



Bocchettone per Saturn e Mercury senza autotenuta - (codolo + calotta)
 Tail piece for Saturn e Mercury with auto-seal (tail piece and nut)
 Rohrverschraubung für Saturn und Mercury mit Selbstdichtung (Verschraubung und Nuss)
 Raccord pour Saturn et Mercury avec autoétanche (queue et calotte)
 Патрубок без самогерметизации для моделей Saturn и Mercury (хвостовая часть с гайкой)

| Cod./Code | Misura/Size | □/田 | € |
|-----------|-------------|--------|------|
| 132603051 | 3/8" x 1/2" | 10/120 | 2,01 |
| 132605071 | 1/2" x 3/4" | 20/240 | 2,46 |
| 132607101 | 3/4" x 1" | 10/120 | 3,47 |
| 132610121 | 1" x 1"1/4" | 10/60 | 5,70 |

IVR 325



Bocchettone telescopico, nichelato
 Telescopic tail piece, nickel-plated
 Anschluss-Stutzen teleskopisch - vernickelt
 Raccord télescopique - nickelé
 Телескопическое соединение, никелированное

| Cod./Code | Misura/Size | □/田 | € |
|-----------|-------------|--------|------|
| 132503051 | 3/8" x 1/2" | 20/400 | 2,20 |
| 132505071 | 1/2" x 3/4" | 10/200 | 3,13 |
| 132507101 | 3/4" x 1" | 5/100 | 5,54 |

IVR 594



Volantino manuale. ABS colore RAL 9010 - per SATURN, AVANT FLOOR, IVR INOX
Manual handle. ABS Ral 9010 colour - for SATURN, AVANT FLOOR, IVR INOX
ABS Handrad, RAL9010 - für SATURN, AVANT FLOOR, IVR INOX
Volant manuel ABS couleur RAL 9010 - pour SATURN, AVANT FLOOR, IVR INOX
Колпачок для ручной регулировки, ABS цвет Ral 9010 - для SATURN, AVANT FLOOR, IVR INOX.

| Cod./Code | Misura/Size | □/田 | € |
|-----------|-------------|--------|------|
| 159400001 | M30 x 1.5 | 10/120 | 1,43 |

IVR 596



Cappello di regolazione per SATURN, AVANT FLOOR, IVR INOX - ABS Colore RAL 9010
Operating plastic cap for SATURN, AVANT FLOOR, IVR INOX - ABS Ral 9010 colour
ABS Einstellkappe für SATURN, AVANT FLOOR, IVR INOX - RAL 9010
Chapeau de réglage pour SATURN, AVANT FLOOR, IVR INOX - ABS Couleur RAL 9010
Регулирующий колпачок для SATURN, AVANT FLOOR, IVR INOX - ABS цвет Ral 9010

| Cod./Code | Misura/Size | □/田 | € |
|-----------|-------------|--------|------|
| 159600001 | M30 x 1.5 | 20/360 | 0,38 |

IVR 588



Cappuccio per detentori JUPITER - ABS colore RAL 9010
Plug for lockshield JUPITER - ABS colour Ral 9010
Kappe für Rücklaufverschraubungen JUPITER - ABS RAL 9010
Capuchon pour coudes de réglages JUPITER - ABS couleur RAL 9010
Колпачок для отсекающего клапана JUPITER - ABS цвет RAL 9010

| Cod./Code | Misura/Size | □/田 | € |
|-----------|-------------|--------|------|
| 158803001 | 3/8" | 10/240 | 0,51 |
| 158805001 | 1/2" | 10/240 | 0,56 |
| 158805001 | 3/4" | 10/240 | 0,56 |

IVR 595



Anello anti manomissione
Anti-temper ring
Ring - abschließbar
Anneau contre sabotage
Защитное кольцо

| Cod./Code | Misura/Size | □/田 | € |
|-----------|-------------|-------|------|
| 159500001 | M30 x 1,5 | 10/40 | 8,48 |

VALVOLE PER RADIATORI / RADIATOR VALVES

Valvole manuali / Manuale valves

MERCURY - Attacco tubo ferro / Iron pipe connection

Valvola manuale per radiatori, attacco tubo ferro, bocchettone con/senza autotenuta, nichelata
 Manual radiator valve, iron pipe connection, with/without auto-seal tail piece, nickel plated
 Manuelles Heizkörperventil, Anschluss für Eisenrohr, Stutzen mit/ohne Selbstdichtung - vernickelt
 Robinet manuel pour radiateurs, fixation tube fer, raccord autoétanche ou non étanche - nickelée
 Ручной радиаторный клапан, соединение для стальной трубы, с патрубком с/без самогерметизации

IVR 536 - IVR 536/2



IVR 536

IVR 536/2

A squadra con volantino manuale
 Angle valve with manual handle
 Eckförmig mit Handrad
 Equerre avec volant manuel
 Угловой клапан с ручным управлением

| Cod./Code | Misura/Size | □/田 | € | |
|-----------|-------------|-------|------|-----|
| 153603000 | 3/8" | 10/60 | 5,73 | |
| 153605000 | 1/2" | 10/60 | 6,86 | |
| 153607000 | 3/4" | 10/40 | 9,37 | |
| 153603002 | 3/8" | 10/60 | 5,46 | (1) |
| 153605002 | 1/2" | 10/60 | 6,50 | (1) |
| 153607002 | 3/4" | 10/40 | 8,44 | (1) |

(1) 536/2 - Art. con bocchettone senza autotenuta
 (1) 536/2 - Item with tail piece without auto-seal
 (1) 536/2 - Art. Ventil mit Stutzen ohne Selbstdichtung
 (1) 536/2 - Art. avec raccord non étanche
 (1) 536/2 - Клапан с патрубком без самогерметизации

IVR 534 - IVR 534/2



IVR 534

IVR 534/2

Dritta con volantino manuale
 Straight with manual handle
 Gerade mit Handrad
 Droit avec Volant manuel
 Прямой клапан с ручным управлением

| Cod./Code | Misura/Size | □/田 | € | |
|-----------|-------------|-------|-------|-----|
| 153403000 | 3/8" | 10/60 | 6,15 | |
| 153405000 | 1/2" | 10/60 | 7,27 | |
| 153407000 | 3/4" | 10/40 | 10,24 | |
| 153403002 | 3/8" | 10/60 | 5,88 | (1) |
| 153405002 | 1/2" | 10/60 | 6,91 | (1) |
| 153407002 | 3/4" | 10/40 | 9,31 | (1) |

(1) 534/2 - Art. con bocchettone senza autotenuta
 (1) 534/2 - Item with tail piece without auto-seal
 (1) 534/2 - Art. Ventil mit Stutzen ohne Selbstdichtung
 (1) 534/2 - Art. avec raccord non étanche
 (1) 534/2 - Клапан с патрубком без самогерметизации

VALVOLE PER RADIATORI / RADIATOR VALVES

Valvole manuali / Manuale valves

MERCURY - Detentore attacco tubo ferro / Lockshield iron pipe connection



Detentore per radiatori, attacco tubo ferro, bocchettone con/senza autotenuta, nichelato
Lockshield, iron pipe connection, with/without auto-seal tail piece, nickel plated
Rücklaufverschraubung für Heizkörper, Anschluss für Eisenrohr, Stutzen mit/ohne Selbstdichtung, vernickelt
Coudes de réglages pour radiateurs, fixation tube fer, raccord autoétanche ou non étanche, nickelée
Отсекающий клапан для радиаторов, соединения для стальной трубы, патрубок с/без уплотнения, никелированный

IVR 537 - IVR 537/2



IVR 537

IVR 537/2

A squadra, con autotenuta
Angle valve with auto-seal tail piece
Eckförmig und selbstdichtend
A équerre avec autoétanche
Угловой клапан, патрубок с самогерметизацией

| Cod./Code | Misura/Size | □/田 | € | |
|-----------|-------------|--------|------|-----|
| 153703000 | 3/8" | 10/120 | 4,93 | |
| 153705000 | 1/2" | 10/120 | 5,95 | |
| 153707000 | 3/4" | 10/60 | 8,60 | |
| 153703002 | 3/8" | 10/120 | 4,67 | (1) |
| 153705002 | 1/2" | 10/120 | 5,59 | (1) |
| 153707002 | 3/4" | 10/60 | 7,68 | (1) |

- (1) 537/2 - Art. con bocchettone senza autotenuta
(1) 537/2 - Item with tail piece without auto-seal
(1) 537/2 - Art. Ventil mit Stutzen ohne Selbstdichtung
(1) 537/2 - Art. avec raccord non étanche
(1) 537/2 - Клапан с патрубком без самогерметизации

IVR 535 - IVR 535/2



IVR 535

IVR 535/2

Dritto, con autotenuta
Straight, with auto-seal tail piece
Gerade und selbstdichtend
Droite, avec autoétanche
Прямой отсекающий клапан с самогерметизацией

| Cod./Code | Misura/Size | □/田 | € | |
|-----------|-------------|--------|------|-----|
| 153503000 | 3/8" | 10/120 | 5,35 | |
| 153505000 | 1/2" | 10/120 | 6,50 | |
| 153507000 | 3/4" | 10/60 | 9,40 | |
| 153503002 | 3/8" | 10/120 | 5,09 | (1) |
| 153505002 | 1/2" | 10/120 | 6,14 | (1) |
| 153507002 | 3/4" | 10/60 | 8,48 | (1) |

- (1) 535/2 - Art. con bocchettone senza autotenuta
(1) 535/2 - Item with tail piece without auto-seal
(1) 535/2 - Art. Ventil mit Stutzen ohne Selbstdichtung
(1) 535/2 - Art. avec raccord non étanche
(1) 535/2 - Клапан с патрубком без самогерметизации

VALVOLE PER RADIATORI / RADIATOR VALVES

Valvole manuali / Manuale valves

MERCURY PLUS - Ispezionabili/Unscrewable - Attacco tubo ferro / Iron pipe connection

Valvola ispezionabile manuale a squadra per radiatori, attacco tubo ferro, bocchettone con/senza autotenuta, nichelata
Angle manual radiators valve, iron pipe connection, with/without auto-seal tail piece, nickel plated
Eckförmiges inspektionierbar manuelles Heizkörperventil, Anschluss für Eisenrohr, Stutzen mit/ohne Selbstdichtung, vernickelt
Vanne contrôlable manuelle équerre pour radiateurs, fixation à souder pour tube en cuivre, raccord autoétanche ou non étanche, nickelée
Ручной радиаторный клапан, соединение для стальной трубы, патрубок с/без самогерметизации, никелированный

IVR 548 - IVR 548/2



IVR 548



IVR 548/2

A squadra con volantino manuale
Angle valve with manual handle
Eckförmig mit Handrad
Equerre avec volant manuel
Угловой клапан с ручным управлением

(1) 548/2 - Art. con bocchettone senza autotenuta
(1) 548/2 - Item with tail piece without auto-seal
(1) 548/2 - Art. Ventil mit Stutzen ohne Selbstdichtung
(1) 548/2 - Art. avec raccord non étanche
(1) 548/2 - Клапан с патрубком без самогерметизации



| Cod./Code | Misura/Size | □/田 | € |
|-----------|-------------|-------|----------|
| 154805000 | 1/2" | 10/60 | 7,51 |
| 154807000 | 3/4" | 10/60 | 9,95 |
| 154805002 | 1/2" | 10/60 | 7,15 (1) |
| 154807002 | 3/4" | 10/60 | 9,02 (1) |

IVR 546 - IVR 546/2



IVR 546



IVR 546/2

Dritta con volantino manuale
Straight with manual handle
Gerade mit Handrad
Droit avec volant manuel
Прямой клапан с ручным управлением

(1) 546/2 - Art. con bocchettone senza autotenuta
(1) 546/2 - Item with tail piece without auto-seal
(1) 546/2 - Art. Ventil mit Stutzen ohne Selbstdichtung
(1) 546/2 - Art. avec raccord non étanche
(1) 546/2 - Клапан с патрубком без самогерметизации



| Cod./Code | Misura/Size | □/田 | € |
|-----------|-------------|-------|----------|
| 154605000 | 1/2" | 10/60 | 8,02 |
| 154607000 | 3/4" | 10/40 | 10,79 |
| 154605002 | 1/2" | 10/60 | 7,66 (1) |
| 154607002 | 3/4" | 10/40 | 9,85 (1) |

VALVOLE PER RADIATORI / RADIATOR VALVES

Valvole manuali / Manuale valves

MERCURY PLUS - Detentore attacco tubo ferro / Lockshield iron pipe connection



Detentore ispezionabile a squadra per radiatori, attacco tubo ferro, bocchettone con/senza autotenuta, nichelata
Angle lockshield, iron pipe connection, with/without auto-seal tail piece, nickel plated
Eckförmiges Rücklaufverschraubung, inspektionierbar, für Heizkörper, Anschluss für Kupferrohr, Stutzen mit/ohne Selbstdichtung, vernickelt
Coude de réglage controlable étanche, fixation à souder pour tube en cuivre, raccord autoétanche ou non étanche, nickelée
Отсекающий угловой клапан, соединения для стальной трубы, патрубком с / без самогерметизации, никелированный

IVR 549 - IVR 549/2



A squadra
Angle lockshield
Eckförmige Rücklaufverschraubung
A équerre
Угловой клапан

IVR 549

IVR 549/2

- (1) 549/2 - Art. con bocchettone senza autotenuta
- (1) 549/2 - Item with tail piece without auto-seal
- (1) 549/2 - Art. Ventil mit Stutzen ohne Selbstdichtung
- (1) 549/2 - Art. avec raccord non étanche
- (1) 549/2 - Клапан с патрубком без самогерметизации

| Cod./Code | Misura/Size | □/⊕ | € | |
|-----------|-------------|--------|------|-----|
| 154905000 | 1/2" | 10/120 | 6,21 | |
| 154907000 | 3/4" | 10/60 | 8,92 | |
| 154905002 | 1/2" | 10/120 | 5,85 | (1) |
| 154907002 | 3/4" | 10/60 | 7,98 | (1) |

IVR 547 - IVR 547/2



Dritto
Straight lockshield
Gerade Rücklaufverschraubung
Droit
Прямой клапан

IVR 547

IVR 547/2

- (1) 547/2 - Art. con bocchettone senza autotenuta
- (1) 547/2 - Item with tail piece without auto-seal
- (1) 547/2 - Art. Ventil mit Stutzen ohne Selbstdichtung
- (1) 547/2 - Art. avec raccord non étanche
- (1) 547/2 - Клапан с патрубком без самогерметизации

| Cod./Code | Misura/Size | □/⊕ | € | |
|-----------|-------------|--------|------|-----|
| 154705000 | 1/2" | 10/120 | 6,74 | |
| 154707000 | 3/4" | 10/60 | 9,74 | |
| 154705002 | 1/2" | 10/120 | 6,38 | (1) |
| 154707002 | 3/4" | 10/60 | 8,81 | (1) |

VALVOLE PER RADIATORI / RADIATOR VALVES

Valvole manuali / Manuale valves
 MERCURY - Attacco PEX/Rame/PEX-AL-PEX / PEX/copper/PEX-AL-PEX

Valvola manuale per radiatori, attacco PEX, multistrato e tubo rame, bocchettone con/senza autotenuta, nichelata
 Manual valve for radiators, PEX, multilayer and copper pipe connection, tail piece with/without auto-seal, nickel-plated
 Handventil für Heizkörper, PEX, Mehrschicht- und Kupferrohr-Anschluss, Rohrverschraubung mit/ohne Selbstdichtung, vernickelt
 Vanne manuelle pour radiateurs, fixation PEX, multicouche et tube en cuivre, raccord avec/sans auto-étanche, nickelée
 Ручной радиаторный клапан, соединения для: PEX, многослойной и медной трубы, патрубок с / без самогерметизации, никелированный

IVR 540 - IVR 540/2



IVR 540

IVR 540/2

- (1) 540/2 - Art. con bocchettone senza autotenuta
- (1) 540/2 - Item with tail piece without auto-seal
- (1) 540/2 - Art. Ventil mit Stutzen ohne Selbstdichtung
- (1) 540/2 - Art. avec raccord non étanche
- (1) 540/2 - Клапан с патрубком без самогерметизации

A squadra con volantino manuale
 Angle valve with manual handle
 Eckförmig mit Handrad
 Equerre avec volant manuel
 Угловой клапан с ручным управлением

| Cod./Code | Misura/Size | Attacco/Connection | □/田 | € |
|-----------|-------------|--------------------|-------|----------|
| 154003180 | 3/8" | 24-19 | 10/60 | 5,89 |
| 154005180 | 1/2" | 24-19 | 10/60 | 6,57 |
| 154003160 | 3/8" | 1/2" | 10/60 | 5,57 |
| 154005160 | 1/2" | 1/2" | 10/60 | 6,41 |
| 154003182 | 3/8" | 24-19 | 10/60 | 5,62 (1) |
| 154005182 | 1/2" | 24-19 | 10/60 | 6,21 (1) |
| 154003162 | 3/8" | 1/2" | 10/60 | 5,30 (1) |
| 154005162 | 1/2" | 1/2" | 10/60 | 6,05 (1) |

IVR 538 - IVR 538/2



IVR 538

IVR 538/2

- (1) 538/2 - Art. con bocchettone senza autotenuta
- (1) 538/2 - Item with tail piece without auto-seal
- (1) 538/2 - Art. Ventil mit Stutzen ohne Selbstdichtung
- (1) 538/2 - Art. avec raccord non étanche
- (1) 538/2 - Клапан с патрубком без самогерметизации

Dritta con volantino manuale
 Straight with manual handle
 Gerade mit Handrad
 Droite avec volant manuel
 Прямой клапан с ручным управлением

| Cod./Code | Misura/Size | Attacco/Connection | □/田 | € |
|-----------|-------------|--------------------|-------|----------|
| 153803180 | 3/8" | 24-19 | 10/60 | 6,11 |
| 153805180 | 1/2" | 24-19 | 10/60 | 8,64 |
| 153803160 | 3/8" | 1/2" | 10/60 | 7,42 |
| 153805160 | 1/2" | 1/2" | 10/60 | 8,12 |
| 153803182 | 3/8" | 24-19 | 10/60 | 5,85 (1) |
| 153805182 | 1/2" | 24-19 | 10/60 | 8,28 (1) |
| 153803162 | 3/8" | 1/2" | 10/60 | 7,15 (1) |
| 153805162 | 1/2" | 1/2" | 10/60 | 7,84 (1) |



VALVOLE PER RADIATORI / RADIATOR VALVES

Valvole manuali / Manuale valves

MERCURY - Detentore attacco PEX/Rame/PEX-AL-PEX / Lockshield PEX/copper/PEX-AL-PEX

Detentore a squadra per radiatori, attacco tubo rame, bocchettone con/senza autotenuta, nichelata
Angle lockshield, copper connection, with/without auto-seal tail piece, nickel plated
Eckförmiges, inspektionierbar, für Heizkörper, Anschluss für Kupferrohr, Stutzen mit/ohne Selbstdichtung, vernickelt
Coude de réglage étanche, fixation à souder pour tube en cuivre, raccord auto-étanche ou non étanche, nickelée
Угловой отсекающий клапан, соединения для стальной трубы, патрубком С / без самогерметизации, никелированный

IVR 541 - IVR 541/2



A squadra
Angle lockshield
Eckförmige Rücklaufverschraubung
Equerre avec volant manuel
Угловой клапан

IVR 541

IVR 541/2

- (1) 541/2 - Art. con bocchettone senza autotenuta
- (1) 541/2 - Item with tail piece without auto-seal
- (1) 541/2 - Art. Ventil mit Stutzen ohne Selbstdichtung
- (1) 541/2 - Art. avec raccord non étanche
- (1) 541/2 - Клапан с патрубком без самогерметизации

| Cod./Code | Misura/Size | Attacco/Connection | □/田 | € | |
|-----------|-------------|--------------------|--------|------|-----|
| 154103180 | 3/8" | 24-19 | 10/120 | 5,12 | |
| 154105180 | 1/2" | 24-19 | 10/120 | 5,78 | |
| 154103160 | 3/8" | 1/2" | 10/120 | 4,77 | |
| 154105160 | 1/2" | 1/2" | 10/120 | 5,60 | |
| 154103182 | 3/8" | 24-19 | 10/120 | 4,85 | (1) |
| 154105182 | 1/2" | 24-19 | 10/120 | 5,42 | (1) |
| 154103162 | 3/8" | 1/2" | 10/120 | 4,51 | (1) |
| 154105162 | 1/2" | 1/2" | 10/120 | 5,24 | (1) |

IVR 539 - IVR 539/2



Dritto
Straight lockshield
Gerade Rücklaufverschraubung
Droit
Прямой клапан

IVR 539

IVR 539/2

- (1) 539/2 - Art. con bocchettone senza autotenuta
- (1) 539/2 - Item with tail piece without auto-seal
- (1) 539/2 - Art. Ventil mit Stutzen ohne Selbstdichtung
- (1) 539/2 - Art. avec raccord non étanche
- (1) 539/2 - Клапан с патрубком без самогерметизации

| Cod./Code | Misura/Size | Attacco/Connection | □/田 | € | |
|-----------|-------------|--------------------|--------|------|-----|
| 153903180 | 3/8" | 24-19 | 10/120 | 5,26 | |
| 153905180 | 1/2" | 24-19 | 10/120 | 7,83 | |
| 153903160 | 3/8" | 1/2" | 10/120 | 6,57 | |
| 153905160 | 1/2" | 1/2" | 10/120 | 7,43 | |
| 153903182 | 3/8" | 24-19 | 10/120 | 5,00 | (1) |
| 153905182 | 1/2" | 24-19 | 10/120 | 7,47 | (1) |
| 153903162 | 3/8" | 1/2" | 10/120 | 6,31 | (1) |
| 153905162 | 1/2" | 1/2" | 10/120 | 7,07 | (1) |

VALVOLE PER RADIATORI / RADIATOR VALVES

Valvole manuali / Manuale valves
MARS

IVR 505 - IVR 505/2

NEW



IVR 505

IVR 505/2



- (1) 505/2 - Art. con bocchettone senza autotenuta
- (1) 505/2 - Item with tail piece without auto-seal
- (1) 505/2 - Art. Ventil mit Stutzen ohne Selbstdichtung
- (1) 505/2 - Art. avec raccord non étanche
- (1) 505/2 - Клапан с патрубком без самогерметизации

Mars, valvola manuale per radiatori, a squadra, attacco tubo ferro, bocchettone con autotenuta, nichelata
Mars, angle manual radiator valve, iron pipe connection, with auto-seal tail piece, nickel plated

Mars, eckförmiges Handventil für Heizkörper, Anschluss für Eisenrohr, Stutzen mit Selbstdichtung - vernickelt Mercury

Mars, robinet manuel équerre pour radiateurs, fixation tube fer, raccord autoétanche - nickelée

Mars, ручной радиаторный клапан, угловой, соединение для стальной трубы, патрубков с самогерметизацией, никелированный

| Cod./Code | Misura/Size | □/田 | € | |
|-----------|-------------|-------|------|-----|
| 150503000 | 3/8" | 10/60 | 6,38 | |
| 150505000 | 1/2" | 10/60 | 6,38 | |
| 150503002 | 3/8" | 10/60 | 6,00 | (1) |
| 150505002 | 1/2" | 10/60 | 6,00 | (1) |

IVR 506 - IVR 506/2

NEW



IVR 506

IVR 506/2



- (1) 506/2 - Art. con bocchettone senza autotenuta
- (1) 506/2 - Item with tail piece without auto-seal
- (1) 506/2 - Art. Ventil mit Stutzen ohne Selbstdichtung
- (1) 506/2 - Art. avec raccord non étanche
- (1) 506/2 - Клапан с патрубком без самогерметизации

Mars, detentore per radiatori, a squadra, attacco tubo ferro, bocchettone con autotenuta, nichelato

Mars, angle lockshield, iron pipe connection, with auto-seal tail piece, nickel plated

Mars, eckförmige Rücklaufverschraubung für Heizkörper, Anschluss für Eisenrohr, Stutzen mit Selbstdichtung, vernickelt

Mars, coude de réglage pour radiateurs, équerre, fixation tube fer, raccord autoétanche, nickelée

Mars, угловой отсекающий клапан для радиаторов, соединения для стальной трубы, патрубков с уплотнения, никелированный

| Cod./Code | Misura/Size | □/田 | € | |
|-----------|-------------|-------|------|-----|
| 150603000 | 3/8" | 1/120 | 5,63 | |
| 150605000 | 1/2" | 1/120 | 5,63 | |
| 150603002 | 3/8" | 1/120 | 5,25 | (1) |
| 150605002 | 1/2" | 1/120 | 5,25 | (1) |

IVR 508 - IVR 508/2

NEW



IVR 508

IVR 508/2



LOTTO MINIMO
MINIMUM BATCH

- (1) 508/2 - Art. con bocchettone senza autotenuta
- (1) 508/2 - Item with tail piece without auto-seal
- (1) 508/2 - Art. Ventil mit Stutzen ohne Selbstdichtung
- (1) 508/2 - Art. avec raccord non étanche
- (1) 508/2 - Клапан с патрубком без самогерметизации

Mars, valvola manuale per radiatori, a squadra, attacco tubo rame, bocchettone con autotenuta, nichelata
Mars, angle manual radiator valve, copper connection, with auto-seal tail piece, nickel plated
Mars, eckförmiges, Handventil für Heizkörper, Anschluss für Kupferrohr, Stutzen mit Selbstdichtung, vernickelt
Mars, robinet manuel pour radiateurs, équerre, fixation tube cuivre, raccord autoétanche - nickelée
Mars, ручной радиаторный клапан, угловой, соединения для медной трубы, патрубком с самогерметизацией, никелированный

| Cod./Code | Misura/Size | Attacco/Connection | □/田 | € | |
|-----------|-------------|--------------------|-------|------|-----|
| 150803160 | 3/8" | 1/2" | 10/60 | 5,36 | |
| 150805160 | 1/2" | 1/2" | 10/60 | 6,11 | |
| 150803162 | 3/8" | 1/2" | 10/60 | 5,10 | (1) |
| 150805162 | 1/2" | 1/2" | 10/60 | 5,74 | (1) |

IVR 510 - IVR 510/2

NEW



IVR 510

IVR 510/2



LOTTO MINIMO
MINIMUM BATCH

- (1) 510/2 - Art. con bocchettone senza autotenuta
- (1) 510/2 - Item with tail piece without auto-seal
- (1) 510/2 - Art. Ventil mit Stutzen ohne Selbstdichtung
- (1) 510/2 - Art. avec raccord non étanche
- (1) 510/2 - Клапан с патрубком без самогерметизации

Mars, detentore per radiatori, a squadra, attacco tubo rame, bocchettone con autotenuta, nichelato
Mars, angle lockshield, copper connection, with auto-seal tail piece, nickel plated
Mars, eckförmige Rücklaufverschraubung für Heizkörper, Anschluss für Kupferrohr, Stutzen mit Selbstdichtung, vernickelt
Mars, coude de réglage pour radiateurs, équerre, fixation tube cuivre, raccord autoétanche ou non étanche, nickelée
Mars, угловой отсекающий клапан, соединения для медной трубы, патрубком с самогерметизацией, никелированный

| Cod./Code | Misura/Size | Attacco/Connection | □/田 | € | |
|-----------|-------------|--------------------|-------|------|-----|
| 151003160 | 3/8" | 1/2" | 1/120 | 4,73 | |
| 151005160 | 1/2" | 1/2" | 1/120 | 5,44 | |
| 151003162 | 3/8" | 1/2" | 1/120 | 4,50 | (1) |
| 151005162 | 1/2" | 1/2" | 1/120 | 5,06 | (1) |

VALVOLE MANUALI / MANUAL VALVES

Componenti e ricambi / Components and spare parts

IVR 324



Bocchettone per Saturn e Mercury - Con autotenuta
Tail piece for Saturn e Mercury - with auto-seal
Rohrverschraubung für Saturn und Mercury - mit Selbstdichtung
Raccord pour Saturn et Mercury - avec autoétanche
Самогерметизирующий патрубок для моделей Saturn и Mercury

| Cod./Code | Misura/Size | □/田 | € |
|-----------|-------------|--------|------|
| 132403051 | 3/8" x 1/2" | 20/240 | 2,08 |
| 132405071 | 1/2" x 3/4" | 20/240 | 2,66 |
| 132407101 | 3/4" x 1" | 10/120 | 4,25 |

IVR 326



Bocchettone per Saturn e Mercury senza autotenuta - (codolo + calotta)
Tail piece for Saturn e Mercury with auto-seal (tail piece and nut)
Rohrverschraubung für Saturn und Mercury mit Selbstdichtung (Verschraubung und Nuss)
Raccord pour Saturn et Mercury avec autoétanche (queue et calotte)
Патрубок без самогерметизации для моделей Saturn и Mercury (хвостовая часть с гайкой)

| Cod./Code | Misura/Size | □/田 | € |
|-----------|-------------|--------|------|
| 132603051 | 3/8" x 1/2" | 20/240 | 2,01 |
| 132605071 | 1/2" x 3/4" | 20/240 | 2,46 |
| 132607101 | 3/4" x 1" | 10/120 | 3,47 |
| 132610121 | 1" x 1"1/4 | 10/160 | 5,70 |

IVR 325



Bocchettone telescopico, nichelato
Telescopic tail piece, nickel-plated
Anschluss-Stutzen teleskopisch - vernickelt
Raccord télescopique - nickelé
Телескопическое соединение, никелированное

| Cod./Code | Misura/Size | □/田 | € |
|-----------|-------------|--------|------|
| 132503051 | 3/8" | 20/400 | 2,20 |
| 132505071 | 1/2" | 10/200 | 3,13 |
| 132507101 | 3/4" | 5/100 | 5,54 |

IVR 590



Volantino manuale ABS colore RAL 9010 - per MERCURY, AVANT FLOOR
ABS manual handle Ral 9010 colour - for MERCURY, AVANT FLOOR
ABS Handrad, RAL9010 - für MERCURY, AVANT FLOOR
Volant manuel ABS couleur RAL 9010 - pour MERCURY, AVANT FLOOR -
Колпачок для ручной регулировки, ABS цвет Ral 9010 - для MERCURY, AVANT FLOOR

| Cod./Code | Misura/Size | □/田 | € |
|-----------|-------------|--------|------|
| 159000002 | 3/8" - 1/2" | 10/180 | 0,67 |

IVR 586



Cappuccio per detentori - Per detentori MERCURY - MERCURY PLUS - Ottone nichelato
Plug for MERCURY lockshield - MERCURY PLUS - nickel-plated brass
Kappe für Rücklaufverschraubungen MERCURY - MERCURY PLUS - aus vernickeltem Messing
Capuchon pour coude de réglage MERCURY - MERCURY PLUS - en laiton nickelé
Заглушка для отсекающего клапана MERCURY - MERCURY PLUS из латуни, никелированная

| Cod./Code | Misura/Size | □/田 | € |
|-----------|--------------------|--------|------|
| 158600001 | 3/8" - 1/2" - 3/4" | 10/240 | 0,62 |

IVR 587



Cappuccio per detentori - Per detentori MERCURY - ABS colore Ral 9010
Plug for Lockshield - For lockshields MERCURY - ABS color Ral 9010
Kappe für Rücklaufverschraubung MERCURY - ABS Farbe Ral 9010
Capuchon pour coudes de réglage MERCURY - ABS couleur RAL 9010
Крышка для отсекающего клапана MERCURY - ABS, цвет Ral 9010

| Cod./Code | Misura/Size | □/田 | € |
|-----------|-------------|--------|------|
| 158700001 | 3/8" - 1/2" | 10/240 | 0,30 |

IVR 435



Kit valvole manuali a squadra per tubo rame, PEX e multistrato, composto da: valvola e detentore MERCURY, 2+2 DX/SX riduzioni con guarnizione siliconica, valvola scarico aria, tappo ottone con cappuccio bianco

Manual angle radiator valve kit for copper, PEX and multilayer pipe, includes: MERCURY radiator valve and lockshield, 2+2 DX/SX reductions with silicone gasket, manual air vent valve, brass plug with white plastic cap

KIT (Garnitur) manuelles Heizkörperventile, eckförmig für Kupfer-, PEX - und Mehrschichtrohr, bestehend aus: Ventil und Rücklaufverschraubung MERCURY, 2+2 rechts/links, Reduzierstücke mit Silikondichtung, Luftablassventil, Messingdeckel mit weißer Kappe

Kit vannes manuelles équerre pour tube en cuivre, PEX et multicouche, composé de: vanne et coude de réglage MERCURY, 2+2 DX/SX réductions avec joint silicone, vanne d'évacuation de l'air, bouchon en laiton avec capuchon blanc

Комплект ручных угловых клапанов для медной, многослойной и трубы PEX включает: радиаторный клапан и отсекающий клапан Mercury, 2 + 2 пр./лев. футорки с силиконовыми прокладками, ручной воздухоотводчик, заглушки из латуни с белыми пластиковыми колпачками.

| Cod./Code | Misura/Size | Attacco/Connection | □/田 | € |
|-----------|-------------|--------------------|-----|-------|
| 143503682 | 3/8" | 24-19 | 1/7 | 20,38 |
| 143505682 | 1/2" | 24-19 | 1/7 | 21,85 |

IVR 437



Kit universale per radiatori alluminio 1" flangia Ø 42 RAL 9010 composto da: n° 2 DX + n° 2 SX riduzioni con guarnizione siliconica, valvola scarico aria, tappo ottone con cappuccio bianco

Universal kit for aluminum radiators 1" series, Ø 42 flange RAL 9010 includes: n° 2 DX + n° 2 SX reductions with silicone gasket, manual air vent valve, brass plug with white plastic cap

Universalgarnitur für Aluheizkörper, 1" Flansch, Ø 42 RAL 9010, bestehend aus: 2 rechten + 2 linken Reduzierstücke mit Silikondichtung, Entlüftungsventil, Messingdeckel mit weißer Kappe

Kit universel pour radiateurs aluminium 1" bride Ø 42 RAL 9010 composé de: n° 2 DX + n° 2 SX réductions avec joint silicone, vanne d'évacuation de l'air, bouchon en laiton avec capuchon blanc

Универсальный набор для алюминиевых радиаторов 1", фланец Ø 42, RAL 9010 состоящий из: 2+2 пр./лев. футорки с силиконовыми прокладками, воздухоотводчиком, заглушка из латуни с белым пластиковым колпачком

| Cod./Code | Misura/Size | Attacco/Connection | □/田 | € |
|-----------|-------------|--------------------|-----|------|
| 143710673 | 1" | 3/8" | 1/5 | 6,85 |
| 143710675 | 1" | 1/2" | 1/5 | 6,85 |

IVR 438



Kit universale per radiatori alluminio 1" flangia Ø 42 RAL 9010 composto da: n° 2 DX + n° 2 SX riduzioni con guarnizione siliconica, valvola scarico aria, tappo ottone con cappuccio bianco

Universal kit for aluminum radiators 1" series, Ø 42 flange RAL 9010 includes: n° 2 DX + n° 2 SX reductions with silicone gasket, manual air vent valve, brass plug with white plastic cap

Universalgarnitur für Aluheizkörper, 1" Flansch, Ø 42 RAL 9010, bestehend aus: 2 rechten + 2 linken Reduzierstücke mit Silikondichtung, Entlüftungsventil, Messingdeckel mit weißer Kappe

Kit universel pour radiateurs en aluminium 1" bride Ø 42 RAL 9010 composé de: n° 2 DX + n° 2 SX réductions avec joint de silicone, vanne d'évacuation de l'air, bouchon en laiton avec chapeau blanc, couple de supports

Универсальный набор для алюминиевых радиаторов 1", фланец Ø 42, RAL 9010 состоящий из : 2+2 пр./лев. футорки с силиконовыми прокладками, ручной воздухоотводчик, заглушки из латуни с белыми пластиковыми колпачками

| Cod./Code | Misura/Size | Attacco/Connection | □/田 | € |
|-----------|-------------|--------------------|-----|------|
| 143810673 | 1" | 3/8" | 1/5 | 7,37 |
| 143810675 | 1" | 1/2" | 1/5 | 8,38 |



VALVOLE PER RADIATORI / RADIATOR VALVES

Valvole H / H valves

IVR 753



Valvola "H" con attacco M per impianti bitubo con derivazioni a parete
 "H" valve with male connection for double pipe systems with wall pipes
 Zweirohr-Hahnblock Eckform mit AG-Anschluß
 Pièce "H" avec embout mâle pour systèmes bitube avec dérivation murales
 Клапан "H" с наружной резьбой, для двухтрубных систем, с возможностью монтажа в стену

| Cod./Code | Misura/Size | □/田 | € |
|-----------|-------------|------|-------|
| 175307001 | 3/4" | 6/48 | 15,53 |

IVR 754



Valvola "H" con attacco M per impianti monotubo/bitubo (con bypass regolabile 50-100%) con derivazioni a parete
 "H" valve with male connection for single/double pipe systems (with adjustable bypass 50-100%) with wall pipes
 Ein-/Zweirohr-Hahnblock (mit regelbarer Bypass 50-100%) Eckform mit AG Anschluß
 Pièce "H" avec embout mâle pour systèmes monotube/bitube (avec bypass réglable 50-100%) avec dérivation murales
 Клапан "H" с наружной резьбой для одно/двухтрубных систем (с регулируемым бай-пассом 50-100%) с возможностью монтажа в стену

| Cod./Code | Misura/Size | □/田 | € |
|-----------|-------------|------|-------|
| 175407001 | 3/4" | 6/48 | 19,39 |

IVR 755



Valvola "H" con attacco M per impianti bitubo con derivazioni a pavimento
 "H" valve with male connection for double pipe systems with floor pipes
 Zweirohr-Hahnblock Durchgangsform mit AG Anschluß
 Pièce "H" avec embout mâle pour systèmes bitube avec dérivation au sol
 Клапан "H" с наружной резьбой, для двухтрубных систем, с возможностью монтажа в пол

| Cod./Code | Misura/Size | □/田 | € |
|-----------|-------------|------|-------|
| 175507001 | 3/4" | 6/48 | 15,60 |

IVR 756



Valvola "H" con attacco "M" per impianti monotubo/bitubo (con bypass regolabile 50-100%) con derivazioni a pavimento

"H" valve with male connection for single/double pipe systems (with adjustable bypass 50-100%) with floor pipes

Ein-/Zweirohr-Hahnblock (mit regelbarer Bypass 50-100%) Durchgangsform mit AG Anschluss

Pièce "H" avec embout mâle pour systèmes monotube/bitube (avec bypass réglable 50-100%) avec dérivations au sol

Клапан "H" с наружной резьбой, для одно/двухтрубных систем (с регулируемым бай-пассом 50-100%), с возможностью монтажа в пол

| Cod./Code | Misura/Size | □/田 | € |
|-----------|-------------|------|-------|
| 175607001 | 3/4" | 6/48 | 18,75 |

IVR 758



Adattatore per valvole "H"

Adapter for "H" valves

Adapter für "H"-Ventile

Adaptateur pour pièces "H"

Адаптер для "H"клапанов

| Cod./Code | Misura/Size | □/田 | € |
|-----------|-------------|---------|------|
| 175807051 | 3/4"x1/2" | 100/800 | 1,62 |



VALVOLE FAN-COIL / FAN-COIL VALVES

IVR 748

NEW



Valvola fan-coil a 2 vie - attacchi M/M
Fan-coil 2-way valve - M/M
2-Wege Kugelhan für Gebläsekonvektoren - AG/AG
Vanne à 2 voies pour ventilo-convecteurs - M/M
2-ходовой клапан для фанкойлов ,соединения Н/Н

| Cod./Code | Misura/Size | □/田 | € |
|-----------|-------------|-----|-------|
| 174805001 | 1/2" | 1 | 11,59 |
| 174807001 | 3/4" | 1 | 11,70 |
| 174810001 | 1" | 1 | 16,73 |

IVR 749

NEW



Valvola fan-coil a 3 vie - attacchi M/M
Fan-coil 3-way valve - M/M
3-Wege Kugelhan für Gebläsekonvektoren - AG/AG
Vanne à 3 voies pour ventilo-convecteurs - M/M
3-ходовой клапан для фанкойлов ,соединения Н/Н

| Cod./Code | Misura/Size | □/田 | € |
|-----------|-------------|-----|-------|
| 174905001 | 1/2" | 1 | 14,96 |
| 174907001 | 3/4" | 1 | 15,79 |
| 174910001 | 1" | 1 | 21,11 |

IVR 750

NEW



Valvola fan-coil a 4 vie - attacchi M/M
Fan-coil 4-way valve - M/M
4-Wege Kugelhan für Gebläsekonvektoren - AG/AG
Vanne à 4 voies pour ventilo-convecteurs - M/M
4-ходовой клапан для фанкойлов ,соединения Н/Н

| Cod./Code | Misura/Size | □/田 | € |
|-----------|-------------|-----|-------|
| 175005001 | 1/2" | 1 | 18,71 |
| 175007001 | 3/4" | 1 | 17,96 |
| 175010001 | 1" | 1 | 27,23 |

COMPONENT / COMPONENTS

Adattatori / Adapters

IVR 580



Adattatori preassemblati per tubo rame - Nichelato
Adapters preassembled for copper pipe - Nickel plated
Eingebaute Zwischenstücke für Kupferrohr - Vernickelt
Adaptateurs préassemblés pour tubes en cuivre - Niklé
Адаптеры в сборе для медной трубы - Никелированные

| Cod./Code | Misura/Size | Attacco/Connection | □/田 | € |
|-----------|-------------|--------------------|--------|------|
| 158005100 | 10 | 1/2" | 20/200 | 3,00 |
| 158005120 | 12 | 1/2" | 20/400 | 1,88 |
| 158005140 | 14 | 1/2" | 20/200 | 2,21 |
| 158005150 | 15 | 1/2" | 20/400 | 1,95 |
| 158005160 | 16 | 1/2" | 20/400 | 2,21 |
| 158024100 | 10 | 24-19 | 20/400 | 2,74 |
| 158024120 | 12 | 24-19 | 20/400 | 2,10 |
| 158024140 | 14 | 24-19 | 20/400 | 2,60 |
| 158024150 | 15 | 24-19 | 20/400 | 2,14 |
| 158024160 | 16 | 24-19 | 20/400 | 2,14 |
| 158024180 | 18 | 24-19 | 20/400 | 2,21 |
| 158007120 | 12 | 3/4" EK | 20/400 | 2,66 |
| 158007140 | 14 | 3/4" EK | 20/400 | 2,63 |
| 158007150 | 15 | 3/4" EK | 20/400 | 3,23 |
| 158007160 | 16 | 3/4" EK | 20/400 | 2,25 |
| 158007180 | 18 | 3/4" EK | 20/400 | 2,36 |

IVR 581



Adattatori universali a compressione per tubi multistrato e polietilene reticolato PEX, nichelati
Adapters for multilayer pipe and cross-linked polyethylene pipe PEX, nickel plated
Universal-Zwischenstücke/Adapter zur Kompressions für Mehrschichtrohre und Rohre aus vernetztem und vernickelt Polyethylen PEX - vernickelt

Adaptateurs universels à compression pour tubes multicouche et polyéthylène réticulé PEX - nickelés - nichelés

Никелированные универсальные компрессионные адаптеры для металлопластиковых труб, труб из сшитого полиэтилена PEX, никелированных труб

| Cod./Code | Misura/Size | Attacco/Connection | □/田 | € |
|-----------|-------------|--------------------|--------|------|
| 158105143 | 14 x 2 | 1/2" | 20/400 | 2,06 |
| 158105156 | 15 x 2,5 | 1/2" | 20/400 | 2,06 |
| 158105163 | 16 x 2 | 1/2" | 20/400 | 2,21 |
| 158105164 | 16 x 2,25 | 1/2" | 20/400 | 2,59 |
| 158124143 | 14 x 2 | 24-19 | 20/400 | 3,56 |
| 158124156 | 15 x 2,5 | 24-19 | 20/400 | 2,35 |
| 158124163 | 16 x 2 | 24-19 | 20/400 | 2,35 |
| 158124164 | 16 x 2,25 | 24-19 | 20/400 | 2,35 |
| 158124173 | 17 x 2 | 24-19 | 20/400 | 3,00 |
| 158124183 | 18 x 2 | 24-19 | 20/400 | 2,85 |
| 158124203 | 20 x 2 | 24-19 | 20/400 | 3,68 |
| 158107143 | 14 x 2 | 3/4" EK | 20/400 | 2,35 |
| 158107163 | 16 x 2 | 3/4" EK | 20/300 | 2,26 |
| 158107173 | 17 x 2 | 3/4" EK | 20/300 | 4,01 |
| 158107183 | 18 x 2 | 3/4" EK | 20/300 | 4,65 |
| 158107203 | 20 x 2 | 3/4" EK | 20/300 | 3,60 |
| 158110203 | 20 x 2 | 1" | 10/150 | 3,28 |
| 158110255 | 25 x 2,3 | 1" | 10/150 | 4,14 |
| 158110256 | 25 x 2,5 | 1" | 10/150 | 4,05 |
| 158110268 | 26 x 3 | 1" | 10/80 | 4,05 |

COMPONENTI / COMPONENTS
Centrale termica / Thermal central



IVR 334



Gruppo di alimentazione serie pesante per impianti di riscaldamento a circuito chiuso con riduttore di pressione, attacco manometro da 1/4", filtro e rubinetto di intercettazione. Entrata F, uscita M a bocchettone

Automatic filling unit with pressure reducer, 1/4" manometer connection, filter and shut off valve, with inlet F thread and M union connection

Versorgungsgruppe für Heizungssystemen mit geschlossenem Kreislauf mit Druckminderer - schwere Ausführung, Manometeranschluß 1/4", Filter und Absperrventil. Eingang IG und Ausgang AG mit Anschluss-Stutzen (Verschraubung)

Groupe d'alimentation série lourde pour implémentation de chauffage à circuit fermé avec reducteur de pression, fixations manomètre de 1/4", filtre et robinet d'interception. Entrée F sortie M à raccord

Группа подпитки, усиленная версия для закрытых систем отопления, включает редуктор давления, соединение под манометр 1/4", фильтр и перекрывающий клапан. Соединения: В со стороны входа и сгон с накидной гайкой со стороны выхода

| Cod./Code | Misura/Size | □/田 | € |
|-----------|-------------|------|-------|
| 133405001 | 1/2" | 1/15 | 33,54 |

IVR 336



Gruppo di alimentazione serie leggera per impianti di riscaldamento a circuito chiuso con riduttore di pressione, attacco manometro da 1/4", filtro e rubinetto di intercettazione. Entrata M a bocchettone, uscita F

Automatic filling unit with pressure reducer, 1/4" manometer connection, filter and shut off valve, with inlet M union connection and F thread

Versorgungsgruppe für Heizungssysteme mit geschlossenem Kreislauf mit Druckminderer - leichte Ausführung, Manometeranschluß 1/4", Filter und Absperrventil. Eingang (IG) und Ausgang (AG) mit Anschluss-Stutzen (Verschraubung)

Groupe d'alimentation série légère pour implémentation de chauffage à circuit fermé avec reducteur de pression, Fixations manomètre de 1/4", filtre et robinet d'interception. Entrée M raccord, sortie F

Группа подпитки, облегченная версия, для закрытых систем отопления, включает редуктор давления, соединение под манометр 1/4", фильтр и перекрывающий клапан. Соединения: патрубок с накидной гайкой со стороны входа и В со стороны выхода

| Cod./Code | Misura/Size | □/田 | € |
|-----------|-------------|------|-------|
| 133605001 | 1/2" | 1/25 | 25,80 |

IVR 358



Manometro diametro 50 - 63 mm - attacco radiale Per IVR 334 - 336

Radial pressure gauge circle 50 - 63 mm. For IVR 334 - 336

Manometer Ø 50 - 63 mm - Anschluss unten, für IVR 304

Manometre Ø 50 - 63mm - fixation radiale pour ivr 304

Радиальный манометр 50-63 мм. Для IVR 334 - 336

| Cod./Code | Misura/Size | □/田 | € |
|-----------|----------------------------------|-------|------|
| 135802116 | 1/4" Ø 50 - scala/scale 0-16 bar | 1/100 | 7,28 |
| 135802206 | 1/4" Ø 63 - scala/scale 0-6 bar | 1/100 | 8,25 |
| 135802210 | 1/4" Ø 63 - scala/scale 0-10 bar | 1/100 | 8,25 |
| 135802216 | 1/4" Ø 63 - scala/scale 0-16 bar | 1/100 | 8,25 |

COMPONENTI / COMPONENTS

Valvole di bilanciamento / Balancing valves

IVR 340



Valvola in ottone DZR ad orifizio fisso, filettata F/F (ISO 228/1 per DN15/20, ISO7/1 Rp oltre). Brugola di presettaggio in dotazione. Condizioni di esercizio: da -10° C a +130° C

Fixed orifice DZR brass double reg. valve, threaded F/F (ISO 228/1 for DN15/20, ISO7/1 Rp above). Valve supplied with allen key for setting. Working conditions: -10°C to +130° C

Ventil aus DZR-Messing mit fester Öffnung, alle Anschlüsse mit Innengewinde (ISO 228/1 für DN15/20, ISO7/1 Rp höher). Ausstattung mit Inbusschlüssel zur Voreinstellung. Betriebstemperatur von -10° C zu + 130° C

Vanne d'équilibrage statique en laiton DZR, orifice fixe, fileté F/F (ISO 228/1 pour DN15 / 20, ISO7 / Rp 1 au-dessus). Valve fourni avec une clé Allen pour le réglage. Conditions de travail: -10° C à + 130° C

Балансировочный клапан из латуни марки DZR, фиксированное отверстие, резьбовое соединение В/В (ISO 228/1 для DN15/20, ISO7/1). Клапан поставляется с ключом для регулировки. Рабочая температура от -10° C до +130° C

| Cod./Code | Misura/Size | □/田 | € |
|-----------|-------------|------|--------|
| 134005001 | 1/2" | 4/16 | 58,10 |
| 134007001 | 3/4" | 5/20 | 62,29 |
| 134010001 | 1" | 4/16 | 65,22 |
| 134012001 | 1"1/4 | 4/16 | 99,50 |
| 134015001 | 1"1/2 | 2/8 | 120,75 |
| 134020001 | 2" | 2/8 | 175,75 |

IVR 342



Valvola in ghisa a doppia reg. con prese di pressione in DZR (non montate), ad orifizio variabile, flangiata PN16 (EN1092-2). Condizioni di esercizio: da -10° C a +120° C

Cast iron double setting valve with test points in DZR brass (unmounted), variable orifice, Flangiata PN16 (EN1092-2). Working conditions: -10° C to +120° C

Ventil aus Gusseisen - Doppelseinstellung mit DZR Drucksteckdose (nicht eingebaut), mit veränderbarer Öffnung, Flansch PN16 (EN 1092-2). Betriebstemperatur: -10° C to +120° C

Vanne d'équilibrage statique en fonte, avec prises de pression pas montée, orifice variable, pourvue de brides PN16 (EN1092-2). Conditions de travail: -10° C à + 120° C

Чугунный клапан с двойной регулировкой, вставки для контроля из латуни DZR (не установлены), фланцы PN16 (EN1092-2). Рабочая температура: от -10° C до +120° C

| Cod./Code | Misura/Size | □/田 | € |
|-----------|-------------|-----|---------|
| 134225001 | dn 65 | 1 | 429,00 |
| 134230001 | dn 80 | 1 | 622,88 |
| 134240001 | dn 100 | 1 | 853,88 |
| 134250001 | dn 125 | 1 | 1175,63 |
| 134260001 | dn 150 | 1 | 1460,25 |
| 134280001 | dn 200 | 1 | 2582,25 |
| 134290001 | dn 250 | 1 | 3778,50 |
| 134295001 | dn 300 | 1 | 6971,25 |

IVR 341

NEW



Valvola in bronzo ad orifizio variabile, filettata F/F ISO 228/1, brugola di presettaggio in dotazione. Condizioni di esercizio da -10° a +130°

Bronze valve with variable orifice, F/F ISO 228/1 threaded unions, supplied with Allen key for setting. Working temperatures: -10 +130°

Ausgleichventil aus Rotguss mit veränderbarer Öffnung, IG/IG Gewinde ISO 228/1, geliefert mit dem Inbusschlüssel zur Voreinstellung. Betriebstemperaturen: -10° +130°

Vanne en bronze avec orifice variable, filetage F/F ISO 228/1, fournie avec la clé Allen pour le réglage. Températures de fonctionnement: -10° +130°

Бронзовый клапан с вариационным отверстием, резьбовое соединение В/В ISO 228/1, поставляется с установочным ключом. Условия эксплуатации от -10 ° до + 130 °

| Cod./Code | Misura/Size | □/田 | € |
|-----------|-------------|------|--------|
| 134105001 | 1/2" | 4/16 | 56,53 |
| 134107001 | 3/4" | 5/20 | 59,88 |
| 134110001 | 1" | 4/16 | 64,33 |
| 134112001 | 1"1/4 | 4/16 | 93,93 |
| 134115001 | 1"1/2 | 2/8 | 115,46 |
| 134120001 | 2" | 2/8 | 153,74 |

IVR 344

NEW



Valvola di bilanciamento automatico in ottone DZR con bocchettoni filettata F/F ISO 7/1 RP condizioni di esercizio da -10° a +130°

Automatic balancing valve in DZR brass with tail piece F/F ISO 7/1 RP thread working temperatures -10° +130°

Automatisches Ausgleichsventil aus DZR-Messing mit Rohrverschraubungen Gewinde IG/IG ISO 7/1 RP Betriebstemperaturen -10° +130°

Vanne d'équilibrage en laiton DZR avec raccord de tuyauterie température de fonctionnement -10° +130°

Автоматический балансировочный клапан из латуни DZR, со сгоном ,резьбовые соединения В/В ISO 7/1 RP . Условия эксплуатации от -10 ° до + 130 °

| Cod./Code | Misura/Size | □/田 | € |
|-----------|-------------|------|--------|
| 134405001 | 1/2" | 4/16 | 57,17 |
| 134407001 | 3/4" | 5/20 | 62,94 |
| 134410001 | 1" | 4/16 | 70,13 |
| 134412001 | 1"1/4 | 4/16 | 139,44 |
| 134415001 | 1"1/2 | 2/8 | 147,98 |
| 134420001 | 2" | 2/8 | 172,70 |

IVR 344/C

NEW



Cartuccia stabilizzatrice di portata per valvola di bilanciamento automatico

Cartridge for the stabilisation of water flow for automatic balancing

Kartusche zur Stabilisierung des Wasserflusses für automatischen Ausgleich

Cartouche de stabilisation du débit pour la vanne d'équilibrage automatique

Картридж стабилизации потока для автоматического балансировочного клапана

DN15 - DN20 - DN25

| Cod./Code | Range ΔP | l/h | □/田 | € |
|-----------|--------------|------|-----|-------|
| 134452001 | 17 - 240 kPa | 468 | 1 | 54,26 |
| 134452002 | 17 - 240 kPa | 540 | 1 | 54,26 |
| 134452003 | 17 - 240 kPa | 612 | 1 | 54,26 |
| 134452004 | 17 - 240 kPa | 684 | 1 | 54,26 |
| 134452011 | 18 - 240 kPa | 756 | 1 | 54,26 |
| 134452012 | 18 - 240 kPa | 864 | 1 | 54,26 |
| 134452013 | 18 - 240 kPa | 972 | 1 | 54,26 |
| 134452014 | 18 - 240 kPa | 1080 | 1 | 54,26 |
| 134452015 | 18 - 240 kPa | 1188 | 1 | 54,26 |
| 134452016 | 18 - 240 kPa | 1296 | 1 | 54,26 |
| 134452017 | 18 - 240 kPa | 1440 | 1 | 54,26 |
| 134452021 | 19 - 240 kPa | 1620 | 1 | 54,26 |
| 134452022 | 19 - 240 kPa | 1800 | 1 | 54,26 |
| 134452031 | 21 - 240 kPa | 1980 | 1 | 54,26 |
| 134452041 | 22 - 240 kPa | 2160 | 1 | 54,26 |
| 134452051 | 24 - 240 kPa | 2376 | 1 | 54,26 |
| 134452052 | 24 - 240 kPa | 2592 | 1 | 54,26 |

DN32 - DN40 - DN50

| Cod./Code | Range ΔP | l/h | □/田 | € |
|-----------|--------------|------|-----|-------|
| 134453001 | 13 - 230 kPa | 1116 | 1 | 91,54 |
| 134453002 | 13 - 230 kPa | 1224 | 1 | 91,54 |
| 134453003 | 13 - 230 kPa | 1332 | 1 | 91,54 |
| 134453011 | 14 - 230 kPa | 1440 | 1 | 91,54 |
| 134453012 | 14 - 230 kPa | 1656 | 1 | 91,54 |
| 134453013 | 14 - 230 kPa | 1800 | 1 | 91,54 |
| 134453014 | 14 - 230 kPa | 1980 | 1 | 91,54 |
| 134453015 | 14 - 230 kPa | 2088 | 1 | 91,54 |
| 134453016 | 14 - 230 kPa | 2232 | 1 | 91,54 |
| 134453021 | 15 - 230 kPa | 2412 | 1 | 91,54 |
| 134453022 | 15 - 230 kPa | 2664 | 1 | 91,54 |
| 134453023 | 15 - 230 kPa | 2988 | 1 | 91,54 |
| 134453024 | 15 - 230 kPa | 3240 | 1 | 91,54 |
| 134453025 | 15 - 230 kPa | 3492 | 1 | 91,54 |
| 134453026 | 15 - 230 kPa | 3780 | 1 | 91,54 |
| 134453027 | 15 - 230 kPa | 4320 | 1 | 91,54 |
| 134453031 | 16 - 230 kPa | 4680 | 1 | 91,54 |
| 134453041 | 17 - 230 kPa | 5184 | 1 | 91,54 |
| 134453042 | 17 - 230 kPa | 5616 | 1 | 91,54 |
| 134453051 | 18 - 230 kPa | 6048 | 1 | 91,54 |
| 134453061 | 19 - 230 kPa | 6480 | 1 | 91,54 |
| 134453062 | 19 - 230 kPa | 7056 | 1 | 91,54 |

IVR 346



Prese di pressione, filettata M 1/4" ISO 7/1 R in ottone DZR
 Pressure test point, M 1/4" ISO 7/1 R in DZR brass
 Drucksteckdose, Außengewinde 1/4" ISO 7/1 R aus DZR-Messing
 Prises de pression, fileté M 1/4" ISO 7/1 R en laiton DZR
 Точка контроля давления, соединения H 1/4" ISO 7/1 R, латунь марки DZR

| Cod./Code | Misura/Size | □/田 | € |
|-----------|-----------------------------------|------|-------|
| 134610201 | 1/4" presa press cravatta blu | 5/90 | 7,43 |
| 134610202 | 1/4" presa press cravatta ros | 5/90 | 7,43 |
| 134630201 | 1/4" kit pr press c/prol crav blu | 5/90 | 23,93 |
| 134630202 | 1/4" kit pr press c/prol crav ros | 5/90 | 23,93 |

COMPONENTI / COMPONENTS

Gruppi valvole di Sicurezza e scarico caldaia / Safety Valves

IVR 718



Gruppo di sicurezza caldaia in ottone; valvola di intercettazione; manometro; scarico aria automatico; valvola di sicurezza

Brass safety set; automatic shut-off valve; pressure gauge; automatic air-vent; safety valve

Sicherheitsgruppe für Heizkessel aus Messing; Abfang / Absperrventil; Manometer; automatisches Entlüftung; Sicherheitsventil

Groupe de sécurité chaudière en laiton, vanne d'interception, manometre; sortie aire automatique; vanne de sécurité

Группа безопасности котла латунная, отсекающий кран, манометр, автоматический воздухоотводчик, предохранительный клапан

| Cod./Code | Misura/Size | □/田 | € |
|-----------|--------------|-----|-------|
| 171810020 | 1" - 2,0 bar | 1/7 | 52,57 |
| 171810025 | 1" - 2,5 bar | 1/7 | 52,57 |
| 171810030 | 1" - 3,0 bar | 1/7 | 52,57 |
| 171810040 | 1" - 4,0 bar | 1/7 | 52,57 |
| 171810050 | 1" - 5,0 bar | 1/7 | 52,57 |

IVR 718/C



Guscio di coibentazione per GRUPPO SAFETY IVR 718

Isolating element for SAFETY SET IVR 718

Isolierhülse für SAFETY SET IVR 718

Coque isolante pour GROUPE SAFETY IVR 718

Изолирующий элемент для ГРУППЫ БЕЗОПАСНОСТИ IVR 718

| Cod./Code | Misura/Size | □/田 | € |
|-----------|------------------|-----|-------|
| 335800421 | Guscio / Coibent | 1/5 | 18,11 |

IVR 355



Valvola di sicurezza M/F
Safety valve M/F
Sicherheitsventile AG/IG
Soupape de sécurité M/F
Предохранительный клапан H/B

| Cod./Code | Misura/Size | □/田 | € |
|-----------|--------------|--------|------|
| 135505151 | 1/2" 1.5 Bar | 10/150 | 5,11 |
| 135505201 | 1/2" 2 Bar | 10/150 | 5,11 |
| 135505251 | 1/2" 2.5 Bar | 10/150 | 5,11 |
| 135505301 | 1/2" 3 Bar | 10/150 | 5,11 |
| 135505401 | 1/2" 4 Bar | 10/150 | 5,11 |
| 135505501 | 1/2" 5 Bar | 10/150 | 5,11 |
| 135505601 | 1/2" 6 Bar | 10/150 | 5,11 |

IVR 356



Valvola di sicurezza M/F - con attacco manometro 1/4"
Safety valve M/F - with manometer connection 1/4"
Sicherheitsventile AG/IG - mit manometeranschluss 1/4"
Soupape de sécurité M/F - avec fixations pour le manomètre 1/4
Предохранительный клапан В/Н - с соединением для манометра 1/4"

| Cod./Code | Misura/Size | □/田 | € |
|-----------|--------------|--------|------|
| 135605151 | 1/2" 1.5 Bar | 10/100 | 6,74 |
| 135605201 | 1/2" 2 Bar | 10/100 | 6,74 |
| 135605251 | 1/2" 2.5 Bar | 10/100 | 6,74 |
| 135605301 | 1/2" 3 Bar | 10/100 | 6,74 |
| 135605401 | 1/2" 4 Bar | 10/100 | 6,74 |
| 135605501 | 1/2" 5 Bar | 10/100 | 6,74 |
| 135605601 | 1/2" 6 Bar | 10/100 | 6,74 |

IVR 350



Valvola di sicurezza F/F
Safety valve F/F
Sicherheitsventile IG/IG
Soupape de sécurité F/F
Предохранительный клапан В/В

| Cod./Code | Misura/Size | □/田 | € |
|-----------|--------------|--------|-------|
| 135005151 | 1/2" 1.5 Bar | 10/150 | 5,11 |
| 135005201 | 1/2" 2 Bar | 10/150 | 5,11 |
| 135005251 | 1/2" 2.5 Bar | 10/150 | 5,11 |
| 135005301 | 1/2" 3 Bar | 10/150 | 5,11 |
| 135005401 | 1/2" 4 Bar | 10/150 | 5,11 |
| 135005501 | 1/2" 5 Bar | 10/150 | 5,11 |
| 135005601 | 1/2" 6 Bar | 10/150 | 5,11 |
| 135007151 | 3/4" 1.5 Bar | 10/140 | 8,02 |
| 135007201 | 3/4" 2 Bar | 10/140 | 8,02 |
| 135007251 | 3/4" 2.5 Bar | 10/140 | 8,02 |
| 135007301 | 3/4" 3 Bar | 10/140 | 8,02 |
| 135007401 | 3/4" 4 Bar | 10/140 | 8,02 |
| 135007501 | 3/4" 5 Bar | 10/140 | 8,02 |
| 135007601 | 3/4" 6 Bar | 10/140 | 8,02 |
| 135010151 | 1" 1.5 Bar | 10/60 | 11,91 |
| 135010201 | 1" 2 Bar | 10/60 | 11,91 |
| 135010251 | 1" 2.5 Bar | 10/60 | 11,91 |
| 135010301 | 1" 3 Bar | 10/60 | 11,91 |
| 135010401 | 1" 4 Bar | 10/60 | 11,91 |
| 135010501 | 1" 5 Bar | 10/60 | 11,91 |
| 135010601 | 1" 6 Bar | 10/60 | 11,91 |

IVR 351

NEW



Valvola di sicurezza F/F - con attacco manometro 1/4"
Safety valve F/F with manometer connection
Sicherheitsventil IG/IG mit Druckmesseranschluss
Soupape de sécurité F/F avec fixation manomètre
Предохранительный клапан В/В - с соединением для манометра 1/4"

| Cod./Code | Misura/Size | □/田 | € |
|-----------|--------------|--------|------|
| 135105151 | 1/2" 1.5 Bar | 10/150 | 6,74 |
| 135105201 | 1/2" 2 Bar | 10/150 | 6,74 |
| 135105251 | 1/2" 2.5 Bar | 10/150 | 6,74 |
| 135105301 | 1/2" 3 Bar | 10/150 | 6,74 |
| 135105401 | 1/2" 4 Bar | 10/150 | 6,74 |
| 135105501 | 1/2" 5 Bar | 10/150 | 6,74 |
| 135105601 | 1/2" 6 Bar | 10/150 | 6,74 |

IVR 347

NEW



Valvola di sicurezza doppia funzione - temperatura e pressione attacchi filettati MF
Double-use safety valve - temperature and pressure M/F
Sicherheitsventil mit doppeltem Einsatz - Temperatur und Druck, AG/IG
Soupape de sécurité avec double fonction - température et pression, M/F
Двухфункциональный предохранительный клапан (температура и давление), резьбовые соединения Н/В

| Cod./Code | Misura/Size | T° | PN | □/田 | € |
|-----------|-------------|-------|-------|------|-------|
| 134705053 | 1/2" x 1/2" | 90 °C | 3 bar | 1/24 | 34,35 |
| 134705054 | 1/2" x 1/2" | 90 °C | 4 bar | 1/24 | 34,35 |
| 134705056 | 1/2" x 1/2" | 90 °C | 6 bar | 1/24 | 34,35 |
| 134705057 | 1/2" x 1/2" | 90 °C | 7 bar | 1/24 | 34,35 |
| 134705058 | 1/2" x 1/2" | 90 °C | 8 bar | 1/24 | 34,35 |
| 134707053 | 3/4" x 1/2" | 90 °C | 3 bar | 1/24 | 34,13 |
| 134707054 | 3/4" x 1/2" | 90 °C | 4 bar | 1/24 | 34,13 |
| 134707056 | 3/4" x 1/2" | 90 °C | 6 bar | 1/24 | 34,13 |
| 134707057 | 3/4" x 1/2" | 90 °C | 7 bar | 1/24 | 34,13 |
| 134707058 | 3/4" x 1/2" | 90 °C | 8 bar | 1/24 | 34,13 |
| 134707073 | 3/4" x 3/4" | 90 °C | 3 bar | 1/24 | 37,46 |
| 134707074 | 3/4" x 3/4" | 90 °C | 4 bar | 1/24 | 37,46 |
| 134707076 | 3/4" x 3/4" | 90 °C | 6 bar | 1/24 | 37,46 |
| 134707077 | 3/4" x 3/4" | 90 °C | 7 bar | 1/24 | 37,46 |
| 134707078 | 3/4" x 3/4" | 90 °C | 8 bar | 1/24 | 37,46 |

IVR 354

NEW



Valvola di sicurezza doppia funzione - temperatura e pressione attacchi M e raccordo a bicono per tubo rame
Double-use safety valve - temperature and pressure M and copper compression connection
Sicherheitsventil mit doppeltem Einsatz - Temperatur und Druck, AG und Kupfer-Kompressionsverbindung
Soupape de sécurité avec double fonction - température et pression, M et raccord à compression pour tube en cuivre
Двухфункциональный предохранительный клапан - (температура и давление), Наружный фитинг с двойным конусом для медной трубы

| Cod./Code | Misura/Size | T° | PN | □/田 | € |
|-----------|-------------|-------|-------|------|-------|
| 135405153 | 1/2" x 15 | 90 °C | 3 bar | 1/24 | 35,44 |
| 135405154 | 1/2" x 15 | 90 °C | 4 bar | 1/24 | 35,44 |
| 135405156 | 1/2" x 15 | 90 °C | 6 bar | 1/24 | 35,44 |
| 135405157 | 1/2" x 15 | 90 °C | 7 bar | 1/24 | 35,44 |
| 135405158 | 1/2" x 15 | 90 °C | 8 bar | 1/24 | 35,44 |
| 135407153 | 3/4" x 15 | 90 °C | 3 bar | 1/24 | 37,20 |
| 135407154 | 3/4" x 15 | 90 °C | 4 bar | 1/24 | 37,20 |
| 135407156 | 3/4" x 15 | 90 °C | 6 bar | 1/24 | 37,20 |
| 135407157 | 3/4" x 15 | 90 °C | 7 bar | 1/24 | 37,20 |
| 135407158 | 3/4" x 15 | 90 °C | 8 bar | 1/24 | 37,20 |
| 135407223 | 3/4" x 22 | 90 °C | 3 bar | 1/24 | 41,36 |
| 135407224 | 3/4" x 22 | 90 °C | 4 bar | 1/24 | 41,36 |
| 135407226 | 3/4" x 22 | 90 °C | 6 bar | 1/24 | 41,36 |
| 135407227 | 3/4" x 22 | 90 °C | 7 bar | 1/24 | 41,36 |
| 135407228 | 3/4" x 22 | 90 °C | 8 bar | 1/24 | 41,36 |

IVR 369

NEW



Valvola di sicurezza a squadra a tenuta metallica
Angle safety valve with metallic sealing
Eckförmiges Sicherheitsventil mit Metaldichtung
Soupape de sécurité équerre avec obturateur métallique
Угловой предохранительный клапан с металлическим уплотнением

| Cod./Code | Misura/Size | □/田 | € |
|-----------|-------------|-----|--------|
| 136905001 | 1/2" | 50 | 23,44 |
| 136907001 | 3/4" | 40 | 32,81 |
| 136910001 | 1" | 25 | 44,25 |
| 136912001 | 1" 1/4 | 15 | 67,31 |
| 136915001 | 1" 1/2 | 10 | 86,25 |
| 136920001 | 2" | 5 | 115,13 |

IVR 352

NEW



Valvola di sicurezza per scaldabagni - tipo leggero
Safety valve for water heaters - light version
Sicherheitsventil für Wasserkessel - leichte Ausführung
Soupape de sécurité pour chauffe eau - variante légère
Предохранительный клапан для водонагревателей - облегченная версия

| Cod./Code | Misura/Size | □/田 | € |
|-----------|-------------|--------|------|
| 135205001 | 1/2" | 25/300 | 4,65 |

IVR 352/L

NEW



Valvola di sicurezza con leva per scaldabagni - tipo leggero
Safety valve for water heaters - light version
Sicherheitsventil für Wasserkessel - leichte Ausführung
Soupape de sécurité pour chauffe eau - variante lourde
Предохранительный клапан с ручкой "флажок" для водонагревателей - облегченная версия

| Cod./Code | Misura/Size | □/田 | € |
|-----------|-------------|-----|------|
| 135205002 | 1/2" | 250 | 4,65 |

IVR 353

NEW



Valvola di sicurezza per scaldabagni - tipo pesante
Safety valve for water heaters - heavy version
Sicherheitsventil für Wasserkessel - schwere Ausführung
Soupape de sécurité pour chauffe eau - variante lourde
Предохранительный клапан для водонагревателей - усиленная версия

| Cod./Code | Misura/Size | □/田 | € |
|-----------|-------------|-----|------|
| 135305001 | 1/2" | 200 | 6,60 |

IVR 353/L

NEW



Valvola di sicurezza con leva per scaldabagni - tipo pesante
 Safety valve for water heaters - heavy version
 Sicherheitsventil für Wasserkessel - schwere Ausführung
 Soupape de sécurité pour chauffe eau - variante lourde
 Предохранительный клапан с ручкой "флажок" для водонагревателей - усиленная версия

| Cod./Code | Misura/Size | □/田 | € |
|-----------|-------------|-----|------|
| 135305002 | 1/2" | 150 | 7,50 |

IVR 103



Rubinetto per scarico caldaia serie pesante con quadro di manovra e cappuccio con chiave incorporata; attacco F
 Heavy boiler blow-off valve. Fastenings F - hose connect
 KFE-Hahn - schwere Ausführung - mit Schalttafel und Kappe mit integriertem Schlüssel - Anschluss IG
 Robinet d'évacuation chaudière série lourde avec tableau de manoeuvre et capuchon à clé intégrée - fixation F
 Усиленный сливной клапан для котла тяжелой серии с квадратной управляющей головкой и крышкой со встроенным ключом. Соединение В

| Cod./Code | Misura/Size | ∅ | □/田 | € |
|-----------|-------------|----|-------|-------|
| 110305001 | 1/2"x3/4" | 10 | 10/60 | 10,52 |
| 110307001 | 3/4"x1" | 15 | 10/60 | 16,12 |
| 110310001 | 1" | 25 | 10/40 | 24,46 |

IVR 105



Rubinetto per scarico caldaia serie pesante con quadro di manovra e cappuccio con chiave incorporata attacco M
 Heavy boiler blow-off valve. Fastenings M - hose connect
 KFE-Hahn - schwere Ausführung - mit Schalttafel und Kappe mit integriertem Schlüssel - Anschluss AG
 Robinet d'évacuation chaudière série lourde avec tableau de manoeuvre et capuchon à clé intégrée - fixation M
 Усиленный сливной клапан для котла тяжелой серии с квадратной управляющей головкой и крышкой со встроенным ключом. Соединение Н

| Cod./Code | Misura/Size | ∅ | □/田 | € |
|-----------|-------------|----|-------|-------|
| 110505001 | 1/2"x3/4" | 10 | 10/60 | 10,89 |
| 110507001 | 3/4"x1" | 15 | 10/60 | 16,47 |
| 110510001 | 1" | 25 | 10/40 | 25,40 |

IVR 904



Rubinetto per scarico caldaia completo di tappo; attacchi M - portagomma - leva nera
 Boiler blow-off valve complete with hose tail and plug - Fastenings M - hose connect - black handle
 KFE-Hahn mit Deckel - Anschlüsse AG - Schlauchanschluss - schwarzer Griff
 Robinet d'évacuation chaudière avec bouchon - fixations M - porte tuyau souple - Poignée noire
 Сливной кран для котла в комплекте с заглушкой и соединением под шланг. Соединение Н - черная ручка-флажок

| Cod./Code | Misura/Size | ∅ | □/田 | € |
|-----------|-------------|----|--------|------|
| 190403001 | 3/8"x3/4" | 8 | 40/160 | 4,78 |
| 190405001 | 1/2"x3/4" | 10 | 40/160 | 5,12 |
| 190407001 | 3/4"x1" | 15 | 20/100 | 7,74 |

IVR 905



Rubinetto per scarico caldaia completo di tappo; attacchi M - portagomma - leva rossa e guarnizione di tenuta

Boiler blow-off valve complete with hose tail and plug - Fastenings M - hose connect - red handle and seal

KFE-Hahn mit Deckel - Anschlüsse AG - Schlauchanschluss - roter Griff und Dichtung

Robinet d'évacuation chaudière avec bouchon - fixations M - porte tuyau souple - poignée rouge et joint étanchéité

Сливной кран для котла в комплекте с заглушкой и соединением под шланг. Соединение Н - красная ручка-флажок и прокладка

| Cod./Code | Misura/Size | Ø | □/⊞ | € |
|-----------|-------------|----|--------|------|
| 190505001 | 1/2"x3/4" | 10 | 20/100 | 6,49 |

IVR 62



Rubinetto per scarico caldaia serie pesante, con tappo, attacco F

Heavy boiler blow-off valve. F threads with plug

KFE-Hahn schwere Ausführung mit Kappe Anschluss IG

Robinet d'évacuation chaudière type lourd fixation F et bouchon

Сливной кран для котла тяжелой серии, с заглушкой, соединение В

| Cod./Code | Misura/Size | □/⊞ | € |
|-----------|------------------------------|-------|------|
| 106205001 | 1/2" scarico caldaia Fem Nic | 10/60 | 6,37 |
| 106205011 | 1/2" scarico caldaia Fem Gia | 10/60 | 6,22 |

IVR 64



Rubinetto per scarico caldaia serie pesante, con tappo, attacco M

Heavy boiler drain valve with cap and M connection

KFE-Hahn mit Kappe - Anschluss AG

Robinet d'évacuation chaudière type lourd avec bouchon - fixation M

Сливной кран для котла тяжелой серии, с заглушкой, соединение Н

| Cod./Code | Misura/Size | □/⊞ | € |
|-----------|------------------------------|-------|------|
| 106405001 | 1/2" scarico caldaia Mas Nic | 10/60 | 6,83 |
| 106405011 | 1/2" scarico caldaia Mas Gia | 10/60 | 6,67 |

IVR 149

NEW



Rubinetto porta manometro M/F con premistoppa e foro di spurgo, maniglia termoplastica
 Manometer holder M/F with packing nut and drain hole, handle in thermoplastic
 Manometerhalter AG/IG mit Stopfbüchse und Ablassbohrung und Griff aus Thermoplastik
 Robinet porte-manomètre M/F avec presse-étoupe et purge, poignée en thermoplastique
 Кран для установки манометра, соединения Н/В, с сальником, выпускным отверстием, термопластиковая ручка

| Cod./Code | Misura/Size | □/田 | € |
|-----------|-------------|-------|-------|
| 114902001 | 1/4" | 10/60 | 12,34 |
| 114903001 | 3/8" | 10/60 | 12,71 |
| 114905001 | 1/2" | 10/60 | 13,91 |

IVR 150

NEW



Rubinetto porta manometro M/F con premistoppa, flangia e tappo su flangia e foro di spurgo, maniglia termoplastica

Manometer holder M/F with packing nut, flange and cap on the flange, handle in thermoplastic
 Manometerhalter AG/IG mit Stopfbüchse, Flansche und Deckel auf der Flansche, Griff aus Thermoplastik
 Robinet porte-manomètre M/F avec presse-étoupe, bride et bouchon sur la bride, poignée en thermoplastique

Кран для установки манометра, соединения Н/В, с сальником, выпускным отверстием, фланцем и заглушкой на фланце, термопластиковая ручка

| Cod./Code | Misura/Size | □/田 | € |
|-----------|-------------|-------|-------|
| 115002001 | 1/4" | 10/60 | 15,11 |
| 115003001 | 3/8" | 10/60 | 15,90 |
| 115005001 | 1/2" | 10/60 | 17,48 |

IVR 909

NEW



Defangatore magnetico completo di tappo, bocchettoni e rubinetto di scarico
 Dirt separator with magnet, cap, fittings and drain cock with hose connection
 Séparateur de boue magnétique avec bouchon, raccords et robinet de vidange avec tétine
 Schlammabscheider mit magnet, kappe, anschluss-stuck und entleerungshahn mit schlauch-anschluss
 Магнитный грязеуловитель (дешламатор) с заглушкой, фитингами и сливным краном с насадкой для шланга

| Cod./Code | Misura/Size | □/田 | € |
|-----------|-------------|-----|-------|
| 190907000 | 3/4" | 1/6 | 88,00 |